



## 1、 Specifications

1	规格型号 Holder Type	HC-49SBSMD
2	标称频率 Nominal Frequency	9.000MHz
3	振动模式 Mode of Oscillation	基频
4	调整频差 Frequency Tolerance at 25°C	±20ppm
5	温度频差 Temperature Frequency Stability	±30ppm
6	工作温度 Operating Temperature Range	-20~70°C
7	贮存温度 Storage Temperature Range	-40~90°C
8	负载电容 Load Capacitance	12 pF
9	静电容 Shunt capacitance	≤7 pf
10	等效电阻 Equivalent Series Resistance	80 Ω Max
11	激励功率 Drive Level	50 uW
12	绝缘阻抗 Insulation Resistance	500MΩ min./DC100V

## 2、 Frequency stability over temperature range (AT cut)

Temperature Range	Frequency Stability							
	±3PPM	±5PPM	±7.5PPM	±10PPM	±20PPM	±30PPM	±50PPM	±70PPM
0°C~+50°C	☆	☆	☆	☆	☆	☆	☆	☆
-10°C~+60°C			☆	☆	☆	☆	☆	☆
-20°C~+70°C				☆	☆	★	☆	☆
-30°C~+70°C					☆	☆	☆	☆
-40°C~+85°C						☆	☆	☆
-40°C~+125°C						☆	☆	☆

### 3、Dimensions (unit:mm)

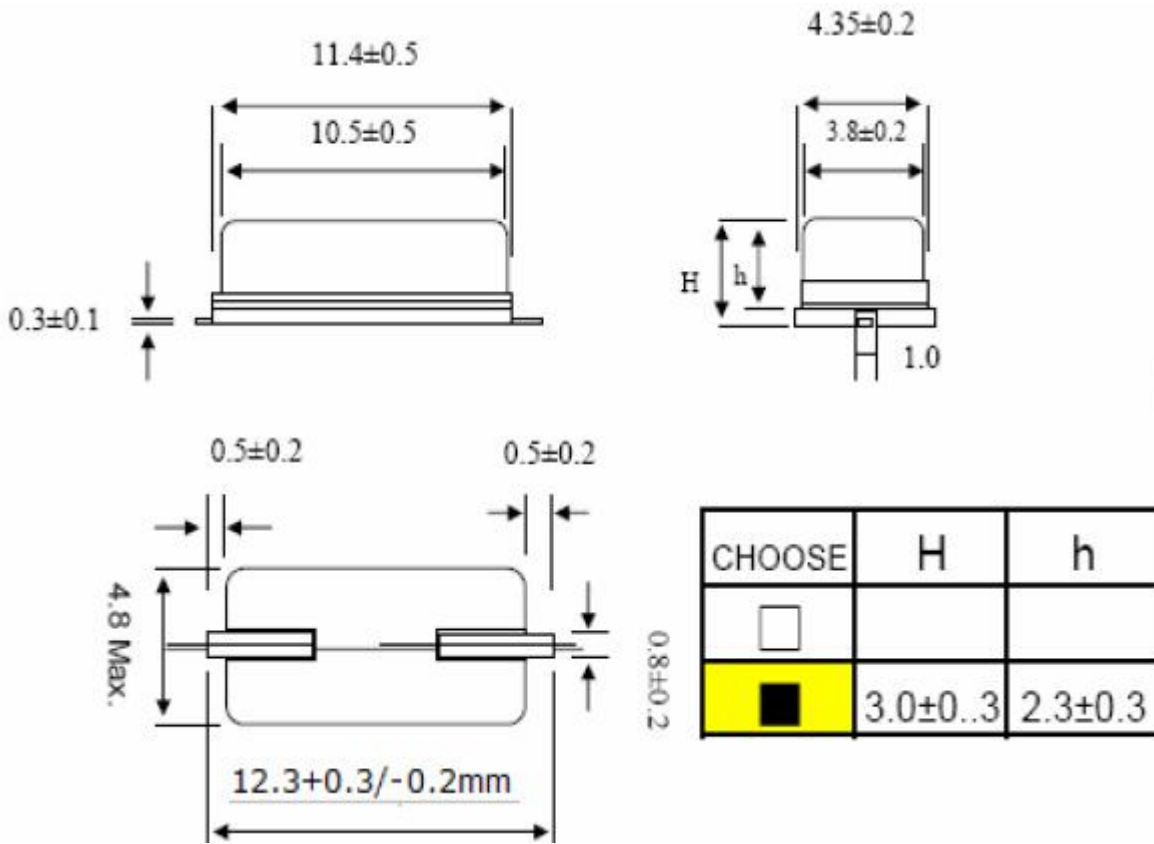

### 4、 Recommended Reflow profile

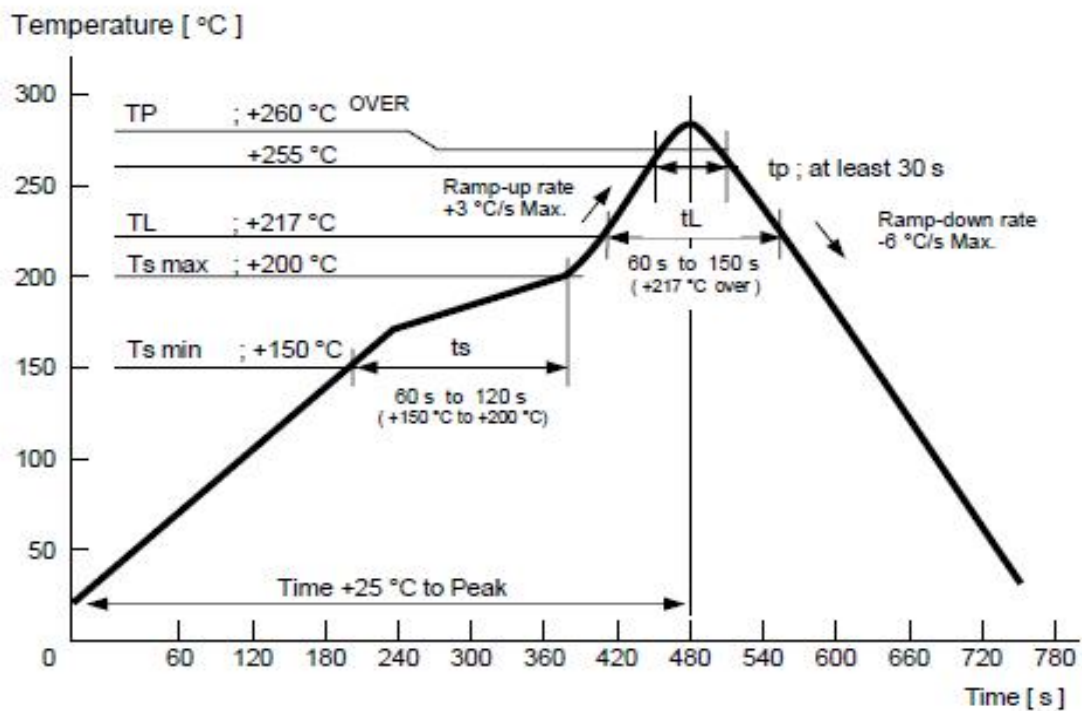

## 5、Reliability specifications

NO	Item	Condition	Standard
1.	Drop Test	Free drop from 50cm height on a hard wooden board for 3 times. (Board is thickness more than 30 mm.)	Frequency change: ≤5ppm Rr as specification
2.	Mechanical Shock	Half sine wave, 1000G, 0.5mS, three times for all 3 directions	Frequency change: ≤5ppm Rr as specification
3.	Vibration	Frequency range:10~55hz Amplitude:1.52mm Sweep time:1mintutes perpendicular axes each test time:2Hrs	Frequency change: ≤5ppm Rr as specification
4.	Solderability	Temperature:245℃±5℃ Immersing depth:0.5mm minimum Immersion time:5±1sec. Flux:Rosin resin methyl alcohol solvent(1:4)	90% exhibit tin ok
5.	Resistance to soldering heat	Test temperature:260℃±5℃ Test time :10±1sec.	Frequency change: ≤10ppm Rr as specification
6.	High Temp & Humidity	85±3℃ & RH85%, 500±12 hours	Frequency change: ≤10ppm Rr as specification
7.	Low temperature storage	-40±3℃, 500±12 hours	Frequency change: ≤10ppm Rr as specification
8.	High temperature storage	+85±3℃, 500±12 hours	Frequency change: ≤10ppm Rr as specification
9.	Temperature cycling	-40±3℃/10min~+85±3℃/10min, 100cycles	Frequency change: ≤10ppm Rr as specification

6、Tape & Reel ( unit: mm )



A	B	C	D	E	F
1.55±0.1	4.0±0.1	12.0±0.1	11.5±0.1	24.0±0.3	3.5±0.2

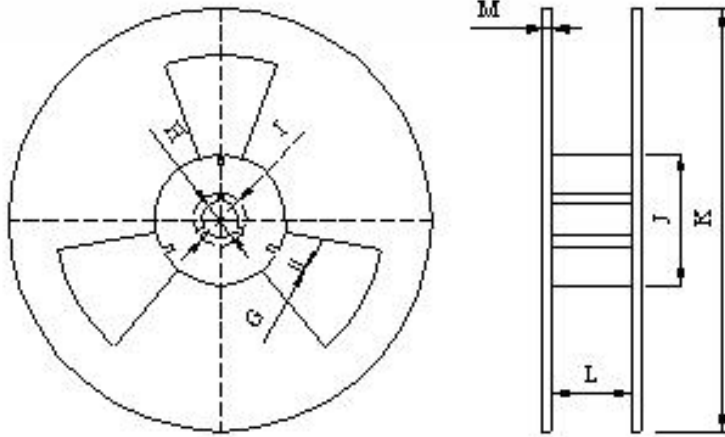

G	H	I	J	K	L	M
2.2±0.5	13.0±0.2	20.2±1.0	100.0±1.0	330±2.0	24.5±0.3	2.3±0.5

## 7、Packing

1. 每盘数量 Capacity of a plastic reel : 1000 PCS
2. 每内箱数量 Capacity per inner box : 1000 PCS (A reel inner)
3. 每大箱数量 Capacity per outer carton : 10000 PCS (10× inner box) .

