



MD83XX is a high voltage (up to 40V) low power low dropout voltage regulator (LDO) manufactured in CMOS processes. It can deliver up to 300mA of current while consuming only 1.5uA of quiescent current. It consists of a reference voltage generator, an error amplifier, a current foldback circuit, and a phase compensation circuit plus a driver transistor.

**■ FEATURES**

- Ultra-low Quiescent Current: 1.5uA
- Maximum Input Voltage: 40V
- Output Voltage Highly Accurate:  $\pm 2\%$
- Maximum Output Current: 300mA
- Dropout Voltage: 4mV@ $I_{OUT}=1\text{mA}$
- Temperature Stability:  $\pm 50\text{ppm}/^\circ\text{C}$
- Protections Circuits: Current Limiter, Short Circuit, Foldback, Thermal shutdown
- Output Capacitor: Low ESR Ceramic Capacitor Compatible

**■ APPLICATIONS**

- Smart wearer
- Long-life battery-powered devices
- Portable mobile devices, such as mobile phones, cameras, and so on
- Wireless communication equipment

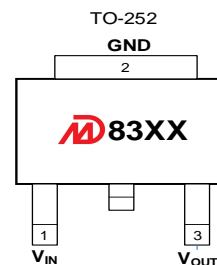
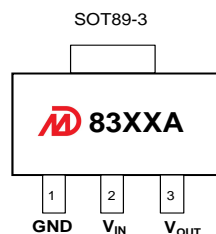
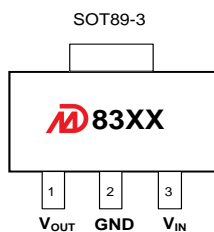
**■ PIN CONFIGURATION (TOP VIEW)**

## ■ Product Selections

Type	Output Voltage (note 1*)	Current Limit	Accuracy	Package (note 2*)	MARKING (note 3*)
MD83XX	2.1V	550mA	±2%	SOT89-3	Ⓜ 8321A
	2.5V	550mA	±2%	SOT89-3	Ⓜ 8325A/ Ⓜ 8325
	2.7V	550mA	±2%	SOT89-3	Ⓜ 8327A
	2.8V	550mA	±2%	SOT89-3	Ⓜ 8328A
	3.0V	550mA	±2%	SOT89-3	Ⓜ 8330A/ Ⓜ 8330
	3.3V	550mA	±2%	SOT89-3	Ⓜ 8333A/ Ⓜ 8333
	3.6V	550mA	±2%	SOT89-3	Ⓜ 8336A/ Ⓜ 8336
	3.8V	550mA	±2%	SOT89-3	Ⓜ 8338A
	4.0V	550mA	±2%	SOT89-3	Ⓜ 8340A/ Ⓜ 8340
	4.1V	550mA	±2%	SOT89-3	Ⓜ 8341A
	4.4V	550mA	±2%	SOT89-3	Ⓜ 8344A/ Ⓜ 8344
	5.0V	550mA	±2%	SOT89-3	Ⓜ 8350A/ Ⓜ 8350
	5.3V	550mA	±2%	SOT89-3	Ⓜ 8353
	5.5V	550mA	±2%	SOT89-3	Ⓜ 8355A/ Ⓜ 8355
	5.7V	550mA	±2%	SOT89-3	Ⓜ 8357
	6.0V	550mA	±2%	SOT89-3	Ⓜ 8360
	10V	550mA	±2%	SOT89-3	Ⓜ 8310A/ Ⓜ 8310
12V	550mA	±2%	SOT89-3	Ⓜ 8312A/ Ⓜ 8312	

### Notes:

1\* Customer can request to customize the output voltage ranged from 1.2V to 15V if desired voltage is not found in the selections.

2\* Customer can request customization of package choice.

3\* Please pay attention to the MARKING of the product package type.

## ■ Absolute Maximum Ratings (Unless otherwise indicated: T<sub>a</sub>=25°C)

PARAMETER	SYMBOL	RATINGS		UNITS
Input Voltage	V <sub>IN</sub>	-0.3 ~ 45		V
Output Voltage	V <sub>OUT</sub>	V <sub>SS</sub> -0.3 ~ V <sub>IN</sub> +0.3V		
Power Dissipation	P <sub>D</sub>	SOT89-3	500	mW
		TO252	1800	
Thermal Resistance	R <sub>θJB</sub> <sup>(1)</sup>	SOT89-3	100	°C/W
		TO252	55	
Operating Ambient Temperature	T <sub>opr</sub>	-40 ~ +85		°C
Storage Temperature	T <sub>stg</sub>	-40 ~ +125		
ESD Protection	ESD HBM	1500		V

**Note:** Stresses above those listed under "Absolute Maximum Ratings" may cause permanent damage to the device.

<sup>(1)</sup> Mounted on JEDEC standard 4layer (2s2p) PCB test board

## ■ ELECTRICAL CHARACTERISTICS

MD83XX Series (Unless otherwise indicated:  $T_a=25^\circ\text{C}$ )

PARAMETER	SYMBOL	CONDITIONS	MIN.	TYP.	MAX.	UNIT	
Output Voltage*1	$V_{OUT(S)}$	$V_{IN} = V_{OUT(S)} + 2V, I_{OUT} = 10\text{mA}$	$V_{OUT(S)} \times 0.98$	$V_{OUT(S)}$	$V_{OUT(S)} \times 1.02$	V	
Dropout Voltage*2	$V_{DROP}$	$V_{OUT(S)} = 3.3V, I_{OUT} = 1\text{mA}$		4	8	mV	
		$V_{OUT(S)} = 3.3V, I_{OUT} = 300\text{mA}$		1300	1950		
Line Regulation	$\frac{\Delta V_{OUT}}{\Delta V_{IN} \cdot V_{OUT(S)}}$	$V_{OUT(S)} + 2V \leq V_{IN} \leq 40V, I_{OUT} = 1\text{mA}$		0.01	0.02	%/V	
Load Regulation	$\Delta V_{OUT2}$	$V_{IN} = V_{OUT(S)} + 2V, 1\text{mA} \leq I_{OUT} \leq 300\text{mA}$	$V_{OUT(S)} \leq 5.3V$	20	40	mV	
			$V_{OUT(S)} > 5.3V$	50	80		
Temperature Stability	$\frac{\Delta V_{OUT}}{\Delta T_a \cdot V_{OUT(S)}}$	$V_{IN} = V_{OUT(S)} + 2V, I_{OUT} = 10\text{mA}, -40^\circ\text{C} \leq T_a \leq 125^\circ\text{C}$		$\pm 50$		ppm/°C	
GND Current	$I_{GND}$	no load	$V_{OUT(S)} < 3.0V$	0.8	1.2	2	uA
			$3.0 \leq V_{OUT(S)} \leq 5.3V$	1	1.5	2.5	
			$V_{OUT(S)} > 5.3V$	1.5	2.3	3.5	
			$I_{OUT} = 100\text{mA}$		460		
Input Voltage	$V_{IN}$	---	2.2		40	V	
Maximum Output Current	$I_{OUTMAX}$		300	350		mA	
Current Limit*3	$I_{LIM}$	$V_{IN} = V_{OUT(S)} + 2V, V_{OUT} = 0.95 \times V_{OUT(S)}$	350	550			
Short Circuit Current	$I_{SHORT}$	$V_{IN} = V_{OUT(S)} + 2.0V, V_{OUT} = 0V$		65			
Power Supply Rejection Ratio	PSRR	$f = 10\text{Hz}, V_{OUT(S)} = 3.3V$		74		dB	
		$f = 100\text{Hz}, V_{OUT(S)} = 3.3V$		63			
		$f = 1\text{kHz}, V_{OUT(S)} = 3.3V$		42			
Over Temperature Protection	OTP	$I_{OUT} = 1\text{mA}$		170		°C	

Notes:

- $V_{OUT(S)}$ : Output voltage when  $V_{IN} = V_{OUT} + 2V, I_{OUT} = 1\text{mA}$ .
- $V_{DROP} = V_{IN1} - (V_{OUT(S)} \times 0.98)$  where  $V_{IN1}$  is the input voltage when  $V_{OUT} = V_{OUT(S)} \times 0.98$ .
- $I_{LIM}$ : Output current when  $V_{IN} = V_{OUT(S)} + 2V$  and  $V_{OUT} = 0.95 \times V_{OUT(S)}$ .

## ■ TYPICAL APPLICATIONS

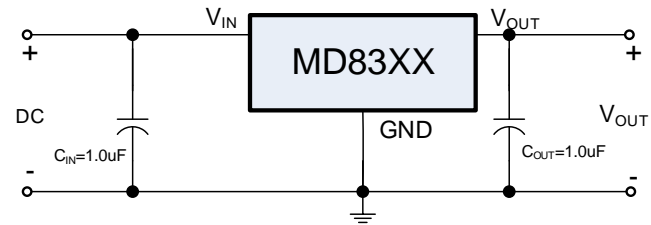

## ■ Notes on Use

Input Capacitor ( $C_{IN}$ ): 1.0 $\mu$ F above

Output Capacitor ( $C_{OUT}$ ): 1.0 $\mu$ F above

## ■ TYPICAL PERFORMANCE CHARACTERISTICS

Test Conditions:  $V_{IN}=V_{OUT}+2.0V$ ,  $C_{IN}=1.0\mu F$ ,  $C_{OUT}=1.0\mu F$ ,  $T_a=25^\circ C$ , unless otherwise indicated.

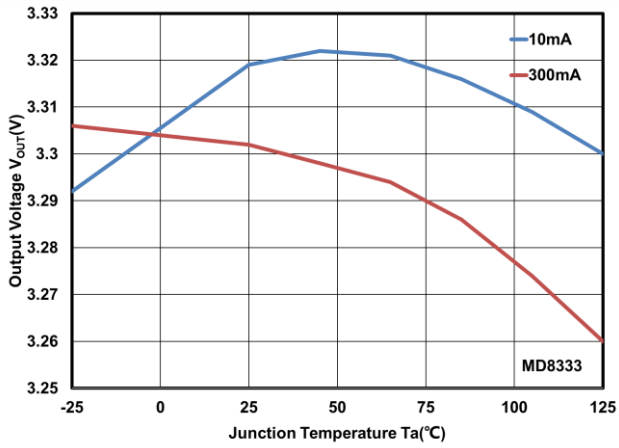

$V_{OUT}$  vs Temperature

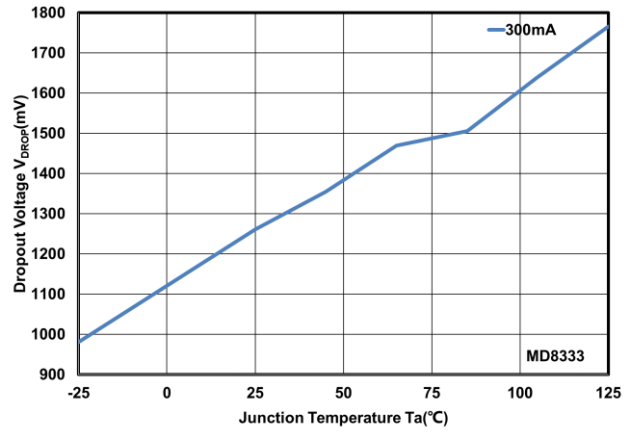

$V_{DROP}$  vs Temperature

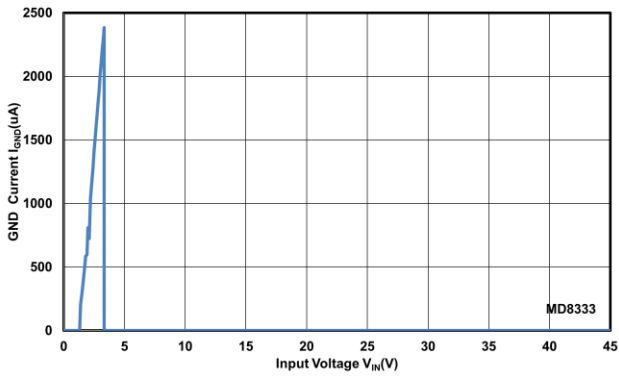

GND Current vs Input Voltage

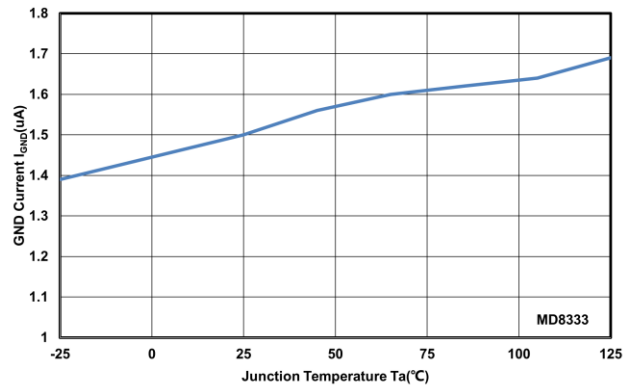

GND Current vs Temperature

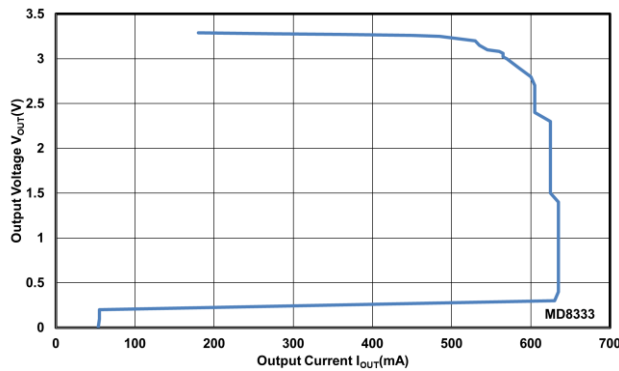

Output Current Fold-back

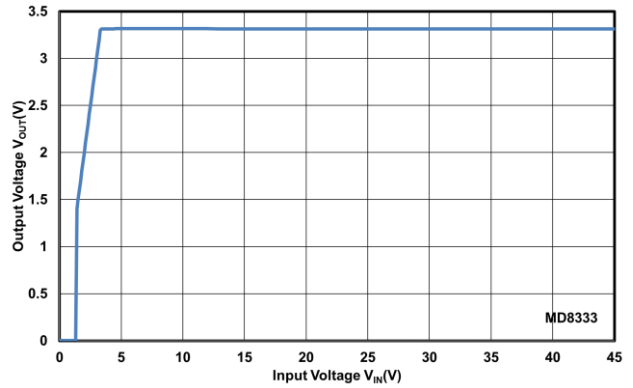

Output Voltage vs Input Voltage

## ■ TYPICAL PERFORMANCE CHARACTERISTICS(CONTINUED)

Test Conditions:  $V_{IN}=V_{OUT}+2.0V$ ,  $C_{IN}=1.0\mu F$ ,  $C_{OUT}=1.0\mu F$ , unless otherwise indicated.



GND Current vs Output Current



Power Supply Rejection Ratio



Power Supply Rejection Ratio

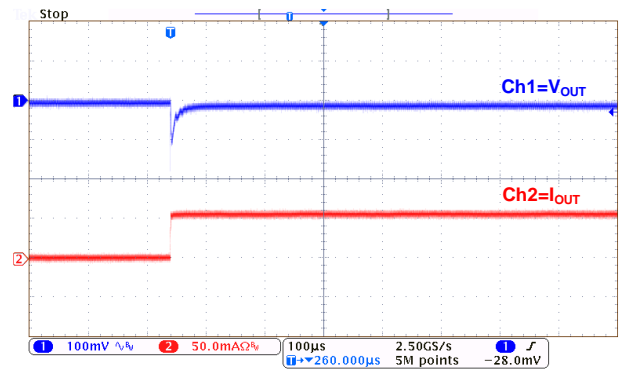

Load Transient:  
MD8333( $I_{OUT}=0mA\sim 50mA$ )

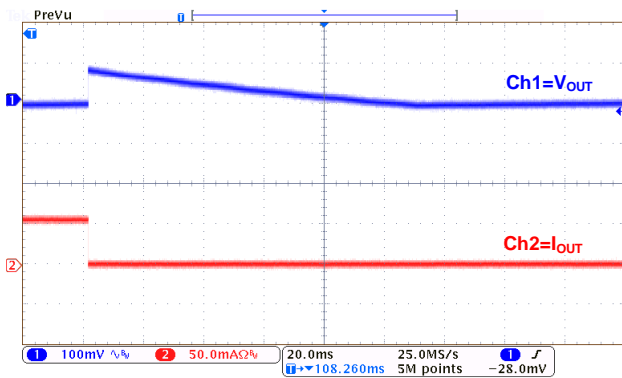

Load Transient:  
MD8333( $I_{OUT}=50mA\sim 0mA$ )

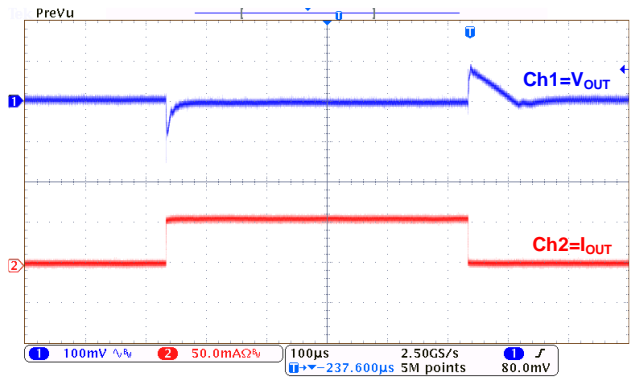

Load Transient:  
MD8333( $I_{OUT}=1mA\sim 50mA\sim 1mA$ )

## ■ TYPICAL PERFORMANCE CHARACTERISTICS(CONTINUED)

Test Conditions:  $V_{IN}=V_{OUT}+2.0V$ ,  $C_{IN}=1.0\mu F$ ,  $C_{OUT}=1.0\mu F$ ,  $T_a=25^\circ C$ , unless otherwise indicated.

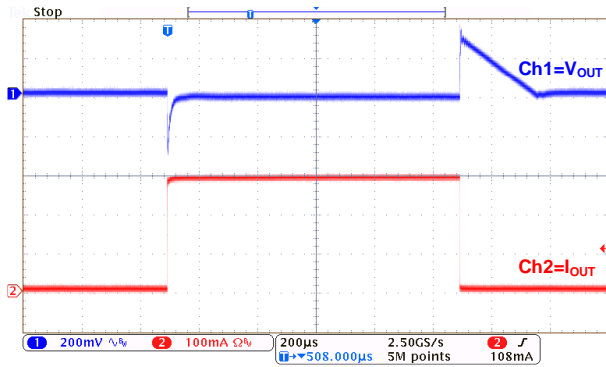

Load Transient:  
MD8333 ( $I_{OUT}=1mA\sim 300mA\sim 1mA$ )

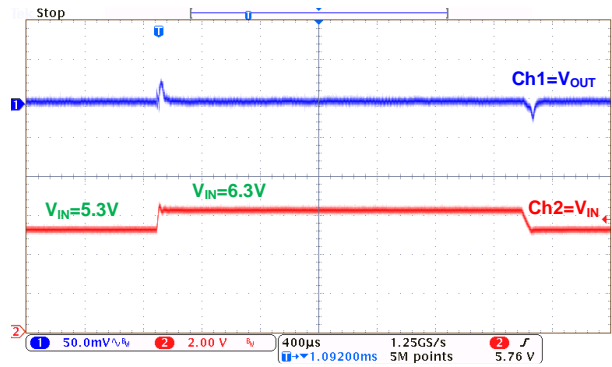

Line Transient:  
MD8333 ( $I_{OUT}=1mA$ )

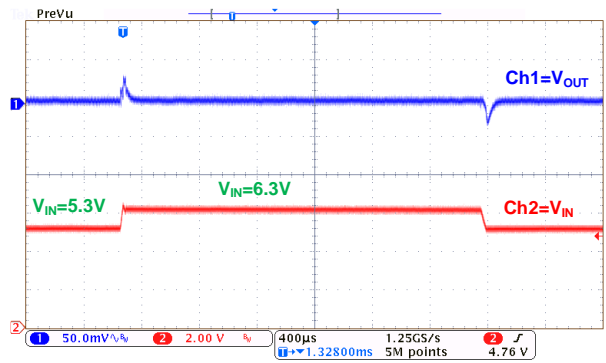

Line Transient:  
MD8333 ( $I_{OUT}=10mA$ )

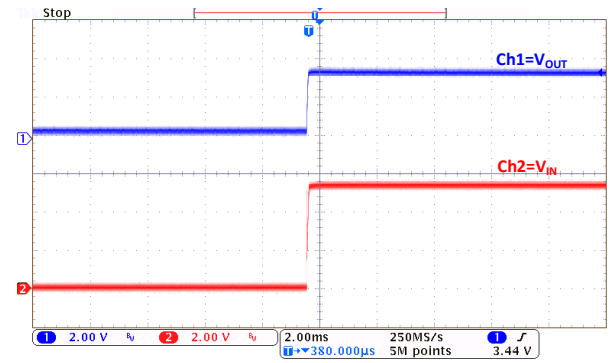

Power-Up:  
MD8333 ( $I_{OUT}=0mA$ )

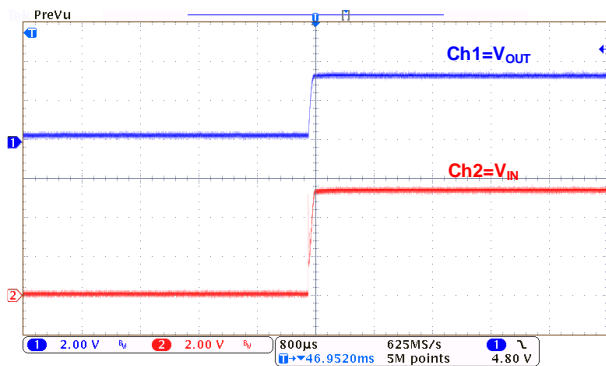

Power-Up:  
MD8333 ( $I_{OUT}=300mA$ )

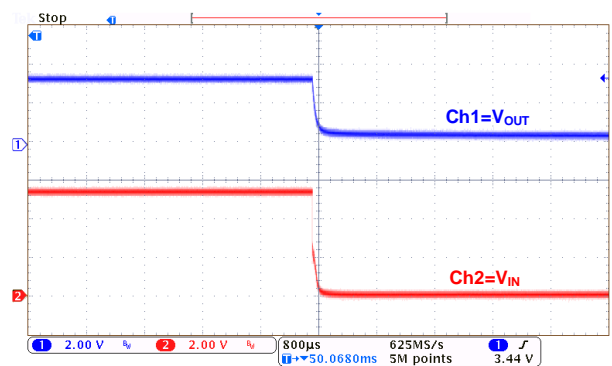

Power-Down:  
MD8333 ( $I_{OUT}=0mA$ )

## ■ TYPICAL PERFORMANCE CHARACTERISTICS(CONTINUED)

Test Conditions:  $V_{IN}=V_{OUT}+2.0V$ ,  $C_{IN}=1.0\mu F$ ,  $C_{OUT}=1.0\mu F$ ,  $T_a=25^\circ C$ , unless otherwise indicated.

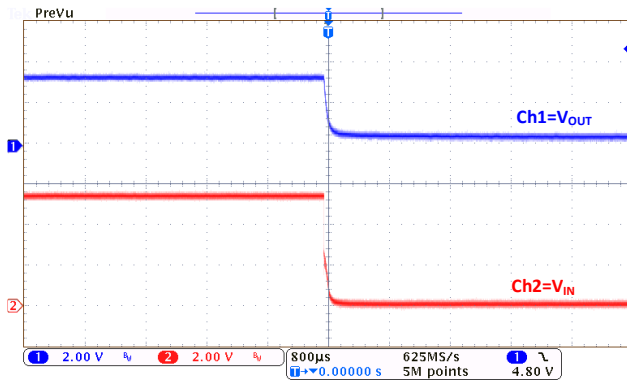

Power-Down:  
MD8333 ( $I_{OUT}=300mA$ )



## ■ OPERATIONAL EXPLANATION

### 1. Output voltage control

The voltage divided by resistors R1 and R2 is compared with the internal reference voltage by the error amplifier. The amplifier output then drives the P-channel MOSFET connected to the  $V_{OUT}$  pin. The output voltage at the  $V_{OUT}$  pin is regulated by this negative feedback system. The current limit circuit and short protect circuit operate in relation to output current level.



### 2. Pass transistor

The pass transistor with low turn-on resistance used in MD83XX is a P-channel MOSFET. If the potential on  $V_{OUT}$  pin is higher than  $V_{IN}$ , it is possible that IC will be destroyed due to reverse current which is caused by parasitic diodes between  $V_{IN}$  and  $V_{OUT}$ . Therefore, the  $V_{OUT}$  pin potential exceeds  $V_{IN}+0.3V$  is not allowed.

### 3. Current foldback, short circuit protection and over temperature protection

The MD83XX series includes a combination of a fixed current limiter circuit and a foldback circuit, which aid the operations of the current limiter and circuit protection. When the load current reaches the current limit level, the fixed current limiter circuit operates and output voltage drops. As a result of this drop in output voltage, the foldback circuit operates, output voltage drops further and output current decreases. The short circuit current is about 65mA (typical value). This design can prevent the chip be damaged due to over temperature, moreover, the heat dissipation is limited by the package type.

Special attention should be paid to that the product of the dropout voltage on the chip and the output current must be smaller than the heat dissipation. If power consumption on the chip is more than the heat dissipation, OTP will protect the chip from damaging due to over temperature.

## ■ Notes:

1. The input and output capacitors should be placed as close as possible to the IC.
2. If the impedance of the power supply is high, which is caused by forgetting installing input capacitor or installing too small value capacitor, the oscillation may occur.
3. Pay attention to the operation conditions of input and output voltage and load current, such that the power consumption in the IC should not exceed the allowable power consumption of the package even though the chip has short circuit protection.
4. IC has a built-in anti-static protection (ESD) circuit, but please do not add excessive stress to the IC.

## ■ PACKAGING INFORMATION

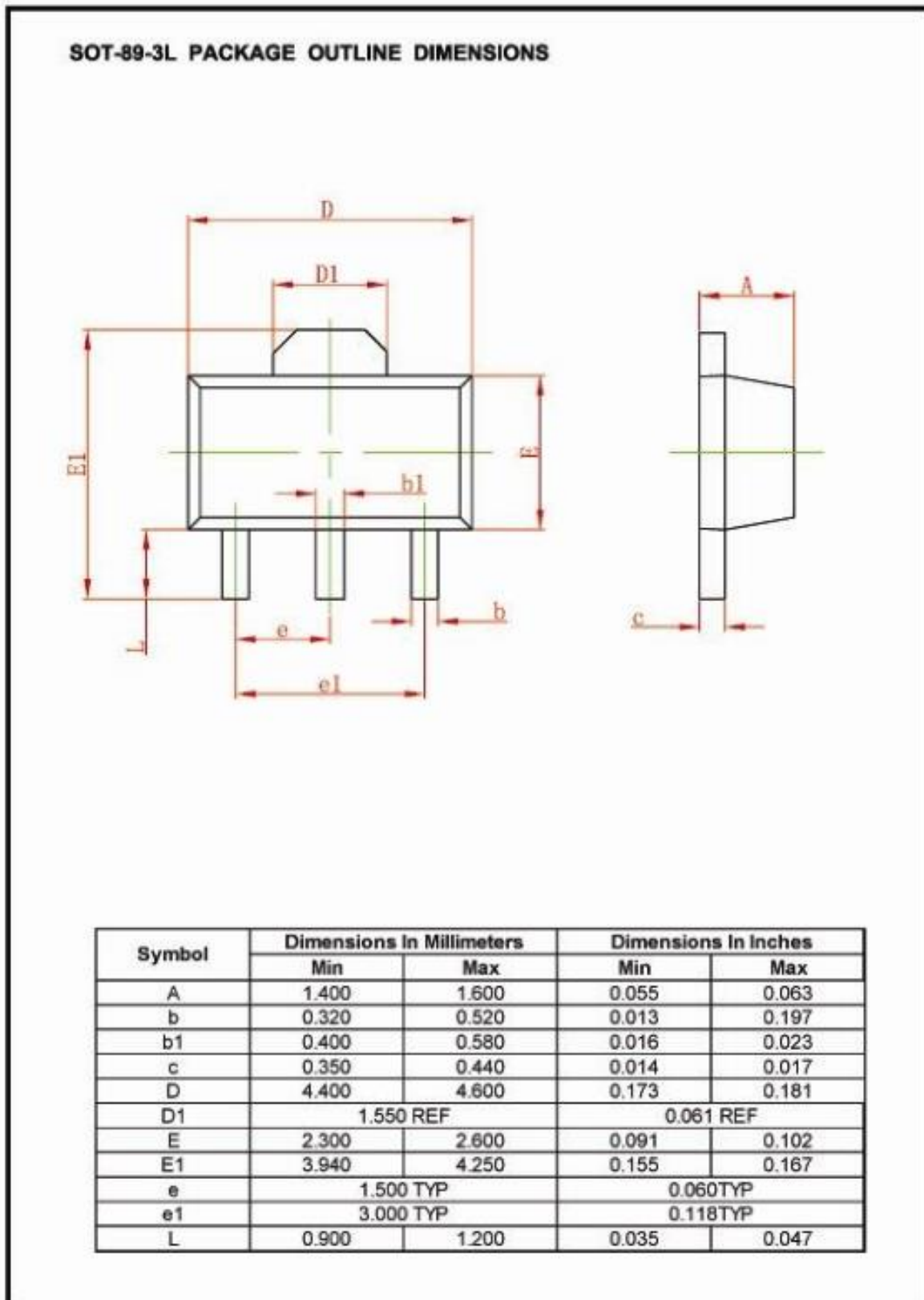

For the newest datasheet, please see the website:

[www.md-ic.com.cn](http://www.md-ic.com.cn)

Version V1.5: 20200612