





JYH HSU (JEC) ELECTRONICS LTD.,

Approved/Recognized Type

Related Standard		Certificate NO	APProved Monogram
CQC (China)	IEC 60384-14	CQC13001103539	
KC (Korea)	K60384	SU03044-9002	
UL(usa) CSA(Canada)	IEC UL 60384	E356696	
ENEC (EU)	EN 60384-14	ENEC-00984	
VDE (Germany)	EN 60384-14	40038643	
IEC CB	IEC 60384-14	US-33636-UL	

Specifications

Operating Temp.Range	-40°C to +85°C		
Use temperature range	-40°C to +125°C		
Applicable Standards	UL, CSA, CQC, ENEC, VDE,KC	X1	Y2
		400VAC	300VAC
Dielectric Withstanding Voltage	Rted Voltage		Test Voltage
	300VAC		1800V-2600 VAC for 1 min.
Dissipation Factor (D.F)	Y5P,Y5U	TANδ(DF) ≤ 2.5%,measured at 1KHz±10%,1.0 – 5.0 Vrms,25°C	
	Y5V	TANδ(DF) ≤ 5.0%,measured at 1KHz±10%,1.0 – 5.0 Vrms,25°C	
Capacitance(C)	Range	10 pF to 10000 pF. measured at 1KHz±10%, 1.0 – 5.0 Vrms, 25°C	
	Tolerance	±10%	Y5P
		±10%	Y5U
		±20%	
±20%		Y5V	
InsulationResiatance(IR)	10000 MΩ , 1 min , 500 VDC		
Temperature Characteristics	Type Code	Temp. Coeff.	Temp. Range
	Y5P	±10%	-40°C to +85°C, -40°C to +125°C
	Y5V	+30%~-89%	-40°C to +85°C, -40°C to +125°C
	Y5U	+22%~-65%	-40°C to +85°C, -40°C to +125°C

Part Number Configuration:

JY 102 K 2F Y5P S T 7.5 L

(1) (2) (3) (4) (5) (6) (编带) (7) (8)

- (1) AC capacitors, safety
- (2) Rated capacitance
- (3) Tolerance on rated capacitance
- (4) Rated Voltage
- (5) Type code : (B)Y5P, (F)Y5V, (E)Y5U
- (6) Lead shape: S(直角), I(内弯), O(外弯), X(前后弯)
- (7) Pin pitch : 7.5or9.5or10.0
- (8) Lead length: 3—30mm

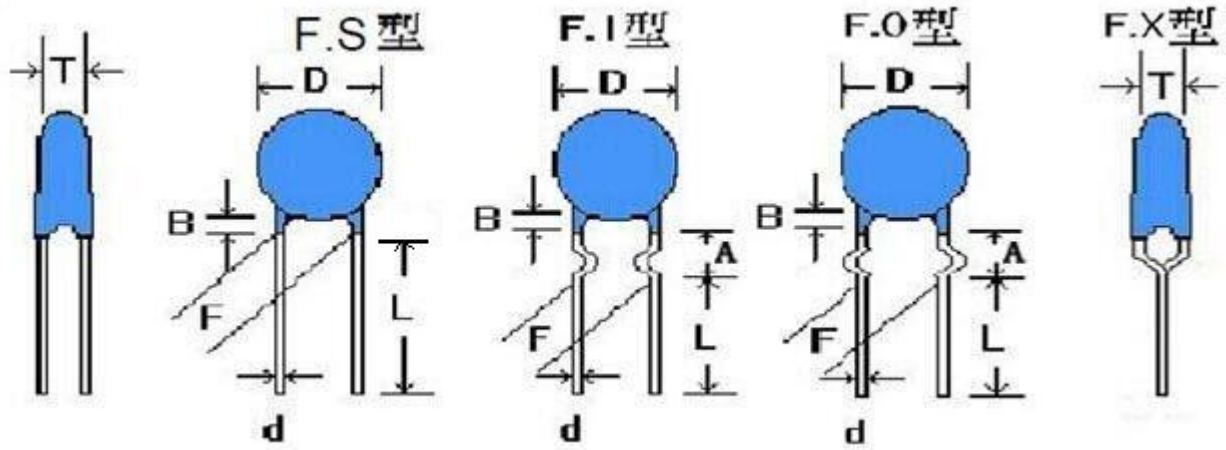

Dimensions and Tolerance

B=3.0mm max for AA

L=3-27mm

承认规格详细参数 (Approved Spec. Data)

品名规格	D(MAX)	F±0.8	L(MIN)mm	T±0.5mm	d±0.05mm	DF 值	Amm	B	备注

Marking:

- a. Trademark or Company name  JEC
- b. Product Type JY Series
- c. Nominal Capacitance 222=2200pF,
- d. Tolerance K= ±10%, M= ±20%
- e. Recognized Type cUL, CQC, VDE, ENEC, KC
- f. Rated Voltage X1=400Vac , Y2=300Vac

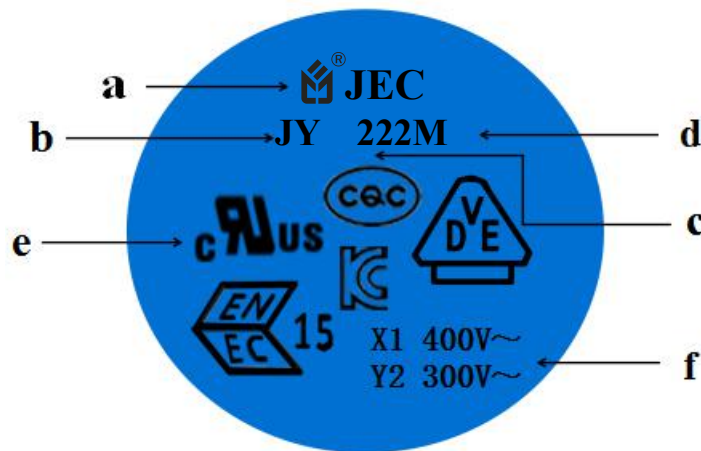

1. Packing Quantity:

Packing	Safety	High Voltage	<i>Ceramic</i>
	Capacitor	Capacitor (Y1, Y2)	<i>Capacitor DC</i>
Bulk	1000pcs	1000pcs	<i>1000pcs</i>
Tape Ammo	2000pcs	1500pcs	<i>2000pcs</i>

ROHS Compliance , SVHC

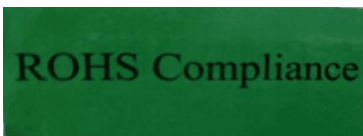

2. Packing information

2.1 the number of plastic bags in each bag is 1000 PCS. Internal label and ROHS qualification label.

2.2 the quantity of each small box is 10k-30k. 1K is a bag. It depends on the product volume.

2.3 each large box can hold two small boxes.

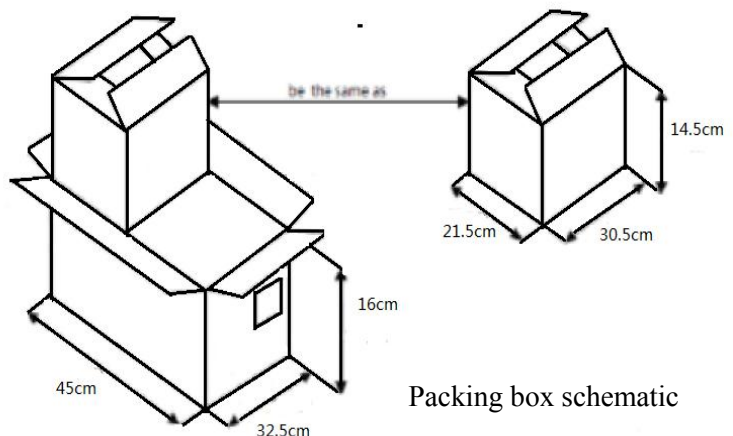

Packing box schematic

JYH HSU (JEC) ELECTRONICS LTD.,

料號編碼規定如下:

成品之編碼原則上以十五碼完成, 亦以阿拉伯數字與英文字母混合編成, 第二碼至第十一碼與瓷片相同。第一碼以 J 代表自製 (取 JEC 商標第一字)

The coding of the finished product is in principle 15 codes, which are mixed with Arabic numerals and English letters. Sizes 2 to 11 are the same as the tiles. The first code is represented by J (take the first word of JEC trademark).

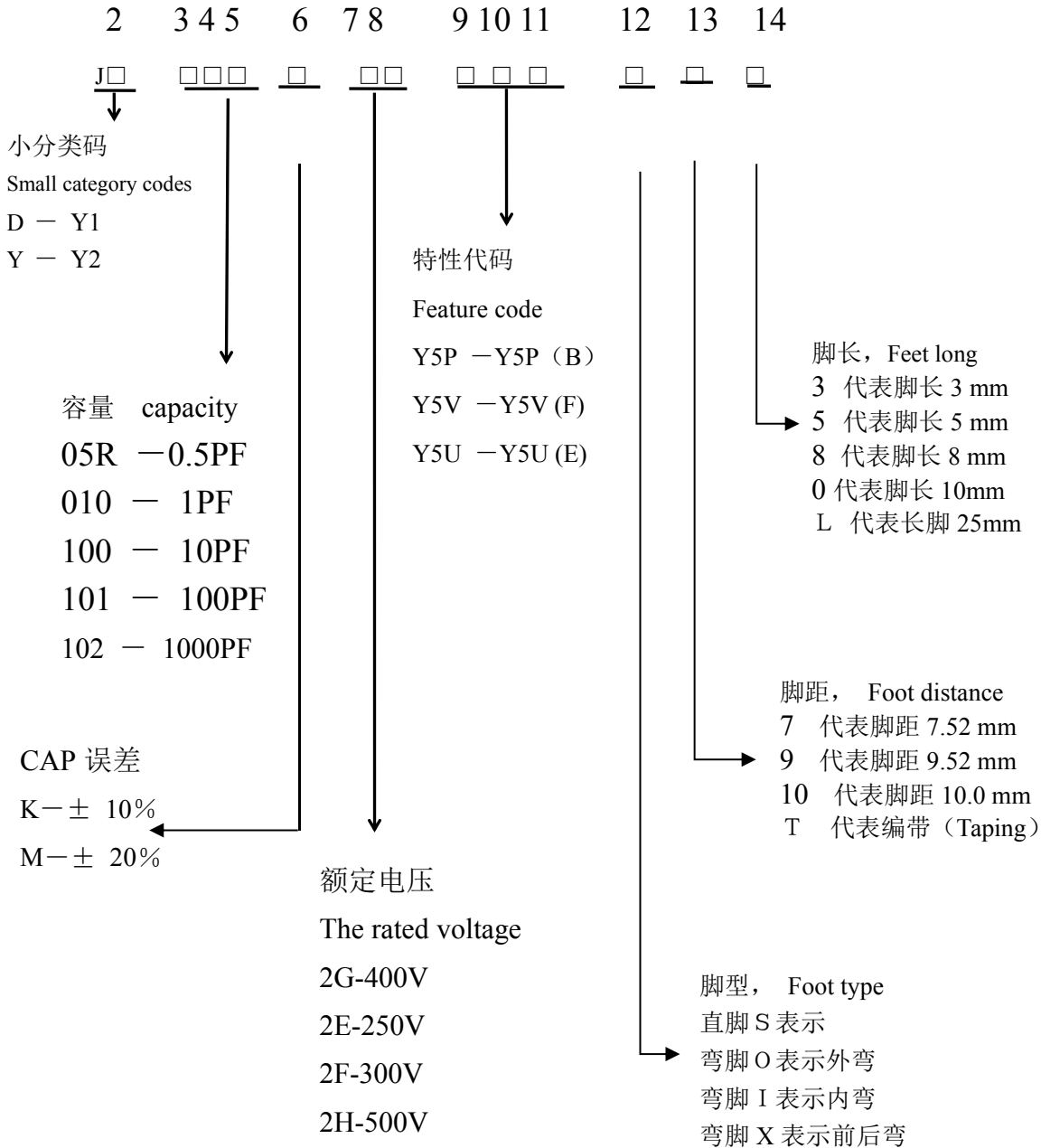

JYH HSU (JEC) ELECTRONICS LTD.,

Capacitance and Dimensions:

Part Number	T.C.	CAP.	TOL.	Dimension(mm)					
				D max	F±0.8mm			T max	Φ d(±0.05)
JY10K2FY5P To JY82K2FY5P	±10% (Y5P)	10pF To 82PF	K ±10%	6.3	7.5	9.5	10	5.0	0.55
JY101K2FY5P		100PF		6.3					
JY151K2FY5P		150PF		6.3					
JY221K2FY5P		220PF		6.3					
JY331K2FY5P		330PF		6.3					
JY471K2FY5P		470PF		6.8					
JY561K2FY5P		560PF		7.7					
JY681K2FY5P		680PF		7.7					
JY102K2FY5P		1000PF		8.8					
JY102M2FY5U		+22 ~-65% (Y5U)		1000PF					
JY152M2FY5U	1500PF		7.7						
JY222M2FY5U	2200PF		9.3						
JY332M2FY5U	3300PF		10.3						
JY472M2FY5U	4700PF		11.5						
JY102M2FY5V	+30 ~-89% (Y5V)	1000PF	M ±20%	6.3	7.5	9.5	10	5.0	0.55
JY152M2FY5V		1500PF		6.3					
JY222M2FY5V		2200PF		6.8					
JY332M2FY5V		3300PF		8.5					
JY392M2FY5V		3900PF		9.3					
JY472M2FY5V		4700PF		9.3					
JY562M2FY5V		5600PF		10.2					
JY682M2FY5V		6800PF		11.5					
JY103M2FY5V		10000PF		13.7					

注：本规格仅作参考，在没有告知的情况下，有可能变更或改进，如有需求请咨询我司。

JYH HSU (JEC) ELECTRONICS LTD.,

EIA TEMPERATURE CHARACTERISTIC CHART

First Digit is low Temperature	Second Digit is High Temperature	Last Digit is Capacitance Change Over Temperature Range From +25 °C Reading	
X: -55°C Y: -25°C Z: +10°C	4: +65°C 5: +85°C 6: +105°C 7: +125°C 8: +150°C	A B C D E F P R S T U V	± 1.0 % ± 1.5 % ± 2.2 % ± 3.3 % ± 4.7 % ± 7.5 % ± 10 % ± 15 % ± 22 % + 22 % - 33 % + 22 % - 56 % + 22 % - 82 %

Capacitance Temperature Characteristics

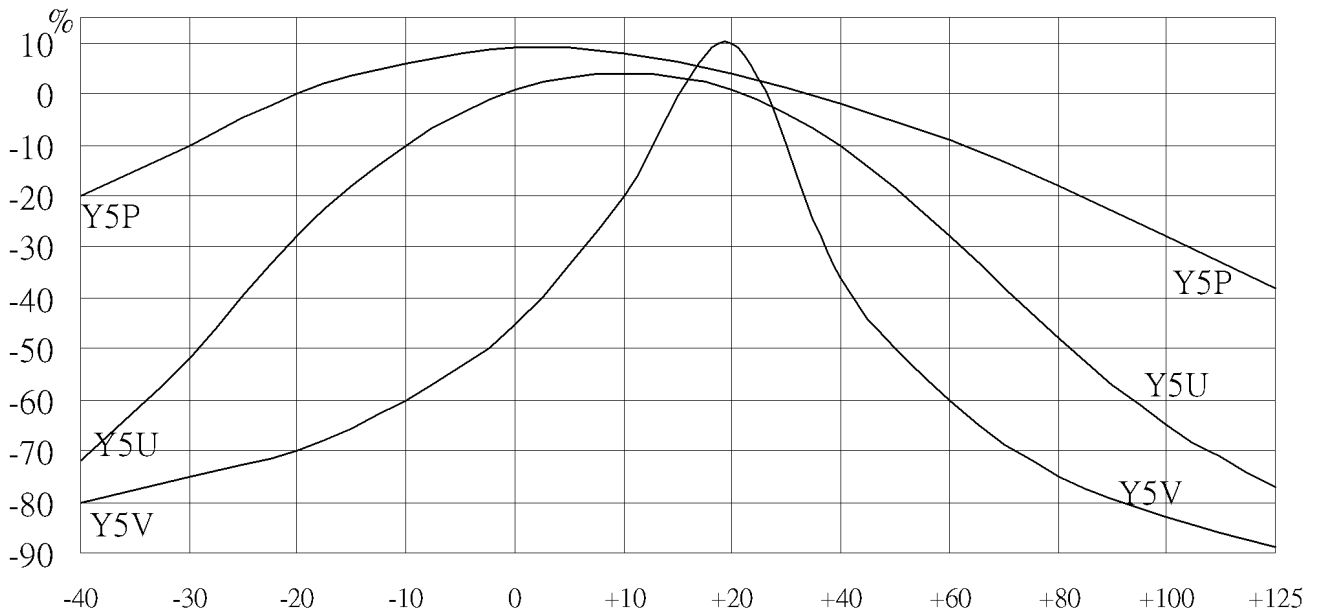

JYH HSU (JEC) ELECTRONICS LTD.,

"Note: (1) Is was defined according with IEC 60384-14:2005, when for qualification approval and periodic tests, the withstanding test must last to 1 minute, and it belong to destroyed test domain, therefore, after the test, capacitors should be scrap. Withstand voltage test should rise slowly at 150V/s, and test time is counted from when the voltage reaches to experiment requirement." (2)

The test time is more than 1 second at production period, and the rated test voltage is applied.

Capacitors may cause to damage when withstand voltage test repeated."

NO.	Item	Characteristic	Test Method	
1	Appearance and Dimensions	Please refer to figures and tables on page 2, 3 and 4.	1~1 1~2	"Production line visual inspection must be done in full and remove the defective products." "Dimensions measurement by micrometer and Caliper
2	Marks	Must be clean and clear.	2~1	Label need to be able endure wiping with Isopropanol
3	Withstand voltage test (I)	Between terminal	3~1	Rated voltage: 300VAC for Y2, test voltage 2000 VAC or 2600 VAC, time 60s, frequency: 50Hz/60Hz Rated voltage: 400VAC for Y1, test voltage 4000 VAC, Approval and period test: 60s, Lot inspection 100% and time 2s, discharge current must ≤ 50 mA."
		Between terminal and coating.	3~2	Use metal foil test method: use metal foil wrap around the capacitor body, each end extending at least 5mm, and keep 1mm/1kV distance minimum, between metal foil and terminals. for Y2, test voltage 2300VAC; for Y1, test voltage 4000VAC, test time 60s.
4	Withstand voltage test(III) (For safety symbol A2)	(1)Gauze shall not ignite. (2)Capacitors shall not in burned.	4~1	According to IEC 60384-14 and GB/T6346 requirements.
5	Withstand voltage test (IV)(For safety symbol B2)	(3)Elements and coating must not scattered. (4)Terminals can not be moved away from the mounting position than 3mm.	5~1	According to IEC 60384-14 and GB/T6346 requirements.
6	I	Between terminals	6~1	Measured voltage is 100 ± 15 V within 1 minute, and IR keeps within the specified value.
	R	Between terminals and coating.		
7	Capacitance	Within specified tolerance	7~1	The Capacitance shall be measured at 25°C, with 1 ± 0.1 kHz and 5Vrms max
8	Dissipation Factor(D.F)	B(Y5P) $\tan \leq 2.5\%$ E(Y5U) $\tan \leq 2.5\%$ F(Y5V) $\tan \leq 5.0\%$	8~1	"The Dissipation Factor shall be measured at 25°C with 1 ± 0.1 kHz and 5Vrms max

NO	Item	Characteristic	Test Method
----	------	----------------	-------------

JYH HSU (JEC) ELECTRONICS LTD.,

9	Temperature Characteristic	Temperature Coefficient (T.C. category applicable):		9~1	Temperature Coefficient (T.C. category applicable):		
		TYPE Temp.Range	SL	YN	9~2	$\text{PPM}/^{\circ}\text{C} = (\text{Ct2} - \text{Ct1}) / \text{Ct1} * (\text{t2} - \text{t1})$ <p>Ct2: the capacitance of t2 Ct1: the capacitance of t1 t2: 85°C±3°C t1: 20°C±2°C</p>	
		20~85°C	+ 350~ -1000pp m°C	- 800~ -5800 ppm°C	9~3		
		Temperature characteristics: (High Dielectric applicable) Capacitance change rate within the range: Type B Within ±10% Type E Within +22% -56% Type F Within +30% -85%				9~3	Temperature phase 1) 20±2°C → 2) -25±2°C → 3) 20±2°C → 4) 85±2°C → 5) 20±2°C Capacitance change: (High Dielectric Category applicable) $C.C(\%) = (\text{CtX} - \text{Ct20}) / \text{Ct20} * 100$ Ctx : Except Temp. phase 1、3、5, The capacitance of any temperature between phase 2 to phase 4. Ct20: The capacitance of phase 3 temp.
10	Robustness of terminations	Tensile	Lead wires not be snapped	10~1	Diameter(mm)	Load(kgs)	Time(sec)
			Capacitors not be damaged	0.5Φ	0.5	10	
				0.6Φ~0.8Φ	1	10	
				10~2	Fix the capacitor's body and apply a tensile weight gradually to each lead wire in the radial direction		
		Bending	Lead wires not be fractured Capacitors not be damaged	10~3	Diameter(mm)	Load(kgs)	Bending angle is 90 more than twice.
				0.5Φ	0.25		
0.6Φ~0.8Φ	0.5						
11	Vibrationresistance	Appearance	No significant abnormal	11~1	Vibration frequency from 10Hz to 55Hz and back to 10Hz, amplitude 1.5mm, period time within 1 minute.		
		Cap. Change	Within specification				
		Q or DF	within initial specification				
12	Soldering Heat Resistance	Appearance	No significant abnormal	12~1	Solder temperature 350±10°C		
		Dielectric Strength I	compliance with the characteristic as No.3	12~2	Immersion time 3.0± 0.5sec		
		Capacitance change rate	B: within ±10% E: within ±15% F: within ±20%	12~3	Placed at room condition for 4~24 hours, and then to measure.		
No	Item	Characteristic		Test Method			

JYH HSU (JEC) ELECTRONICS LTD.,

13	Solder ability	The round surface of lead wires, there must be 3/4 area welding with the solder.。		13~1 13~2	Solder temperature 275±10℃ Immersion time 2.0± 0.5sec
14	Humidity (Under Steady State)	Appearance	No significant abnormal	14~1	Temperature: 40±2℃
Dielectric Strength I		Must meet the requirements of No.3	14~2	Humidity: 90~95%RH	
I R		Between terminals	More than the 1/2 value of No.6 requirements.	14~3	Time: 500±12 Hrs
		Between terminal & coating		14~4	Remove & placed at room condition for 1~2 hours, and then to measure.
Capacitance change rate		Type B within ±15% Type E within ±20% Type F within ±30%			
Dissipation Factor (D.F)		Type B & E, under 5%. Type F, under 7.5%			
15	Damp heat loading	Appearance	No significant abnormal	15~1	Temperature: 40±2℃
Dielectric Strength I		Must meet the requirements of No.3	15~2	Humidity: 90~95%RH	
I R		Between terminals	More than the 1/2 value of No.6 requirements.	15~3	Time: 500±12 Hrs
		Between terminal & coating		15~4	Voltage: AC 180Vrms
Capacitance change rate		Type B within ±15% Type E within ±20% Type F within ±30%	15~5	Current: Less than 50mA	
Dissipation Factor (D.F)		Type B & E, under 5% Type F, under 7.5%.	15~6	Remove & placed at room condition for 1~2 hours, and then to measure.	

JYH HSU (JEC) ELECTRONICS LTD.,

No	Item	Characteristic		Test Method		
16	Endurance	Appearance		No significant abnormal	16~1	Temperature: 85±3℃; 125±5℃ Time: 1000±12 Hrs Voltage: rated voltage of 1.7UR Current: less than 50mA Remove & placed at room condition for 1~2 hours, and then to measure.
		Dielectric Strength I		"Must meet the requirements of No.3	16~2	
		I R	Between terminals	More than the 1/2 value of No.6 requirements.	16~3	
			Between terminal&coating		16~4	
		Capacitance change rate		Type B within ±15% Type E within ±20% Type F within ±30%	16~5	
		Dissipation Factor (D.F)		Type B & E, under 5% Type F, under 7.5%		
17	Flame Test		Applicable safety symbols A2, B2.		The capacitor should be subjected to applied flame for 15 sec, and then removed for 15 sec, until 3 cycles are completed. And then continued to flame a minute and never to explode.	
18	Solvent Resistance (Body)		After the test must meet the standards of its electrical properties		The capacitor should be immersed into a isopropyl alcohol for 5±0.5 minutes, then removed and placed for 48 hrs. at room condition before post measurements.	
19	Solvent Resistance (Mark)		Marks should be legible		Use cotton yarn dips isopropyl alcohol, by force 5±0.5 N/1 cm ² , 1 second round trip twice to wipe mark on the body, and run 5 cycles.	

JYH HSU (JEC) ELECTRONICS LTD.,
TAPING SPECIFICATIONS

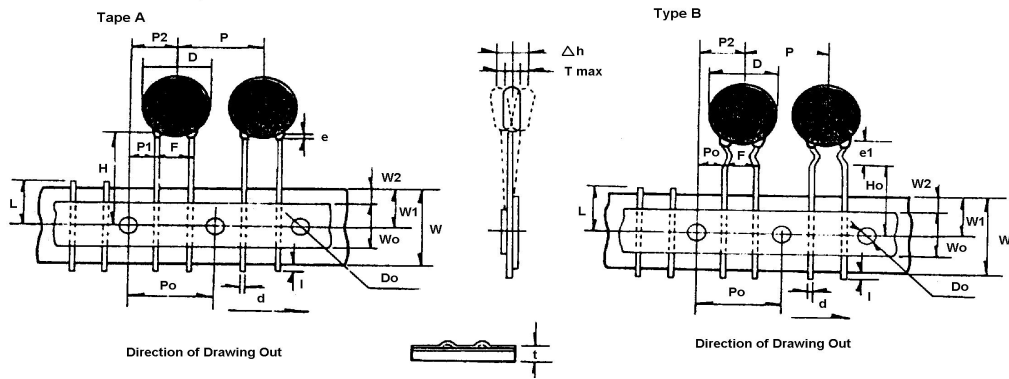

Taping (Radial)--Lead Spacing F= 7.5±0.8 or 10.0±0.8

Item	Code	Dimensions (mm)	Item	Code	Dimensions (mm)	
Taping Pitch	P	12.7/15.0±1.0	Lead Protrusion	l	+0.5~1.0	
Guide Pitch	Po	12.7/15.0±1.0	Diameter of Feed Hole	Do	4.0±0.3	
Lead Spacing	F	5.0±0.8 7.5±0.8 、 9.5±0.8	Diameter of Lead	d	0.55+0.06 -0.05	
Feed Hole Position Capacitor Body	P2	6.35±1.3	Total Thickness of Tape	t	0.7±0.2	
Feed Hole Position Capacitor Lead	P1	3.85±0.7	Thickness of Capacitor Body	T	Differ in each product	
Diameter Of ISO	D	See table of each series	Alignment to FR. Direction	Δ h	0±2.0	
Width Of Base Tape	W	18.0±0.5	Length of snipped Lead	L	11.0 +0 -1.0	
Feed Hole Vertical Position	W1	9.0 +0.75 -0.05	Width of Hold-down Tape	Wo	12.5	
Taping Height	For Straight	Ho	16.0±0.5	Hold-down Tape Position	W2	1.5±1.5
	For Crimp	H	20 +1.5 -1.0	Coating Extention	e	3.0 以下
					e1	up to center of crimp

AMMO PACK

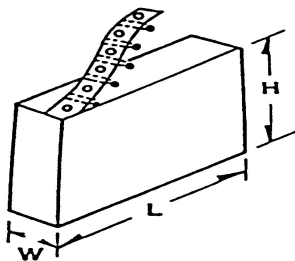

H = 241±5 mm
 L = 332±5 mm
 W = 42±3 mm

Acceptable to standard radial type cartridge.

REE

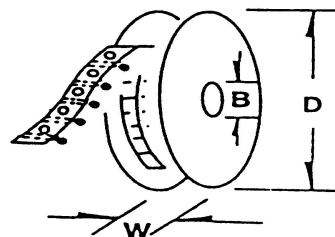

D ≦ 354(13.93)
 B ≦ 21(.83")but
 ≦ 30(1.18")
 W ≦ 55(2.16)

Acceptable to standard radial type cartridge with a few extra accessories. Reeled axials are also acceptable to standard axial type cartridge with a few accessories.