

# Kinghelm®

型号: KH-XH- (2-10) A-W

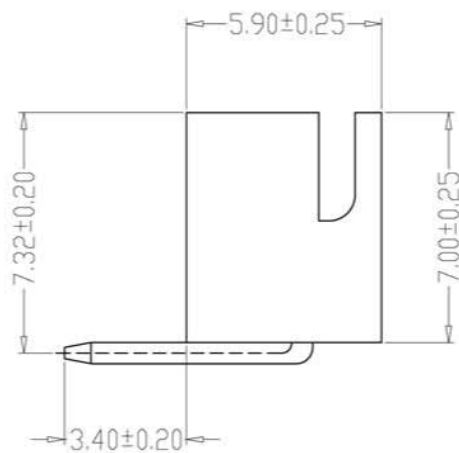

TYPE 1

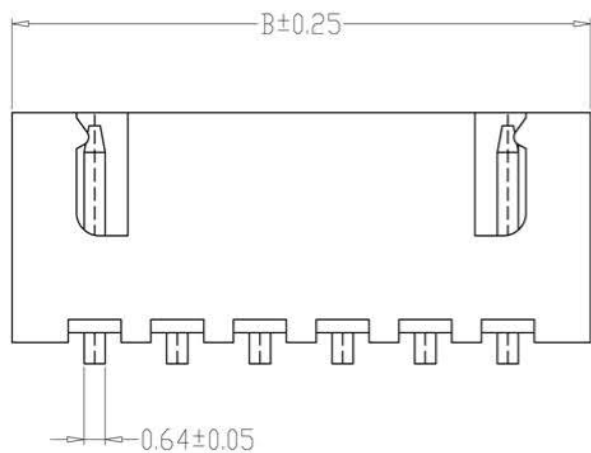
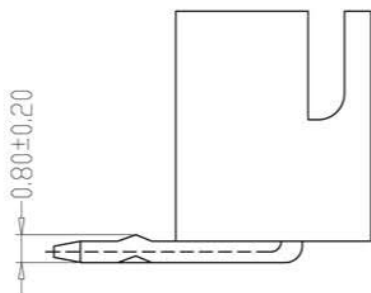
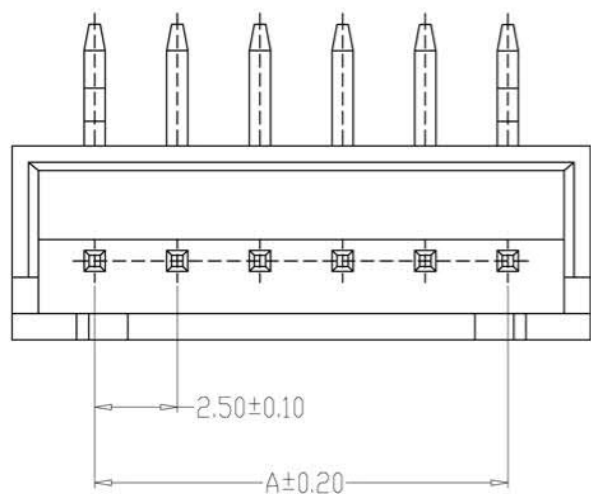

TYPE 2

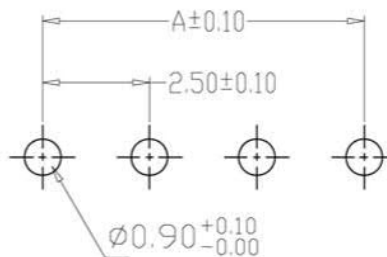

PCB LAYOUT

### SPECIFICATIONS

- 1、Current Rating: 3A AC, DC
- 2、Voltage Rating: 250V AC, DC
- 3、Temperatuer Range:  $-25^{\circ}\text{C} \sim +85^{\circ}\text{C}$
- 4、Contact Resistance:  $20\text{m}\Omega$  Max
- 5、Insulation Resistance:  $1000\text{M}\Omega$  Min
- 6、Withstanding Voltang: 1000V AC/minute
- 7、Material: Wafer Nylon66, UL94V-0  
PIN Brass Tin-plated

编 号	尺寸 (mm)	
	A	B
A2501-02AW	2.50	7.50
A2501-03AW	5.00	10.00
A2501-04AW	7.50	12.50
A2501-05AW	10.00	15.00
A2501-06AW	12.50	17.50
A2501-07AW	15.00	20.00
A2501-08AW	17.50	22.50
A2501-09AW	20.00	25.00
A2501-10AW	22.50	27.50
A2501-11AW	25.00	30.00
A2501-12AW	27.50	32.50
A2501-20AW	47.50	52.50

制图 DRAWN	变更内容 DESCRIPTION	日期 DATE	GENERAL TOLERANCE		制图 DRAWING	钱岳生 2013、07、01	料号 PART NO.	A2501-NAW	版本 REV.	A
			X.±0.25	X.±2'	审核 CHECK	张名 2013、07、03	品名 TITLE	TJC3弯针 WAFER DIP TYPE	页次 SHEET	1/1
			.X±0.20	.X±1'	核准 APPROVAL	张名 2013、07、05	客户料号 CUTM. NO.	型号: KH-XH-8A-W		
			.XX±0.15	.XX±0.5'	单位 UNITS	MM	比例 SCALE	1:1		
			.XXX±0.10	.XXX±0.5'			深圳市金航标电子有限公司	WWW.BDS666.COM	0755-83044319	