

MMBZxxxALT1G Series, SZMMBZxxxALT1G Series

Zener Diodes, 24 and 40 Watt Peak Power

SOT-23 Dual Common Anode Zeners

These dual monolithic silicon Zener diodes are designed for applications requiring transient overvoltage protection capability. They are intended for use in voltage and ESD sensitive equipment such as computers, printers, business machines, communication systems, medical equipment and other applications. Their dual junction common anode design protects two separate lines using only one package. These devices are ideal for situations where board space is at a premium.

Features

- SOT-23 Package Allows Either Two Separate Unidirectional Configurations or a Single Bidirectional Configuration
- Standard Zener Breakdown Voltage Range – 5.6 V to 47 V
- Peak Power – 24 or 40 W @ 1.0 ms (Unidirectional), per Figure 6 Waveform
- ESD Rating:
 - Class 3B (> 16 kV) per the Human Body Model
 - Class C (> 400 V) per the Machine Model
- ESD Rating of IEC61000-4-2 Level 4, ±30 kV Contact Discharge
- Maximum Clamping Voltage @ Peak Pulse Current
- Low Leakage < 5.0 μ A
- Flammability Rating UL 94 V-0
- SZ Prefix for Automotive and Other Applications Requiring Unique Site and Control Change Requirements; AEC-Q101 Qualified and PPAP Capable
- These Devices are Pb-Free and are RoHS Compliant

Mechanical Characteristics

CASE: Void-free, transfer-molded, thermosetting plastic case

FINISH: Corrosion resistant finish, easily solderable

MAXIMUM CASE TEMPERATURE FOR SOLDERING PURPOSES:

260°C for 10 Seconds

Package designed for optimal automated board assembly

Small package size for high density applications

Available in 8 mm Tape and Reel

Use the Device Number to order the 7 inch/3,000 unit reel.

Replace the “T1” with “T3” in the Device Number to order the

13 inch/10,000 unit reel.



ON Semiconductor®

www.onsemi.com



SOT-23
CASE 318
STYLE 12

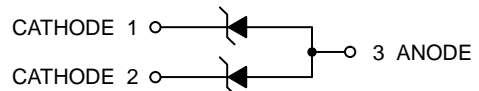

MARKING DIAGRAM



XXX = Specific Device Code

M = Date Code

▪ = Pb-Free Package

(Note: Microdot may be in either location)

ORDERING INFORMATION

See detailed ordering and shipping information on page 2 of this data sheet.

DEVICE MARKING INFORMATION

See specific marking information in the device marking column of the table on page 3 of this data sheet.

MMBZxxxALT1G Series, SZMMBZxxxALT1G Series

MAXIMUM RATINGS

Rating	Symbol	Value	Unit
Peak Power Dissipation @ 1.0 ms (Note 1) @ $T_L \leq 25^\circ\text{C}$	MMBZ5V6ALT1G thru MMBZ9V1ALT1G MMBZ12VALT1G thru MMBZ47VALT1G	P_{pk}	24 40 W
Total Power Dissipation on FR-5 Board (Note 2) @ $T_A = 25^\circ\text{C}$ Derate above 25°C		P_D	225 1.8 mW mW/ $^\circ\text{C}$
Thermal Resistance Junction-to-Ambient		$R_{\theta JA}$	556 $^\circ\text{C/W}$
Total Power Dissipation on Alumina Substrate (Note 3) @ $T_A = 25^\circ\text{C}$ Derate above 25°C		P_D	300 2.4 mW mW/ $^\circ\text{C}$
Thermal Resistance Junction-to-Ambient		$R_{\theta JA}$	417 $^\circ\text{C/W}$
Junction and Storage Temperature Range		T_J, T_{stg}	- 55 to +150 $^\circ\text{C}$
Lead Solder Temperature – Maximum (10 Second Duration)		T_L	260 $^\circ\text{C}$

Stresses exceeding those listed in the Maximum Ratings table may damage the device. If any of these limits are exceeded, device functionality should not be assumed, damage may occur and reliability may be affected.

1. Non-repetitive current pulse per Figure 6 and derate above $T_A = 25^\circ\text{C}$ per Figure 7.
2. FR-5 = 1.0 x 0.75 x 0.62 in.
3. Alumina = 0.4 x 0.3 x 0.024 in, 99.5% alumina.

*Other voltages may be available upon request.

ORDERING INFORMATION

Device	Package	Shipping†
MMBZ5V6ALT1G	SOT-23 (Pb-Free)	3,000 / Tape & Reel
SZMMBZ5V6ALT1G*	SOT-23 (Pb-Free)	3,000 / Tape & Reel
MMBZ5V6ALT3G	SOT-23 (Pb-Free)	10,000 / Tape & Reel
MMBZ6VxALT1G	SOT-23 (Pb-Free)	3,000 / Tape & Reel
SZMMBZ6VxALT1G*	SOT-23 (Pb-Free)	3,000 / Tape & Reel
MMBZ6VxALT3G	SOT-23 (Pb-Free)	10,000 / Tape & Reel
MMBZ9V1ALT1G	SOT-23 (Pb-Free)	3,000 / Tape & Reel
MMBZ9V1ALT13G	SOT-23 (Pb-Free)	10,000 / Tape & Reel
MMBZxxVALT1G	SOT-23 (Pb-Free)	3,000 / Tape & Reel
SZMMBZxxVALT1G*	SOT-23 (Pb-Free)	3,000 / Tape & Reel
MMBZxxVALT3G	SOT-23 (Pb-Free)	10,000 / Tape & Reel
SZMMBZxxVALT3G*	SOT-23 (Pb-Free)	10,000 / Tape & Reel
SZMMBZxxVALT1G*	SOT-23 (Pb-Free)	3,000 / Tape & Reel

†For information on tape and reel specifications, including part orientation and tape sizes, please refer to our Tape and Reel Packaging Specifications Brochure, BRD8011/D.

*SZ Prefix for Automotive and Other Applications Requiring Unique Site and Control Change Requirements; AEC-Q101 Qualified and PPAP Capable

MMBZxxxALT1G Series, SZMMBZxxxALT1G Series

ELECTRICAL CHARACTERISTICS

(T_A = 25°C unless otherwise noted)

UNIDIRECTIONAL (Circuit tied to Pins 1 and 3 or 2 and 3)

Symbol	Parameter
I _{PP}	Maximum Reverse Peak Pulse Current
V _C	Clamping Voltage @ I _{PP}
V _{RWM}	Working Peak Reverse Voltage
I _R	Maximum Reverse Leakage Current @ V _{RWM}
V _{BR}	Breakdown Voltage @ I _T
I _T	Test Current
ΘV _{BR}	Maximum Temperature Coefficient of V _{BR}
I _F	Forward Current
V _F	Forward Voltage @ I _F
Z _{ZT}	Maximum Zener Impedance @ I _{ZT}
I _{ZK}	Reverse Current
Z _{ZK}	Maximum Zener Impedance @ I _{ZK}



ELECTRICAL CHARACTERISTICS (T_A = 25°C unless otherwise noted)

UNIDIRECTIONAL (Circuit tied to Pins 1 and 3 or Pins 2 and 3)

(V_F = 0.9 V Max @ I_F = 10 mA) (5% Tolerance)

24 WATTS

Device*	Device Marking	V _{RWM} Volts	I _R @ V _{RWM} μA	Breakdown Voltage				Max Zener Impedance (Note 5)			V _C @ I _{PP} (Note 6)		ΘV _{BR} mV/°C
				V _{BR} (Note 4) (V)			@ I _T	Z _{ZT} @ I _{ZT}	Z _{ZK} @ I _{ZK}	V _C	I _{PP}		
				Min	Nom	Max	mA	Ω	Ω	mA	V	A	
MMBZ5V6ALT1G/T3G	5A6	3.0	5.0	5.32	5.6	5.88	20	11	1600	0.25	8.0	3.0	1.26
MMBZ6V2ALT1G	6A2	3.0	0.5	5.89	6.2	6.51	1.0	-	-	-	8.7	2.76	2.80
MMBZ6V8ALT1G	6A8	4.5	0.5	6.46	6.8	7.14	1.0	-	-	-	9.6	2.5	3.4
MMBZ9V1ALT1G	9A1	6.0	0.3	8.65	9.1	9.56	1.0	-	-	-	14	1.7	7.5

(V_F = 0.9 V Max @ I_F = 10 mA) (5% Tolerance)

40 WATTS

Device*	Device Marking	V _{RWM} Volts	I _R @ V _{RWM} nA	Breakdown Voltage				V _C @ I _{PP} (Note 6)		ΘV _{BR} mV/°C
				V _{BR} (Note 4) (V)			@ I _T	V _C	I _{PP}	
				Min	Nom	Max	mA	V	A	
MMBZ12VALT1G	12A	8.5	200	11.40	12	12.60	1.0	17	2.35	7.5
MMBZ15VALT1G	15A	12	50	14.25	15	15.75	1.0	21	1.9	12.3
MMBZ16VALT1G	16A	13	50	15.20	16	16.80	1.0	23	1.7	13.8
MMBZ18VALT1G	18A	14.5	50	17.10	18	18.90	1.0	25	1.6	15.3
MMBZ20VALT1G	20A	17	50	19.00	20	21.00	1.0	28	1.4	17.2
MMBZ27VALT1G/T3G	27A	22	50	25.65	27	28.35	1.0	40	1.0	24.3
MMBZ33VALT1G	33A	26	50	31.35	33	34.65	1.0	46	0.87	30.4
MMBZ47VALT1G	47A	38	50	44.65	47	49.35	1.0	54	0.74	43.1

(V_F = 0.9 V Max @ I_F = 10 mA) (2% Tolerance)

40 WATTS

Device*	Device Marking	V _{RWM} Volts	I _R @ V _{RWM} nA	Breakdown Voltage				V _C @ I _{PP} (Note 6)		ΘV _{BR} mV/°C
				V _{BR} (Note 4) (V)			@ I _T	V _C	I _{PP}	
				Min	Nom	Max	mA	V	A	
MMBZ16VTALT1G	16T	13	50	15.68	16	16.32	1.0	23	1.7	13.8
MMBZ47VTALT1G	47T	38	50	46.06	47	47.94	1.0	54	0.74	43.1

Product parametric performance is indicated in the Electrical Characteristics for the listed test conditions, unless otherwise noted. Product performance may not be indicated by the Electrical Characteristics if operated under different conditions.

4. V_{BR} measured at pulse test current I_T at an ambient temperature of 25°C.

5. Z_{ZT} and Z_{ZK} are measured by dividing the AC voltage drop across the device by the AC current applied. The specified limits are for I_{Z(AC)} = 0.1 I_{Z(DC)}, with the AC frequency = 1.0 kHz.

6. Surge current waveform per Figure 6 and derate per Figure 7

* Include SZ-prefix devices where applicable.

MMBZxxxALT1G Series, SZMMBZxxxALT1G Series

TYPICAL CHARACTERISTICS

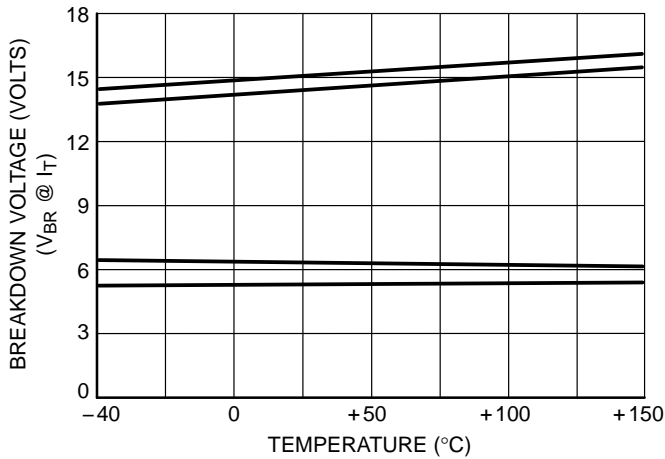

Figure 1. Typical Breakdown Voltage versus Temperature

(Upper curve for each voltage is bidirectional mode, lower curve is unidirectional mode)

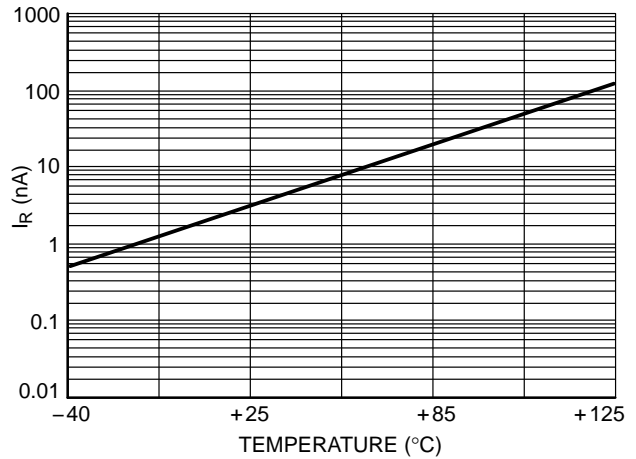

Figure 2. Typical Leakage Current versus Temperature



Figure 3. Typical Capacitance versus Bias Voltage

(Upper curve for each voltage is unidirectional mode, lower curve is bidirectional mode)

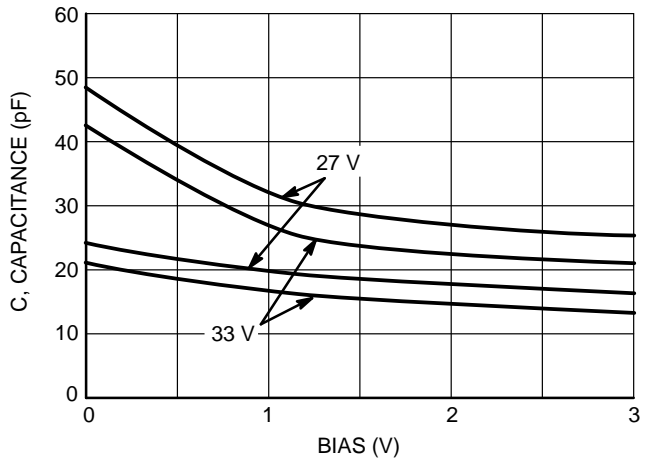

Figure 4. Typical Capacitance versus Bias Voltage

(Upper curve for each voltage is unidirectional mode, lower curve is bidirectional mode)

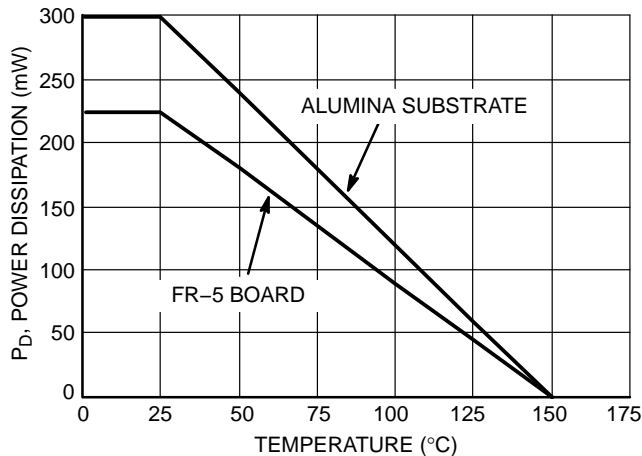

Figure 5. Steady State Power Derating Curve

MMBZxxxALT1G Series, SZMMBZxxxALT1G Series

TYPICAL CHARACTERISTICS

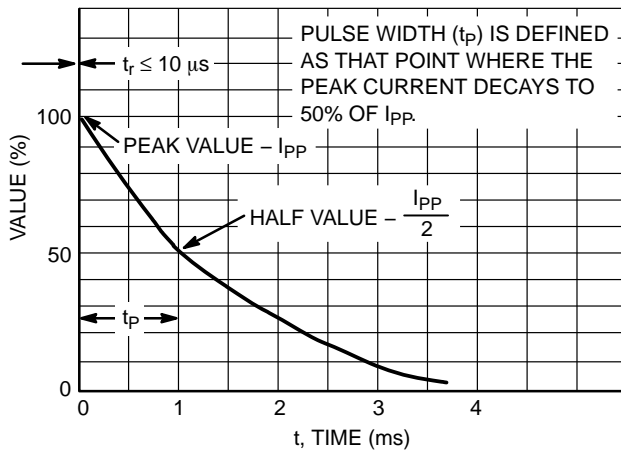

Figure 6. Pulse Waveform

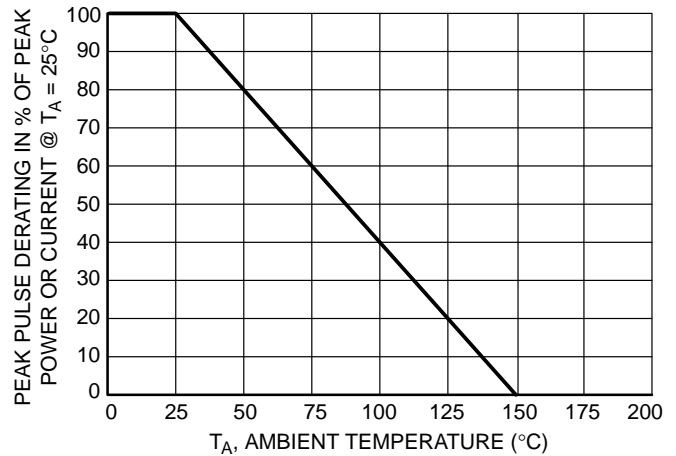

Figure 7. Pulse Derating Curve



Figure 8. Maximum Non-repetitive Surge Power, P_{pk} versus PW

Power is defined as $V_{RSM} \times I_{Z(pk)}$ where V_{RSM} is the clamping voltage at $I_{Z(pk)}$.

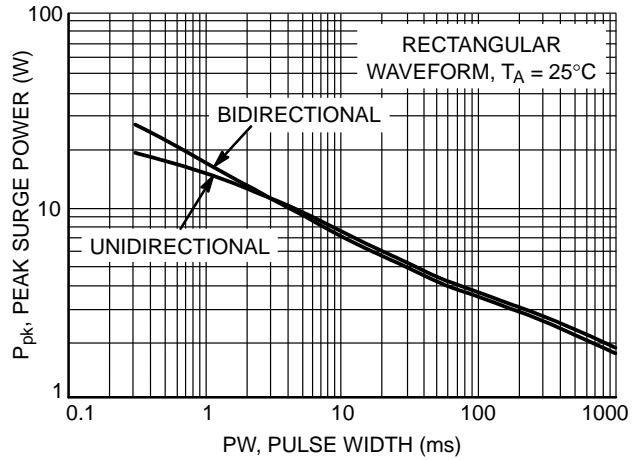

Figure 9. Maximum Non-repetitive Surge Power, $P_{pk(NOM)}$ versus PW

Power is defined as $V_Z(NOM) \times I_{Z(pk)}$ where $V_Z(NOM)$ is the nominal Zener voltage measured at the low test current used for voltage classification.

MMBZxxxALT1G Series, SZMMBZxxxALT1G Series

TYPICAL COMMON ANODE APPLICATIONS

A dual junction common anode design in a SOT-23 package protects two separate lines using only one package. This adds flexibility and creativity to PCB design especially

when board space is at a premium. Two simplified examples of ESD applications are illustrated below.

Computer Interface Protection



Microprocessor Protection

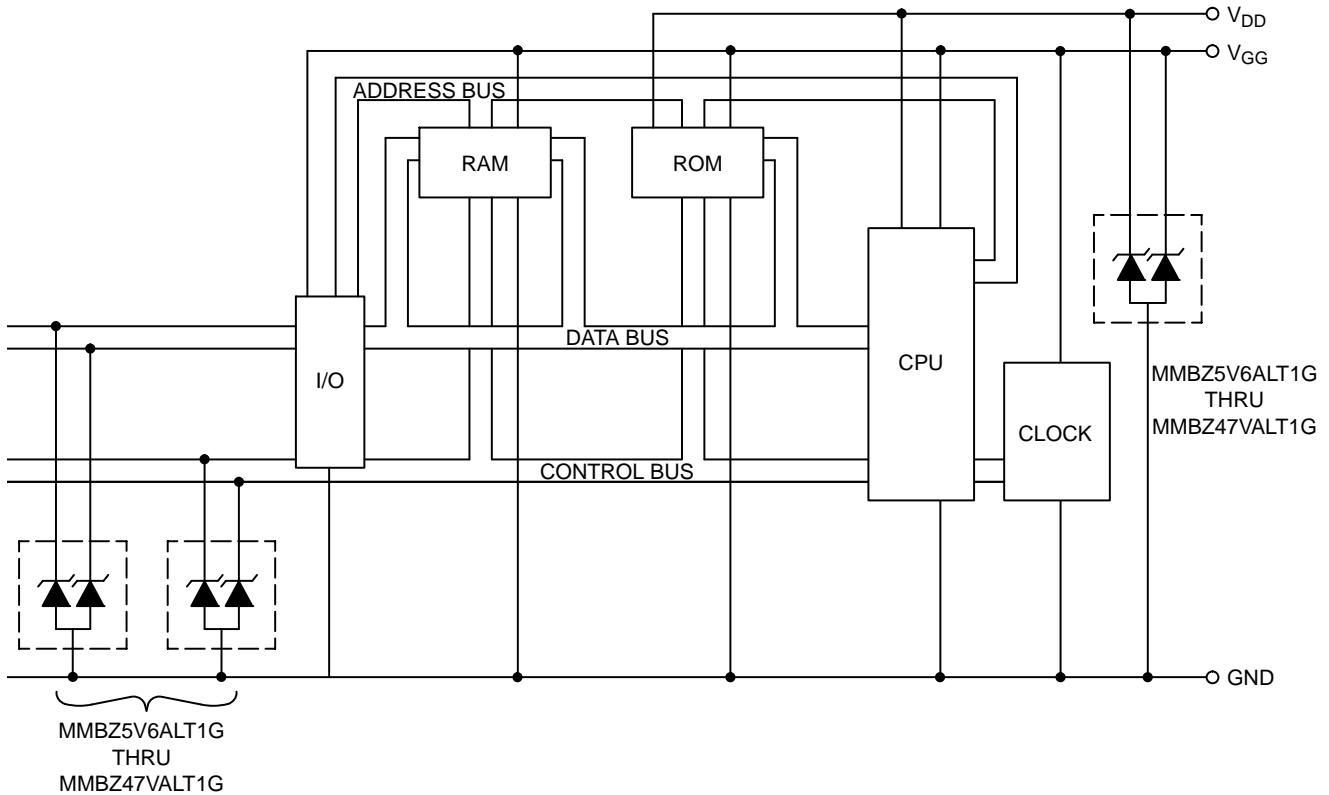

MECHANICAL CASE OUTLINE

PACKAGE DIMENSIONS

ON Semiconductor®



SOT-23 (TO-236)
CASE 318-08
ISSUE AS

DATE 30 JAN 2018

SCALE 4:1



NOTES:

1. DIMENSIONING AND TOLERANCING PER ASME Y14.5M, 1994.
2. CONTROLLING DIMENSION: MILLIMETERS.
3. MAXIMUM LEAD THICKNESS INCLUDES LEAD FINISH. MINIMUM LEAD THICKNESS IS THE MINIMUM THICKNESS OF THE BASE MATERIAL.
4. DIMENSIONS D AND E DO NOT INCLUDE MOLD FLASH, PROTRUSIONS, OR GATE BURRS.

DIM	MILLIMETERS			INCHES		
	MIN	NOM	MAX	MIN	NOM	MAX
A	0.89	1.00	1.11	0.035	0.039	0.044
A1	0.01	0.06	0.10	0.000	0.002	0.004
b	0.37	0.44	0.50	0.015	0.017	0.020
c	0.08	0.14	0.20	0.003	0.006	0.008
D	2.80	2.90	3.04	0.110	0.114	0.120
E	1.20	1.30	1.40	0.047	0.051	0.055
e	1.78	1.90	2.04	0.070	0.075	0.080
L	0.30	0.43	0.55	0.012	0.017	0.022
L1	0.35	0.54	0.69	0.014	0.021	0.027
HE	2.10	2.40	2.64	0.083	0.094	0.104
T	0°	---	10°	0°	---	10°

RECOMMENDED SOLDERING FOOTPRINT



GENERIC MARKING DIAGRAM*



XXX = Specific Device Code
M = Date Code
▪ = Pb-Free Package

*This information is generic. Please refer to device data sheet for actual part marking. Pb-Free indicator, "G" or microdot "▪", may or may not be present.

- | | | | |
|---|---|---|--|
| STYLE 1 THRU 5:
CANCELLED | STYLE 6:
PIN 1. BASE
2. EMITTER
3. COLLECTOR | STYLE 7:
PIN 1. EMITTER
2. BASE
3. COLLECTOR | STYLE 8:
PIN 1. ANODE
2. NO CONNECTION
3. CATHODE |
| STYLE 9:
PIN 1. ANODE
2. ANODE
3. CATHODE | STYLE 10:
PIN 1. DRAIN
2. SOURCE
3. GATE | STYLE 11:
PIN 1. ANODE
2. CATHODE
3. CATHODE-ANODE | STYLE 12:
PIN 1. CATHODE
2. CATHODE
3. ANODE |
| STYLE 13:
PIN 1. SOURCE
2. DRAIN
3. GATE | STYLE 14:
PIN 1. CATHODE
2. GATE
3. ANODE | STYLE 15:
PIN 1. GATE
2. CATHODE
3. ANODE | STYLE 16:
PIN 1. ANODE
2. CATHODE
3. CATHODE |
| STYLE 17:
PIN 1. NO CONNECTION
2. ANODE
3. CATHODE | STYLE 18:
PIN 1. NO CONNECTION
2. CATHODE
3. ANODE | STYLE 19:
PIN 1. CATHODE
2. ANODE
3. CATHODE-ANODE | STYLE 20:
PIN 1. CATHODE
2. ANODE
3. GATE |
| STYLE 21:
PIN 1. GATE
2. SOURCE
3. DRAIN | STYLE 22:
PIN 1. RETURN
2. OUTPUT
3. INPUT | STYLE 23:
PIN 1. ANODE
2. ANODE
3. CATHODE | STYLE 24:
PIN 1. GATE
2. DRAIN
3. SOURCE |
| STYLE 25:
PIN 1. ANODE
2. CATHODE
3. GATE | STYLE 26:
PIN 1. CATHODE
2. ANODE
3. NO CONNECTION | STYLE 27:
PIN 1. CATHODE
2. CATHODE
3. CATHODE | STYLE 28:
PIN 1. ANODE
2. ANODE
3. ANODE |

DOCUMENT NUMBER:	98ASB42226B	Electronic versions are uncontrolled except when accessed directly from the Document Repository. Printed versions are uncontrolled except when stamped "CONTROLLED COPY" in red.
DESCRIPTION:	SOT-23 (TO-236)	PAGE 1 OF 1

ON Semiconductor and ON are trademarks of Semiconductor Components Industries, LLC dba ON Semiconductor or its subsidiaries in the United States and/or other countries. ON Semiconductor reserves the right to make changes without further notice to any products herein. ON Semiconductor makes no warranty, representation or guarantee regarding the suitability of its products for any particular purpose, nor does ON Semiconductor assume any liability arising out of the application or use of any product or circuit, and specifically disclaims any and all liability, including without limitation special, consequential or incidental damages. ON Semiconductor does not convey any license under its patent rights nor the rights of others.

ON Semiconductor and  are trademarks of Semiconductor Components Industries, LLC dba ON Semiconductor or its subsidiaries in the United States and/or other countries. ON Semiconductor owns the rights to a number of patents, trademarks, copyrights, trade secrets, and other intellectual property. A listing of ON Semiconductor's product/patent coverage may be accessed at www.onsemi.com/site/pdf/Patent-Marking.pdf. ON Semiconductor reserves the right to make changes without further notice to any products herein. ON Semiconductor makes no warranty, representation or guarantee regarding the suitability of its products for any particular purpose, nor does ON Semiconductor assume any liability arising out of the application or use of any product or circuit, and specifically disclaims any and all liability, including without limitation special, consequential or incidental damages. Buyer is responsible for its products and applications using ON Semiconductor products, including compliance with all laws, regulations and safety requirements or standards, regardless of any support or applications information provided by ON Semiconductor. "Typical" parameters which may be provided in ON Semiconductor data sheets and/or specifications can and do vary in different applications and actual performance may vary over time. All operating parameters, including "Typicals" must be validated for each customer application by customer's technical experts. ON Semiconductor does not convey any license under its patent rights nor the rights of others. ON Semiconductor products are not designed, intended, or authorized for use as a critical component in life support systems or any FDA Class 3 medical devices or medical devices with a same or similar classification in a foreign jurisdiction or any devices intended for implantation in the human body. Should Buyer purchase or use ON Semiconductor products for any such unintended or unauthorized application, Buyer shall indemnify and hold ON Semiconductor and its officers, employees, subsidiaries, affiliates, and distributors harmless against all claims, costs, damages, and expenses, and reasonable attorney fees arising out of, directly or indirectly, any claim of personal injury or death associated with such unintended or unauthorized use, even if such claim alleges that ON Semiconductor was negligent regarding the design or manufacture of the part. ON Semiconductor is an Equal Opportunity/Affirmative Action Employer. This literature is subject to all applicable copyright laws and is not for resale in any manner.

PUBLICATION ORDERING INFORMATION

LITERATURE FULFILLMENT:

Email Requests to: orderlit@onsemi.com

ON Semiconductor Website: www.onsemi.com

TECHNICAL SUPPORT

North American Technical Support:
Voice Mail: 1 800-282-9855 Toll Free USA/Canada
Phone: 011 421 33 790 2910

Europe, Middle East and Africa Technical Support:

Phone: 00421 33 790 2910

For additional information, please contact your local Sales Representative