



## 600 Watt Surface Mount Transient Voltage Suppressor

Screening in  
reference to  
MIL-PRF-19500  
available

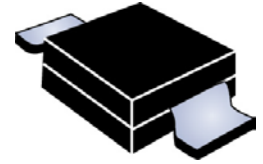
### DESCRIPTION

The MSMB 5.0A – MSMB 170CA series of surface mount 600 watt transient voltage suppressors provide a selection of standoff voltages ( $V_{wm}$ ) from 5.0 to 170 V. These high-reliability devices are available in either unidirectional or bidirectional versions. The SMBG Gull-wing design in the DO-215AA package is ideal for visible solder connections. The SMBJ J-bend design in the DO-214AA package allows for greater PC board mounting density. It is available with SnPb or RoHS compliant matte-tin plating.

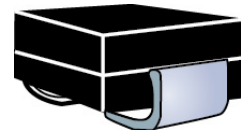
**Important:** For the latest information, visit our website <http://www.microsemi.com>.

### FEATURES

- High reliability devices with wafer fabrication and assembly lot traceability.
- All devices 100% surge tested.
- Enhanced reliability screening in reference to MIL-PRF-19500 is also available. Refer to [High Reliability Up-Screened Plastic Products Portfolio](#) for more details on the screening options.  
(See [part nomenclature](#) for all options.)
- Moisture classification is Level 1 with no dry pack required per IPC/JEDEC J-STD-020B.
- 3 $\sigma$  lot norm screening performed on standby current ( $I_D$ ).
- RoHS compliant versions available.



**DO-215AA  
Gull-wing Package**



**DO-214AA  
J-bend Package**


**NOTE:** All SMB series are equivalent to prior SMS package identifications.

### APPLICATIONS / BENEFITS

- Protects sensitive components such as IC's, CMOS, Bipolar, BiCMOS, ECL, DTL, T2L, etc.
- Protection from switching transients & RF induced voltage pulses.
- Protection from ESD and EFT per IEC 61000-4-2 and IEC 61000-4-4.
- Secondary lightning protection per IEC61000-4-5 with 42 ohms source impedance:
  - Class 1: MSB 5.0A to MSMB 120CA
  - Class 2: MSMB 5.0A to MSMB 60CA
  - Class 3: MSMB 5.0A to MSMB 30CA
  - Class 4: MSMB 5.0A to MSMB 15CA
- Secondary lightning protection per IEC61000-4-5 with 12 ohms source impedance:
  - Class 1: MSMB 5.0A to MSMB 36CA
  - Class 2: MSMB 5.0A to MSMB 18CA

Also available in:

 **Commercial Grade**  
[SMBJ5.0A – SMBJ170CAe3](#)

 **T-18 package**  
(axial-leaded)  
[P6KE6.8A – P6KE200CAe3](#)

### MAXIMUM RATINGS @ 25 °C unless otherwise stated

Parameters/Test Conditions	Symbol	Value	Unit
Junction and Storage Temperature	$T_J$ and $T_{STG}$	-65 to +150	°C
Thermal Resistance, Junction to Lead	$R_{\theta JL}$	25	°C/W
Thermal Resistance, Junction to Ambient <sup>(1)</sup>	$R_{\theta JA}$	90	°C/W
Peak Pulse Power Dissipation <sup>(2)</sup>	$P_{PP}$	600	W
Rated Average Power Dissipation <sup>(1)</sup>	$P_{M(AV)}$	@ $T_L \leq 25$ °C	5
		@ $T_A = 25$ °C	1.38
$T_{clamping}$ (0 volts to $V_{(BR)}$ min)	Unidirectional Bidirectional	< 100	ps
		< 5	ns
Forward Surge Current <sup>(3)</sup>	$I_{FS}$	100	A (pk)
Solder Temperature @ 10 s	$T_{SP}$	260	°C

- Notes:**
1. When mounted on FR4 PC board (1oz Cu) with recommended footprint (see [pad layout](#) on last page).
  2. With impulse repetition rate (duty factor) of 0.01 % or less (also [Figure 1 and 4](#)).
  3. Peak impulse of 8.3 ms half-sine wave (unidirectional only).

#### MSC – Lawrence

6 Lake Street,  
Lawrence, MA 01841  
Tel: 1-800-446-1158 or  
(978) 620-2600  
Fax: (978) 689-0803

#### MSC – Ireland

Gort Road Business Park,  
Ennis, Co. Clare, Ireland  
Tel: +353 (0) 65 6840044  
Fax: +353 (0) 65 6822298

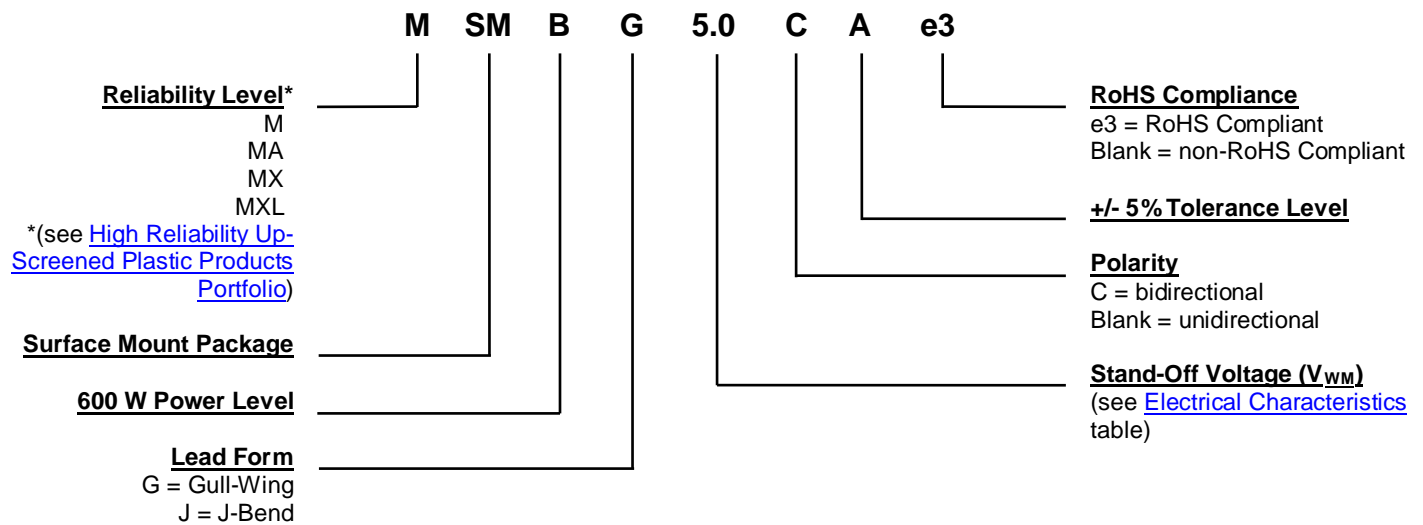
#### Website:

[www.microsemi.com](http://www.microsemi.com)

### MECHANICAL and PACKAGING

- CASE: Void-free transfer molded thermosetting epoxy body meeting UL94V-0 requirements.
- TERMINALS: Tin-lead or RoHS compliant annealed matte-tin plating readily solderable per MIL-STD-750, method 2026.
- MARKING: Part number.
- POLARITY: Cathode end banded.
- TAPE & REEL option: Standard per EIA-481-1-A (add "TR" suffix to part number). Consult factory for quantities.
- WEIGHT: Approximately 0.1 grams.
- See [Package Dimensions](#) on last page.

### PART NOMENCLATURE



### SYMBOLS & DEFINITIONS

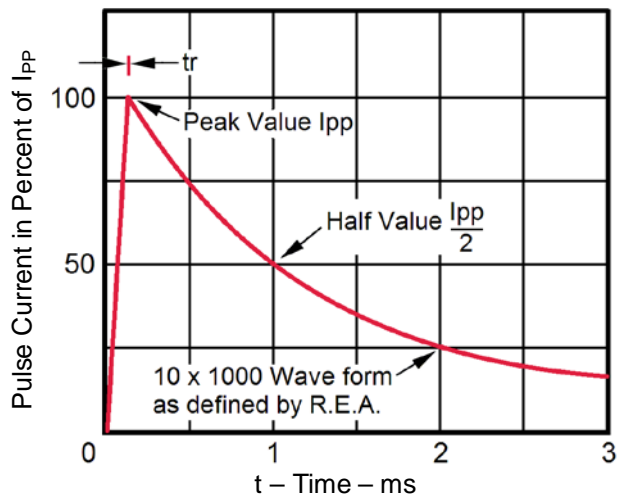
Symbol	Definition
$V_{WM}$	Working Peak (Standoff) Voltage - The maximum peak voltage that can be applied over the operating temperature range. This is also referred to as standoff voltage.
$P_{PP}$	Peak Pulse Power - Rated random recurring peak impulse power dissipation.
$V_{(BR)}$	Breakdown Voltage - The minimum voltage the device will exhibit at a specified current.
$I_D$	Standby Current - The current at the rated standoff voltage ( $V_{WM}$ ).
$I_{PP}$	Peak Pulse Current - The peak current during the impulse.
$V_C$	Clamping Voltage - Clamping voltage at $I_{PP}$ (peak pulse current) at the specified pulse conditions (typically shown as maximum value).
$I_{BR}$	Breakdown Current – The current used for measuring breakdown voltage $V_{(BR)}$ .

**ELECTRICAL CHARACTERISTICS @ 25 °C**

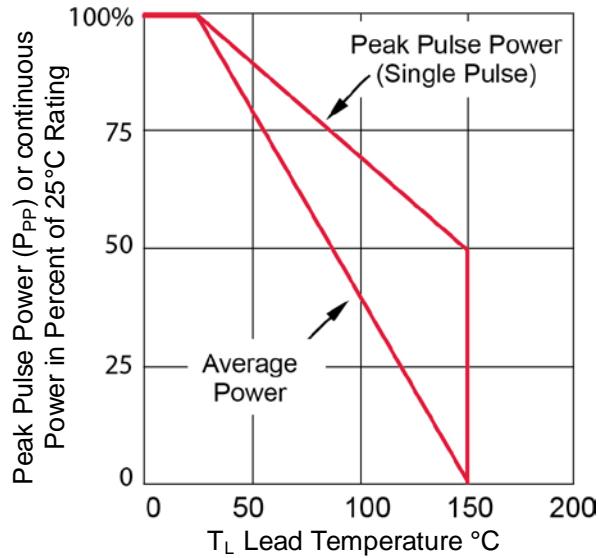
PART NUMBER		REVERSE STAND-OFF VOLTAGE V <sub>WM</sub>	BREAKDOWN VOLTAGE		MAXIMUM CLAMPING VOLTAGE V <sub>C</sub> @ I <sub>PP</sub>	PEAK PULSE CURRENT (see Fig. 2) I <sub>PP</sub>	MAXIMUM STANDBY CURRENT I <sub>D</sub> @ V <sub>WM</sub>
Gull-Wing	J-Bend	V	V (BR)	@ I (BR)	V	A	µA
MSMBG5.0A	MSMBJ5.0A	5	6.40 – 7.00	10	9.2	65.2	800
MSMBG6.0A	MSMBJ6.0A	6	6.67 – 7.37	10	10.3	58.3	800
MSMBG6.5A	MSMBJ6.5A	6.5	7.22 – 7.98	10	11.2	53.6	500
MSMBG7.0A	MSMBJ7.0A	7	7.78 – 8.60	10	12	50	200
MSMBG7.5A	MSMBJ7.5A	7.5	8.33 – 9.21	1	12.9	46.5	100
MSMBG8.0A	MSMBJ8.0A	8	8.89 – 9.83	1	13.6	44.1	50
MSMBG8.5A	MSMBJ8.5A	8.5	9.44 – 10.4	1	14.4	41.7	10
MSMBG9.0A	MSMBJ9.0A	9	10.0 – 11.1	1	15.4	39	5
MSMBG10A	MSMBJ10A	10	11.1 – 12.3	1	17	35.3	5
MSMBG11A	MSMBJ11A	11	12.2 – 13.5	1	18.2	33	5
MSMBG12A	MSMBJ12A	12	13.3 – 14.7	1	19.9	30.2	5
MSMBG13A	MSMBJ13A	13	14.4 – 15.9	1	21.5	27.9	1
MSMBG14A	MSMBJ14A	14	15.6 – 17.2	1	23.2	25.8	1
MSMBG15A	MSMBJ15A	15	16.7 – 18.5	1	24.4	24	1
MSMBG16A	MSMBJ16A	16	17.8 – 19.7	1	26	23.1	1
MSMBG17A	MSMBJ17A	17	18.9 – 20.9	1	27.6	21.7	1
MSMBG18A	MSMBJ18A	18	20.0 – 22.1	1	29.2	20.5	1
MSMBG20A	MSMBJ20A	20	22.2 – 24.5	1	32.4	18.5	1
MSMBG22A	MSMBJ22A	22	24.4 – 26.9	1	35.5	16.9	1
MSMBG24A	MSMBJ24A	24	26.7 – 29.5	1	38.9	15.4	1
MSMBG26A	MSMBJ26A	26	28.9 – 31.9	1	42.1	14.2	1
MSMBG28A	MSMBJ28A	28	31.1 – 34.4	1	45.4	13.2	1
MSMBG30A	MSMBJ30A	30	33.3 – 36.8	1	48.4	12.4	1
MSMBG33A	MSMBJ33A	33	36.7 – 40.6	1	53.3	11.3	1
MSMBG36A	MSMBJ36A	36	40.0 – 44.2	1	58.1	10.3	1
MSMBG40A	MSMBJ40A	40	44.4 – 49.1	1	64.5	9.3	1
MSMBG43A	MSMBJ43A	43	47.8 – 52.8	1	69.4	8.6	1
MSMBG45A	MSMBJ45A	45	50.0 – 55.3	1	72.7	8.3	1
MSMBG48A	MSMBJ48A	48	53.3 – 58.9	1	77.4	7.7	1
MSMBG51A	MSMBJ51A	51	56.7 – 62.7	1	82.4	7.3	1
MSMBG54A	MSMBJ54A	54	60.0 – 66.3	1	87.1	6.9	1
MSMBG58A	MSMBJ58A	58	64.4 – 71.2	1	93.6	6.4	1
MSMBG60A	MSMBJ60A	60	66.7 – 73.7	1	96.8	6.2	1
MSMBG64A	MSMBJ64A	64	71.1 – 78.6	1	103	5.8	1
MSMBG70A	MSMBJ70A	70	77.8 – 86.0	1	113	5.3	1
MSMBG75A	MSMBJ75A	75	83.3 – 92.1	1	121	4.9	1
MSMBG78A	MSMBJ78A	78	86.7 – 95.8	1	126	4.7	1
MSMBG85A	MSMBJ85A	85	94.4 – 104	1	137	4.4	1
MSMBG90A	MSMBJ90A	90	100 – 111	1	146	4.1	1
MSMBG100A	MSMBJ100A	100	111 – 123	1	162	3.7	1
MSMBG110A	MSMBJ110A	110	122 – 135	1	177	3.4	1
MSMBG120A	MSMBJ120A	120	133 – 147	1	193	3.1	1
MSMBG130A	MSMBJ130A	130	144 – 159	1	209	2.9	1
MSMBG150A	MSMBJ150A	150	167 – 185	1	243	2.5	1
MSMBG160A	MSMBJ160A	160	178 – 197	1	259	2.3	1
MSMBG170A	MSMBJ170A	170	189 – 209	1	275	2.2	1

**GRAPHS**

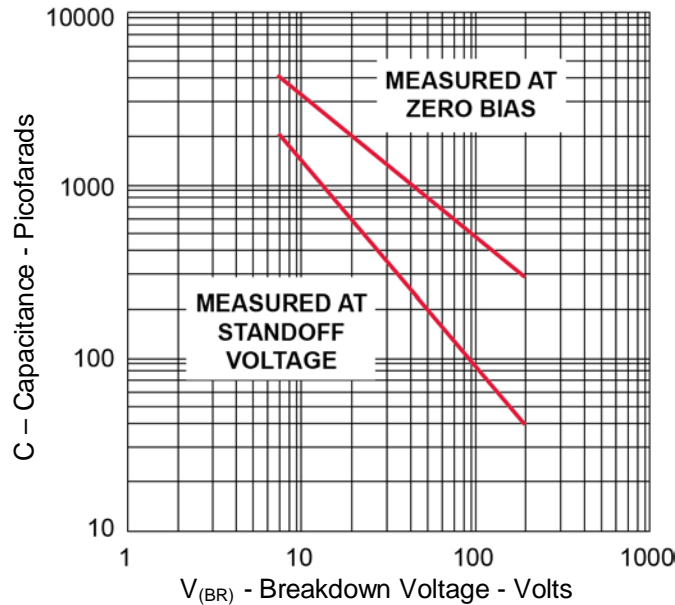

**FIGURE 1**  
Peak Pulse Power vs Pulse Time



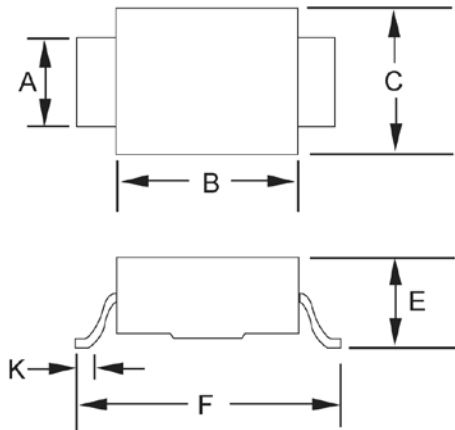
**FIGURE 2**  
Pulse Waveform for 10/1000 Exponential Surge

**GRAPHS (continued)**


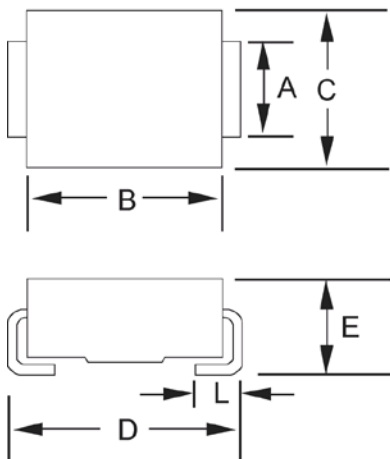
**FIGURE 3**  
Derating Curve



**FIGURE 4**  
Typical Capacitance vs. Breakdown Voltage  
NOTE: Bidirectional capacitance is half that shown at zero volts.

**PACKAGE DIMENSIONS**

**SMBG (DO-215AA)**

Ltr	Dimensions			
	Inch		Millimeters	
	Min	Max	Min	Max
<b>A</b>	.077	.083	1.96	2.10
<b>B</b>	.160	.180	4.06	4.57
<b>C</b>	.130	.155	3.30	3.94
<b>E</b>	.077	.104	1.95	2.65
<b>F</b>	.235	.255	5.97	6.48
<b>K</b>	.015	.030	.381	.762


**SMBJ (DO-214AA)**

Ltr	Dimensions			
	Inch		Millimeters	
	Min	Max	Min	Max
<b>A</b>	.077	.083	1.96	2.10
<b>B</b>	.160	.180	4.06	4.57
<b>C</b>	.130	.155	3.30	3.94
<b>D</b>	.205	.220	5.21	5.59
<b>E</b>	.077	.104	1.95	2.65
<b>L</b>	.030	.060	.760	1.52

See pad layout on next page.

**PAD LAYOUT**


<b>SMBG (DO-215AA)</b>		
<b>Ltr</b>	<b>Inch</b>	<b>Millimeters</b>
<b>A</b>	0.320	8.13
<b>B</b>	0.085	2.16
<b>C</b>	0.110	2.79

<b>SMBJ (DO-214AA)</b>		
<b>Ltr</b>	<b>Inch</b>	<b>Millimeters</b>
<b>A</b>	0.260	6.60
<b>B</b>	0.085	2.16
<b>C</b>	0.110	2.79