

PNP Silicon Plastic-Encapsulate Transistors

(Pb) Lead(Pb)-Free

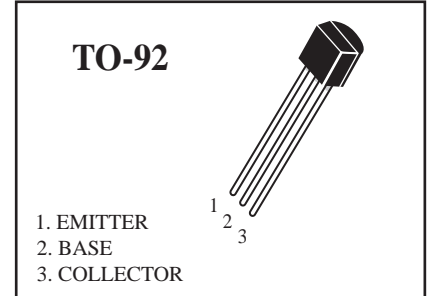
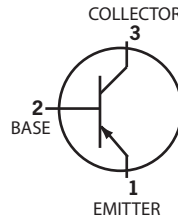

ABSOLUTE MAXIMUM RATINGS (Ta=25°C)

Rating	Symbol	SS8550	Unit
Collector-Emitter Voltage	V _{CEO}	-25	Vdc
Collector-Base Voltage	V _{CBO}	-40	Vdc
Emitter-Base Voltage	V _{EBO}	-5.0	Vdc
Collector Current	I _C	-1.5	Adc
Total Device Dissipation T _A =25°C	P _D	1.0	W
Junction Temperature	T _j	150	°C
Storage Temperature	T _{stg}	-55 to +150	°C

ELECTRICAL CHARACTERISTICS

Characteristics	Symbol	Min	Max	Unit
Collector-Emitter Breakdown Voltage ⁽¹⁾ (I _C = -0.1 mA _{dc} , I _B =0)	V _{(BR)CEO}	-25	-	Vdc
Collector-Base Breakdown Voltage (I _C = -100 uA _{dc} , I _E =0)	V _{(BR)CBO}	-40	-	Vdc
Emitter-Base Breakdown Voltage (I _E = -100 uA _{dc} , I _C =0)	V _{(BR)EBO}	-5.0	-	Vdc
Collector Cutoff Current (V _{CB} = -40 Vdc, I _E =0 Vdc)	I _{CBO}	-	-0.1	uA _{dc}
Emitter Cutoff Current (V _{EB} = -5 Vdc, I _C =0 Vdc)	I _{EBO}	-	-0.1	uA _{dc}

1. Pulse Test: Pulse Width ≤ 300 us, Duty Cycle ≤ 2.0%

ELECTRICAL CHARACTERISTICS ($T_A=25^{\circ}\text{C}$ unless otherwise noted) (Continued)

Characteristics	Symbol	Min	TYP	Max	Unit
-----------------	--------	-----	-----	-----	------

ON CHARACTERISTICS

DC Current Gain ($I_C = -100\text{ mA}$, $V_{CE} = -1.0\text{ Vdc}$)	$h_{FE(1)}$	85	-	400	-
DC Current Gain ($I_C = -800\text{ mA}$, $V_{CE} = -1.0\text{ Vdc}$)	$h_{FE(2)}$	40	-	-	-
Collector-Emitter Saturation Voltage ($I_C = -800\text{ mA}$, $I_B = -80\text{ mA}$)	$V_{CE(sat)}$	-	-	-0.5	Vdc
Base-Emitter Saturation Voltage ($I_C = -800\text{ mA}$, $I_B = -80\text{ mA}$)	$V_{BE(sat)}$	-	-	-1.2	Vdc
Transition Frequency ($V_{CE} = -10\text{ V}$, $I_C = -50\text{ mA}$, $f = 30\text{ MHz}$)	f_T	100	-	-	MHz

Classification of $h_{FE(1)}$

Rank	B	C	D	E
Range	85-160	120-200	160-300	300-400

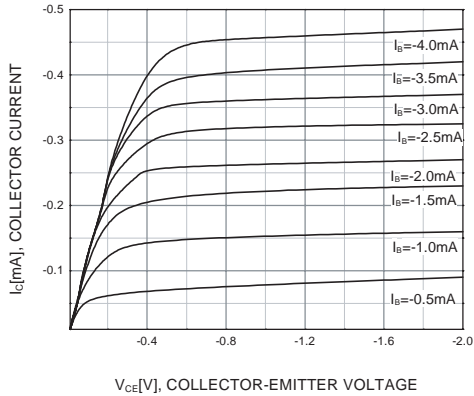

FIG.1 Static Characteristic

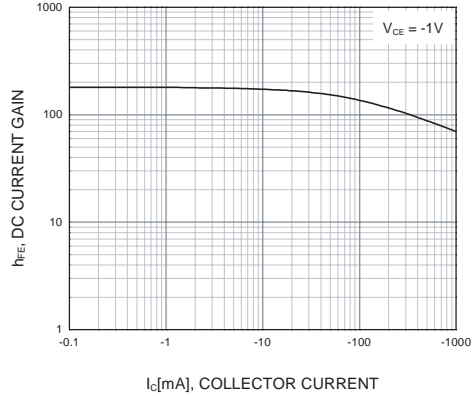

FIG.2 DC Current Gain

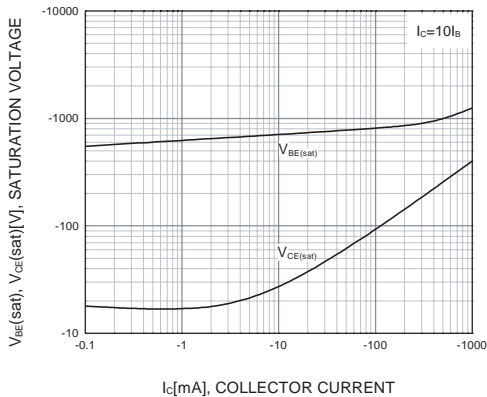

FIG.3 Base-Emitter Saturation Voltage
Collector-Emitter Saturation Voltage

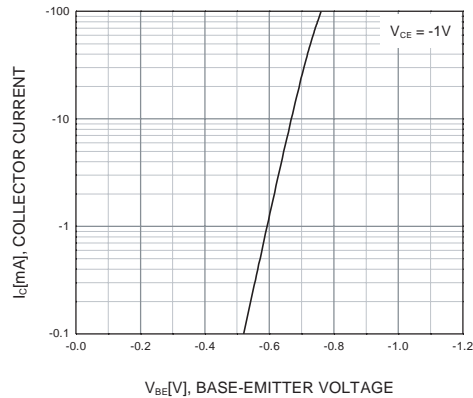

FIG.4 Base-Emitter On Voltage

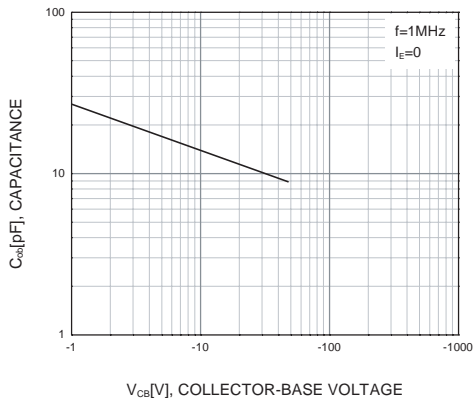

FIG.5 Collector Output Capacitance

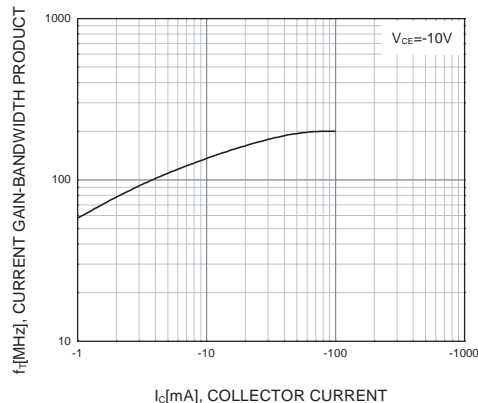
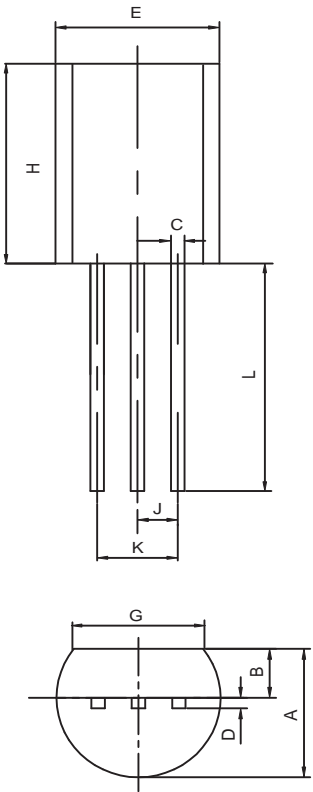

FIG.6 Current Gain Bandwidth Product

TO-92 Outline Dimensions

unit:mm



TO-92		
Dim	Min	Max
A	3.30	3.70
B	1.10	1.40
C	0.38	0.55
D	0.36	0.51
E	4.40	4.70
G	3.43	-
H	4.30	4.70
J	1.270TYP	
K	2.44	2.64
L	14.10	14.50