



结构平面辅料承认书

文件编号: F-ACK-9698

页次: 2/3 页

物料编码: C2826446	承认日期: 2021-04-19	版本	修改内容
物料名称: 灰色矽胶片	产品型号: T0-28	A/0	首次发行
尺寸: 48*28*0.3MM			
公差范围: +/-0.1			
材质: 硅胶			
颜色: 灰色			
符合 ROHS 要求: <input checked="" type="checkbox"/> 是 <input type="checkbox"/> 否			
储存环境: 常温		使用有效期: 五年	

附图: (单位: mm)

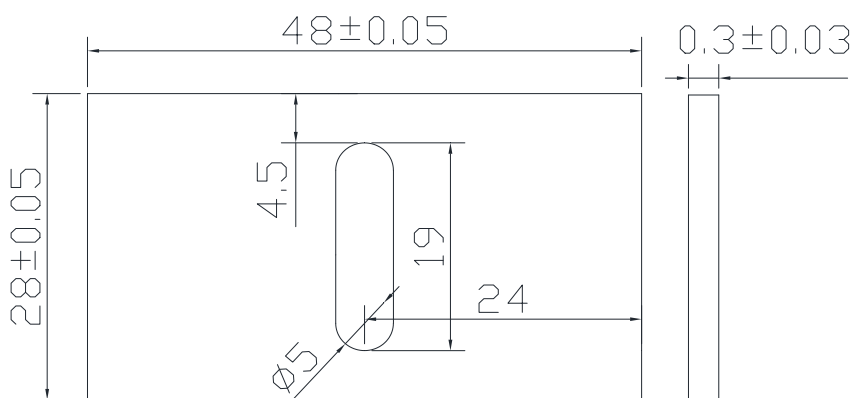

技术要求:

- 1、厚度0.3mm ,灰色。UL认证号E338508
- 2、阻燃等级:94V-2,耐高温-40~+200C, 耐压:4KV
- 3、导热系数:1.0W/m.K,热阻:0.75~°C/W
- 4、定位公差±0.1mm,外形公差±0.2mm
- 5、表面不能有划伤碰伤,气泡,凹凸包等表面缺陷,去油污
- 6、所有物料符合ROHS

尺寸编号	尺寸规格	测量工具	样品编号							判定结果	
			1#	2#	3#	4#	5#	6#	7#	OK	NG
①	0.3MM	厚度计	0.31	0.3	0.30						
②	28.0MM	游标尺	28.1	28.0	28.0					√	
③	48.0MM	游标尺	48.0	48.0	48.0					√	





深圳市诺德斯特科技有限公司

材质证明书

产品名称: 灰色硅胶片 UL 编号 E338508, NDST-SB-110.

材质组成: 高纯度的混练硅胶, 相应特制散热、防火等进口材料按一定的比例复合研制而成。

有主要物理特性参数:

测试项目	单位	测试方法	测试值
颜色 Color	---	Visual	灰色
厚度 Thickness	Mm	ASTM D374	0.3±0.02
比重 Specific Gravity	g/cm3	ASTM D792	1.7±0.1
硬度 Hardness	Shore A	ASTM D2240	70±5
抗拉强度 Tensile Strength	kg/cm2	ASTM D412	>180
	pa	ASTM D412	1.8*10
耐温范围 Continuous use Temp	℃		-40~+200
伸长率 Elongation	%	ASTM D412	3~8
耐电压 Voltage Endurance	KV/mm	ASTM D149	≥4.0
阻燃性 Flame Rating	---	UL-94	V-2
导热系数 Conductivity	w/m-k	ASTM D5470	1.0

核准: 夏艳丽

制表: 袁素萍

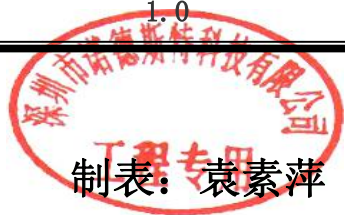

深圳市诺德斯特科技有限公司

包装说明:

- 1.产品名称: 灰色矽胶片.
- 2.产品规格: 48 * 28 * 0.3MM.
- 3.最小包装数量: 1000PCS.
- 4.每箱数量: 1000PCS*40 包=40000PCS

包装示意图片

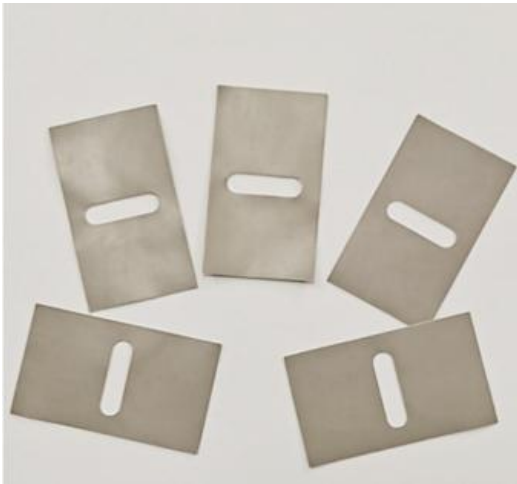

待包装产品



把产品装入 PE 胶袋, 并贴上内标签



装贴好内标签的产品装入纸箱, 每箱 40 包



装箱, 并贴上外标签及 ROHS 标签后封箱





深圳市诺德斯特科技有限公司

产品概述 / introduction



绝缘导热矽胶片是以硅胶及玻璃纤维为基材通过特殊工艺生产出来的布状绝缘制品。因其优良的导热、绝缘及装配方便等特性，被广泛应用于电、绝缘等行业。使用时，根据发热界面的大小及间隙高度选择不同厚度的导热矽胶片进行裁切，与导热硅脂配合使用导热效果更佳。

T0-28 有孔标准规格 (48*28*0.3MM)

绝缘导热矽胶布整卷为 300mm*50M/卷，可根据客户要求裁要或模切成不同形状大小。

产品特点 / Features

- >> 导热 绝缘 防震 高韧性抗撕裂
- >> 耐磨抗刺穿 使用寿命长
- >> 有效降低发热源与散热器间的热阻
- >> 可背胶 与硅脂配合使用效果更佳
- >> 满足ROHS及UL的环境要求



应用范围 / Application



显卡、显存、南北桥



高速硬盘驱动器



RDRAM内存模块



微型热管散热器



汽车发动机控制装置



通讯硬件



物质安全资料表

Material Safety Data Sheet



一. 物品名称与厂商资料:

Identification Of The Substance / Preparation And Company.

物品名称(Product Information): 导热硅胶片					
物品编号(Product Number): CP-120-T150					
制造商或供应商名称(Manufacturer/Supplier):					
深圳市诺德斯特科技有限公司 (SHENZHEN NOU DE SI TE CHNOLOGY CO., LTD.)					
地址/电话(Address/Phone): 深圳市宝安区观澜牛湖君新路法尔达工业园					
SHENZHEN BAOAN GUANLAN HUANGUAN ZHONGLU SHITAI GONGYIYUAN TEL: (86)0755-29527673/81368872					
紧急联络电话/传真电话: 电话(86)0755-29527673 传真: (86)0755-29527674					
Emergency Phone/Fax: Tel: (86)0755-29527673 Fax: (86)0755-29527674					
文件编号	Q0-10-001	版次	A.0	文件类别	环境手册
Document No.		Version		Document Type	

二. 成份辨别资料(Composition/Information On Ingredients):

硅胶(Silicone)

中英文名称(English Name):
同义名称(Synonyms): --
化学文摘社登记号码 Chemical Abstracts Number (CAS NO.): --
危害物质成份百分比 Percentage for Chemical Ingredieng (%): --

混合物(Mixture)

化学性质(Cheical Characteristics):		
危害物质成份之中英文名称	浓度或浓度范围(成百分比)	危害物质分类及图式
Hazardus Components Name	Concentration/Percentage	Hazard Symbols

物质安全资料表

Material Safety Data Sheet

三. 危害辨别资料(Hazard Identification):

最重要危害与效应 Major Hazard Effect	健康危害效应(Hazard warnings for Health):无 (NO)
	环境影响(Hazard warnings for Environment):无 (NO)
Major Hazard Effect	物理性及化学性危害(Physical and Chemical Dangerous):无 (NO)
	特殊危害(Special Harm):无 (NO)
主要症状 Major State	无 (NO)
物品危害分类 Hazard classification	无 (NO)

四. 急救措施(Firs Aid Measures):

皮肤接触 Skin Contact	无影响 (NO)
眼睛接触 Eye Contact	及时就医(Call a physician immediately)
食入 Ingestion	及时就医(Call a physician immediately)

五. 灭火措施(Fire Fighting Measure):

适用灭火剂(Suitable extinguishing media):干粉(Foam, dry chemical, carbon dioxide)
灭火时可能遭遇之特殊危害 Special exposure hazards:无 (NO)
特殊灭火程序(Special Extinguishing procedure):移动燃源, 用灭火器或用水灭火 (Remove away from the heat, extinguish by water or other media)
消防人员之特殊防护设备(Special protection equipment):无特殊防护 (NO)

六. 泄漏处理方法(Accidental Release Measures):

个人应注意事项(Personal protection):
本产品为固体 无泄漏处理. (The product exists solid state, no leakage will happen.)
环境注意事项(Environment protection):无 (NO)
清理方法(Methods for Cleaning up):无 (NO)



物质安全资料表

Material Safety Data Sheet

七. 安全处理与储存方法(Handling and Storage):

处置(Handling): 无需特殊防护(No need)

储存(Storage): 低温干燥, 远离明火, 避免阳光直射(Store in a cool place, keep away from heat and flame)

八. 暴露预防措施(Exposure Control/personal protection):

工程控制(Engineering Control): 勿与阳光直接接触(Don't expose under sunshine directly.)

卫生措施(Hygienic procedures): 无资料(N/A)

个人防护设备(Personal protective Equipment): 无需防护(No need)

九. 物理及化学性质(Physical and Chemical properties/Characteristics):

物理状态 Appearance: 固态(Solid)	形状Form: 片状(in piece)
颜色Colour: 各种颜色can be in different colors	气味Odour: 无刺激性气味(Odorless)
PH值 PH Value: 5~7	沸点/沸点范围Boilingpoint/BoilingRange: >700°C
分解温度(Decomposition temperature): 无资料(N/A)	闪光点Flash Point: 无资料(N/A) 测试方法Test Method: 无资料(N/A)
自然温度Spontaneous Temperature: 无资料(N/A)	爆炸界限Explosion Limits: 无资料(N/A)
蒸气压Vapor Pressure: 无资料(N/A)	蒸气密度Vapor Density: 无资料(N/A)
密度Specific Gravity: >1.6(25°C)	溶解度Solubility in water: 无资料(N/A)

十. 安定性及反应性(Stability and Reactivity):

安定性(Stability): 安定(Stable)

特殊状况下可能之危害反应(Special Conditions of Hazardous Reaction): 无资料(N/A)

某些生锈金属: 无资料(N/A)

应避免之状况(Conditions to Avoid): 无资料(N/A)

应避免之物质(Incompatibility): 强碱及强酸(Strong alkalis and strong acids)



物质安全资料表

Material Safety Data Sheet

十一. 毒性资料 (Toxicological information)

急毒性 (Acute toxicity): 无 (No)

局部效应 (Local Effects): 无 (No)

敏感性 (Sensitivity): 无 (No)

慢毒性及长期毒性 (Chronic toxicity): 无 (No)

特殊效应 (Special effect): 无 (No)

十二. 生态资料 (Ecological Information):

可能之环境影响/环境流布 (Possibility of Environmental Impact/move): 对环境无影响
(No harmful effect to environment)

十三. 放弃处置方法 (Disposal Information):

放弃处置方法 (Disposal information): 可回收或再生 (Can be recycled)

十四. 运送资料 (Transport Information):

国际运送规定 (International Transport Regulation): 货柜装箱 及 散装箱 (Container)

联合国编号 The United Nations Number (Un-No): 无 (No)

国内运输规定 (Internal Transport regulation):

用容量 $\leq 10\text{Kg}$ 的纸箱包装

Can be packed in box: $\leq 10\text{Kg}$



十五. 法规资料 (Regulation Information)

适用法规 (Apply Regulation): 无资料 No

十六. 其它资料

制表单位 Make Unit	名称: 深圳市诺德斯特科技有限公司 (SHENZHEN NOU DE SI TE CHNOLOGY CO., LTD.)	
	电话 (86) 0755-29527673/81368872 Tel: (86) 0755-29527673/81368872	传真: (86) 0755-29527674 Fax: (86) 0755-29527674
制表人	职称:	姓名 (Name)
制表日期		

核准:

制表: 彭晓金

Test Report

No. SZXEC2002543403

Date: 23 Oct 2020

Page 1 of 6

SHEN ZHEN SHI NUO DE SI TE TECHNOLOGY CO., LTD

FA ER DA GONG YE YUAN JUN XIN LU NIU HU GUAN LAN SHENZHEN CITY CHINA

The following sample(s) was/were submitted and identified on behalf of the clients as : SILICONE (in Chinese as:矽胶布 矽胶片 绝缘片 硅胶垫)

SGS Job No. : RP20-023016 - SZ
Model No. : NDST
Client Ref. Info. : UL, E338508, ndst-CP-120, ndst-SB-110, ndst-sp-001
Date of Sample Received : 20 Oct 2020
Testing Period : 20 Oct 2020 - 23 Oct 2020
Test Requested : Selected test(s) as requested by client.
Test Method : Please refer to next page(s).
Test Results : Please refer to next page(s).
Conclusion : Based on the performed tests on submitted sample(s), the results of Lead, Mercury, Cadmium, Hexavalent chromium, Polybrominated biphenyls (PBBs), Polybrominated diphenyl ethers (PBDEs) and Phthalates such as Bis(2-ethylhexyl) phthalate (DEHP) , Butyl benzyl phthalate (BBP), Dibutyl phthalate (DBP) , and Diisobutyl phthalate (DIBP) comply with the limits as set by RoHS Directive (EU) 2015/863 amending Annex II to Directive 2011/65/EU.

Signed for and on behalf of
SGS-CSTC Standards Technical Services Co., Ltd. Shenzhen Branch



Andy Ni
Approved Signatory



Unless otherwise agreed in writing, this document is issued by the Company subject to its General Conditions of Service printed overleaf, available on request or accessible at <http://www.sgs.com/en/Terms-and-Conditions.aspx> and, for electronic format documents, subject to Terms and Conditions for Electronic Documents at <http://www.sgs.com/en/Terms-and-Conditions/Terms-e-Documents.aspx>. Attention is drawn to the limitation of liability, indemnification and jurisdiction issues defined therein. Any holder of this document is advised that information contained hereon reflects the Company's findings at the time of its intervention only and within the limits of Client's instructions, if any. The Company's sole responsibility is to its Client and this document does not exonerate parties to a transaction from exercising all their rights and obligations under the transaction documents. This document cannot be reproduced except in full, without prior written approval of the Company. Any unauthorized alteration, forgery or falsification of the content or appearance of this document is unlawful and offenders may be prosecuted to the fullest extent of the law. Unless otherwise stated the results shown in this test report refer only to the sample(s) tested.
Attention: To check the authenticity of testing /inspection report & certificate, please contact us at telephone: (86-755) 8307 1443, or email: CN.Doccheck@sgs.com
SGS Bldg, No.4, Jiaohao Industrial Park, No.430, Jihua Road, Bantian, Longgang District, Shenzhen, China 518129 t (86-755) 25328888 f (86-755) 83106190 www.sgs.com.cn
中国·深圳·龙岗区坂田吉华路430号江灏工业园4栋SGS大楼 邮编: 518129 t (86-755) 25328888 f (86-755) 83106190 e sgs.china@sgs.com

Test Results :

Test Part Description :

Specimen No.	SGS Sample ID	Description
SN1	SZX20-025434.002	Gray silicone sheet

Remarks :

- (1) 1 mg/kg = 1 ppm = 0.0001%
- (2) MDL = Method Detection Limit
- (3) ND = Not Detected (< MDL)
- (4) "-" = Not Regulated

RoHS Directive (EU) 2015/863 amending Annex II to Directive 2011/65/EU

Test Method : With reference to IEC 62321-4:2013+AMD1:2017, IEC62321-5:2013, IEC62321-7-2:2017, IEC 62321-6:2015 and IEC62321-8:2017, analyzed by ICP-OES, UV-Vis and GC-MS.

Test Item(s)	Limit	Unit	MDL	002
Cadmium (Cd)	100	mg/kg	2	ND
Lead (Pb)	1,000	mg/kg	2	7
Mercury (Hg)	1,000	mg/kg	2	ND
Hexavalent Chromium (Cr(VI))	1,000	mg/kg	8	ND
Sum of PBBs	1,000	mg/kg	-	ND
Monobromobiphenyl	-	mg/kg	5	ND
Dibromobiphenyl	-	mg/kg	5	ND
Tribromobiphenyl	-	mg/kg	5	ND
Tetrabromobiphenyl	-	mg/kg	5	ND
Pentabromobiphenyl	-	mg/kg	5	ND
Hexabromobiphenyl	-	mg/kg	5	ND
Heptabromobiphenyl	-	mg/kg	5	ND
Octabromobiphenyl	-	mg/kg	5	ND
Nonabromobiphenyl	-	mg/kg	5	ND
Decabromobiphenyl	-	mg/kg	5	ND
Sum of PBDEs	1,000	mg/kg	-	ND
Monobromodiphenyl ether	-	mg/kg	5	ND
Dibromodiphenyl ether	-	mg/kg	5	ND
Tribromodiphenyl ether	-	mg/kg	5	ND
Tetrabromodiphenyl ether	-	mg/kg	5	ND
Pentabromodiphenyl ether	-	mg/kg	5	ND



Test Report

No. SZXEC2002543403

Date: 23 Oct 2020

Page 3 of 6

<u>Test Item(s)</u>	<u>Limit</u>	<u>Unit</u>	<u>MDL</u>	<u>002</u>
Hexabromodiphenyl ether	-	mg/kg	5	ND
Heptabromodiphenyl ether	-	mg/kg	5	ND
Octabromodiphenyl ether	-	mg/kg	5	ND
Nonabromodiphenyl ether	-	mg/kg	5	ND
Decabromodiphenyl ether	-	mg/kg	5	ND
Dibutyl Phthalate (DBP)	1000	mg/kg	50	ND
Butyl benzyl Phthalate (BBP)	1000	mg/kg	50	ND
Bis(2-ethylhexyl) Phthalate (DEHP)	1000	mg/kg	50	ND
Diisobutyl Phthalate (DIBP)	1000	mg/kg	50	ND

Notes :

(1) The maximum permissible limit is quoted from RoHS Directive (EU) 2015/863.

IEC 62321 series is equivalent to EN 62321 series

https://www.cenelec.eu/dyn/www/f?p=104:30:1742232870351101:::FSP_ORG_ID,FSP_LANG_ID:1258637,25

(2) The restriction of DEHP, BBP, DBP and DIBP shall apply to medical devices, including in vitro medical devices, and monitoring and control instruments, including industrial monitoring and control instruments, from 22 July 2021.

(3) The restriction of DEHP, BBP, DBP and DIBP shall not apply to toys which are already subject to the restriction of DEHP, BBP, DBP and DIBP through entry 51 of Annex XVII to Regulation (EC) No 1907/2006.



Unless otherwise agreed in writing, this document is issued by the Company subject to its General Conditions of Service printed overleaf, available on request or accessible at <http://www.sgs.com/en/Terms-and-Conditions.aspx> and, for electronic format documents, subject to Terms and Conditions for Electronic Documents at <http://www.sgs.com/en/Terms-and-Conditions/Terms-e-Documents.aspx>. Attention is drawn to the limitation of liability, indemnification and jurisdiction issues defined therein. Any holder of this document is advised that information contained hereon reflects the Company's findings at the time of its intervention only and within the limits of Client's instructions, if any. The Company's sole responsibility is to its Client and this document does not exonerate parties to a transaction from exercising all their rights and obligations under the transaction documents. This document cannot be reproduced except in full, without prior written approval of the Company. Any unauthorized alteration, forgery or falsification of the content or appearance of this document is unlawful and offenders may be prosecuted to the fullest extent of the law. Unless otherwise stated the results shown in this test report refer only to the sample(s) tested.

Attention: To check the authenticity of testing / inspection report & certificate, please contact us at telephone: (86-755) 8307 1443, or email: CN.Doccheck@sgs.com
 SGS Bldg, No.4, Jianghao Industrial Park, No.430, Jihua Road, Bantian, Longgang District, Shenzhen, China 518129 t (86-755) 25328888 f (86-755) 83106190 www.sgs.com.cn
 中国·深圳·龙岗区坂田吉华路430号江灏工业园4栋SGS大楼 邮编: 518129 t (86-755) 25328888 f (86-755) 83106190 e sgs.china@sgs.com

ATTACHMENTS

Pb/Cd/Hg/Cr⁶⁺/PBBs/PBDEs Testing Flow Chart

1) These samples were dissolved totally by pre-conditioning method according to below flow chart. (Cr⁶⁺ and PBBs/PBDEs test method excluded).

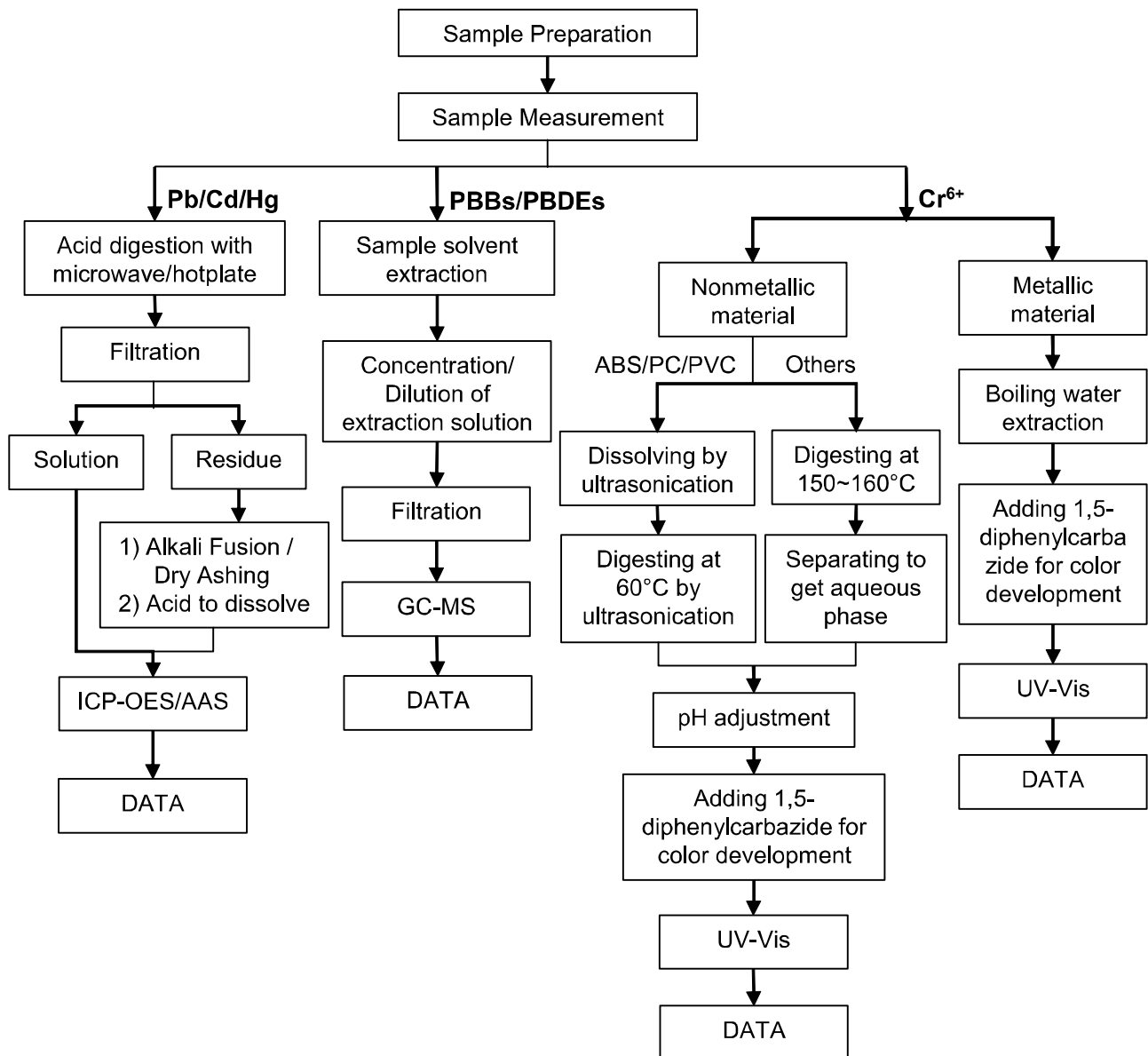

ATTACHMENTS

Phthalates Testing Flow Chart

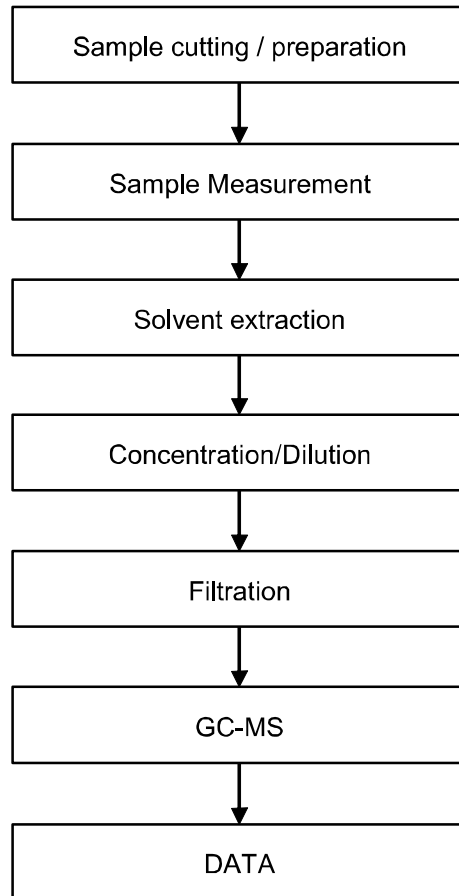

Unless otherwise agreed in writing, this document is issued by the Company subject to its General Conditions of Service printed overleaf, available on request or accessible at <http://www.sgs.com/en/Terms-and-Conditions.aspx> and, for electronic format documents, subject to Terms and Conditions for Electronic Documents at <http://www.sgs.com/en/Terms-and-Conditions/Terms-e-Documents.aspx>. Attention is drawn to the limitation of liability, indemnification and jurisdiction issues defined therein. Any holder of this document is advised that information contained hereon reflects the Company's findings at the time of its intervention only and within the limits of Client's instructions, if any. The Company's sole responsibility is to its Client and this document does not exonerate parties to a transaction from exercising all their rights and obligations under the transaction documents. This document cannot be reproduced except in full, without prior written approval of the Company. Any unauthorized alteration, forgery or falsification of the content or appearance of this document is unlawful and offenders may be prosecuted to the fullest extent of the law. Unless otherwise stated the results shown in this test report refer only to the sample(s) tested.

Attention: To check the authenticity of testing / inspection report & certificate, please contact us at telephone: (86-755) 8307 1443, or email: CN.Doccheck@sgs.com

SGS Bldg, No.4, Jianghao Industrial Park, No.430, Jihua Road, Bantian, Longgang District, Shenzhen, China 518129 t (86-755) 25328888 f (86-755) 83106190 www.sgs.com.cn
中国·深圳·龙岗区坂田吉华路430号江灏工业园4栋SGS大楼 邮编: 518129 t (86-755) 25328888 f (86-755) 83106190 e sgs.china@sgs.com

Sample photo:

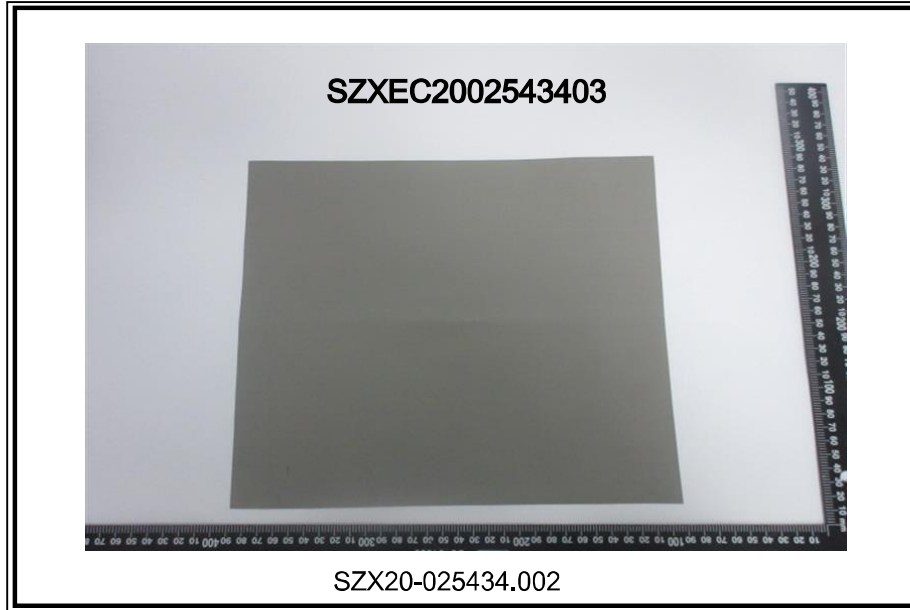

SGS authenticate the photo on original report only

*** End of Report ***



Unless otherwise agreed in writing, this document is issued by the Company subject to its General Conditions of Service printed overleaf, available on request or accessible at <http://www.sgs.com/en/Terms-and-Conditions.aspx> and, for electronic format documents, subject to Terms and Conditions for Electronic Documents at <http://www.sgs.com/en/Terms-and-Conditions/Terms-e-Documents.aspx>. Attention is drawn to the limitation of liability, indemnification and jurisdiction issues defined therein. Any holder of this document is advised that information contained hereon reflects the Company's findings at the time of its intervention only and within the limits of Client's instructions, if any. The Company's sole responsibility is to its Client and this document does not exonerate parties to a transaction from exercising all their rights and obligations under the transaction documents. This document cannot be reproduced except in full, without prior written approval of the Company. Any unauthorized alteration, forgery or falsification of the content or appearance of this document is unlawful and offenders may be prosecuted to the fullest extent of the law. Unless otherwise stated the results shown in this test report refer only to the sample(s) tested.

Attention: To check the authenticity of testing / inspection report & certificate, please contact us at telephone: (86-755) 8307 1443, or email: CN.Doccheck@sgs.com

SGS Bldg, No.4, Jianghao Industrial Park, No.430, Jihua Road, Bantian, Longgang District, Shenzhen, China 518129 t (86-755) 25328888 f (86-755) 83106190 www.sgsgroup.com.cn
中国·深圳·龙岗区坂田吉华路430号江灏工业园4栋SGS大楼 邮编: 518129 t (86-755) 25328888 f (86-755) 83106190 e sgs.china@sgs.com

Test Report

No. SZXEC2002543403

Date: 23 Oct 2020

Page 1 of 6

SHEN ZHEN SHI NUO DE SI TE TECHNOLOGY CO., LTD

FA ER DA GONG YE YUAN JUN XIN LU NIU HU GUAN LAN SHENZHEN CITY CHINA

The following sample(s) was/were submitted and identified on behalf of the clients as : SILICONE (in Chinese as:矽胶布 矽胶片 绝缘片 硅胶垫)

SGS Job No. : RP20-023016 - SZ
Model No. : NDST
Client Ref. Info. : UL, E338508, ndst-CP-120, ndst-SB-110, ndst-sp-001
Date of Sample Received : 20 Oct 2020
Testing Period : 20 Oct 2020 - 23 Oct 2020
Test Requested : Selected test(s) as requested by client.
Test Method : Please refer to next page(s).
Test Results : Please refer to next page(s).
Conclusion : Based on the performed tests on submitted sample(s), the results of Lead, Mercury, Cadmium, Hexavalent chromium, Polybrominated biphenyls (PBBs), Polybrominated diphenyl ethers (PBDEs) and Phthalates such as Bis(2-ethylhexyl) phthalate (DEHP) , Butyl benzyl phthalate (BBP), Dibutyl phthalate (DBP) , and Diisobutyl phthalate (DIBP) comply with the limits as set by RoHS Directive (EU) 2015/863 amending Annex II to Directive 2011/65/EU.

Signed for and on behalf of
SGS-CSTC Standards Technical Services Co., Ltd. Shenzhen Branch



Andy Ni
Approved Signatory



Unless otherwise agreed in writing, this document is issued by the Company subject to its General Conditions of Service printed overleaf, available on request or accessible at <http://www.sgs.com/en/Terms-and-Conditions.aspx> and, for electronic format documents, subject to Terms and Conditions for Electronic Documents at <http://www.sgs.com/en/Terms-and-Conditions/Terms-e-Documents.aspx>. Attention is drawn to the limitation of liability, indemnification and jurisdiction issues defined therein. Any holder of this document is advised that information contained hereon reflects the Company's findings at the time of its intervention only and within the limits of Client's instructions, if any. The Company's sole responsibility is to its Client and this document does not exonerate parties to a transaction from exercising all their rights and obligations under the transaction documents. This document cannot be reproduced except in full, without prior written approval of the Company. Any unauthorized alteration, forgery or falsification of the content or appearance of this document is unlawful and offenders may be prosecuted to the fullest extent of the law. Unless otherwise stated the results shown in this test report refer only to the sample(s) tested.
Attention: To check the authenticity of testing /inspection report & certificate, please contact us at telephone: (86-755) 8307 1443, or email: CN.Doccheck@sgs.com
SGS Bldg, No.4, Jiaohao Industrial Park, No.430, Jihua Road, Bantian, Longgang District, Shenzhen, China 518129 t (86-755) 25328888 f (86-755) 83106190 www.sgs.com.cn
中国·深圳·龙岗区坂田吉华路430号江灏工业园4栋SGS大楼 邮编: 518129 t (86-755) 25328888 f (86-755) 83106190 e sgs.china@sgs.com

Test Results :

Test Part Description :

Specimen No.	SGS Sample ID	Description
SN1	SZX20-025434.002	Gray silicone sheet

Remarks :

- (1) 1 mg/kg = 1 ppm = 0.0001%
- (2) MDL = Method Detection Limit
- (3) ND = Not Detected (< MDL)
- (4) "-" = Not Regulated

RoHS Directive (EU) 2015/863 amending Annex II to Directive 2011/65/EU

Test Method : With reference to IEC 62321-4:2013+AMD1:2017, IEC62321-5:2013, IEC62321-7-2:2017, IEC 62321-6:2015 and IEC62321-8:2017, analyzed by ICP-OES, UV-Vis and GC-MS.

Test Item(s)	Limit	Unit	MDL	002
Cadmium (Cd)	100	mg/kg	2	ND
Lead (Pb)	1,000	mg/kg	2	7
Mercury (Hg)	1,000	mg/kg	2	ND
Hexavalent Chromium (Cr(VI))	1,000	mg/kg	8	ND
Sum of PBBs	1,000	mg/kg	-	ND
Monobromobiphenyl	-	mg/kg	5	ND
Dibromobiphenyl	-	mg/kg	5	ND
Tribromobiphenyl	-	mg/kg	5	ND
Tetrabromobiphenyl	-	mg/kg	5	ND
Pentabromobiphenyl	-	mg/kg	5	ND
Hexabromobiphenyl	-	mg/kg	5	ND
Heptabromobiphenyl	-	mg/kg	5	ND
Octabromobiphenyl	-	mg/kg	5	ND
Nonabromobiphenyl	-	mg/kg	5	ND
Decabromobiphenyl	-	mg/kg	5	ND
Sum of PBDEs	1,000	mg/kg	-	ND
Monobromodiphenyl ether	-	mg/kg	5	ND
Dibromodiphenyl ether	-	mg/kg	5	ND
Tribromodiphenyl ether	-	mg/kg	5	ND
Tetrabromodiphenyl ether	-	mg/kg	5	ND
Pentabromodiphenyl ether	-	mg/kg	5	ND



Test Report

No. SZXEC2002543403

Date: 23 Oct 2020

Page 3 of 6

<u>Test Item(s)</u>	<u>Limit</u>	<u>Unit</u>	<u>MDL</u>	<u>002</u>
Hexabromodiphenyl ether	-	mg/kg	5	ND
Heptabromodiphenyl ether	-	mg/kg	5	ND
Octabromodiphenyl ether	-	mg/kg	5	ND
Nonabromodiphenyl ether	-	mg/kg	5	ND
Decabromodiphenyl ether	-	mg/kg	5	ND
Dibutyl Phthalate (DBP)	1000	mg/kg	50	ND
Butyl benzyl Phthalate (BBP)	1000	mg/kg	50	ND
Bis(2-ethylhexyl) Phthalate (DEHP)	1000	mg/kg	50	ND
Diisobutyl Phthalate (DIBP)	1000	mg/kg	50	ND

Notes :

(1) The maximum permissible limit is quoted from RoHS Directive (EU) 2015/863.

IEC 62321 series is equivalent to EN 62321 series

https://www.cenelec.eu/dyn/www/f?p=104:30:1742232870351101:::FSP_ORG_ID,FSP_LANG_ID:1258637,25

(2) The restriction of DEHP, BBP, DBP and DIBP shall apply to medical devices, including in vitro medical devices, and monitoring and control instruments, including industrial monitoring and control instruments, from 22 July 2021.

(3) The restriction of DEHP, BBP, DBP and DIBP shall not apply to toys which are already subject to the restriction of DEHP, BBP, DBP and DIBP through entry 51 of Annex XVII to Regulation (EC) No 1907/2006.



Unless otherwise agreed in writing, this document is issued by the Company subject to its General Conditions of Service printed overleaf, available on request or accessible at <http://www.sgs.com/en/Terms-and-Conditions.aspx> and, for electronic format documents, subject to Terms and Conditions for Electronic Documents at <http://www.sgs.com/en/Terms-and-Conditions/Terms-e-Documents.aspx>. Attention is drawn to the limitation of liability, indemnification and jurisdiction issues defined therein. Any holder of this document is advised that information contained hereon reflects the Company's findings at the time of its intervention only and within the limits of Client's instructions, if any. The Company's sole responsibility is to its Client and this document does not exonerate parties to a transaction from exercising all their rights and obligations under the transaction documents. This document cannot be reproduced except in full, without prior written approval of the Company. Any unauthorized alteration, forgery or falsification of the content or appearance of this document is unlawful and offenders may be prosecuted to the fullest extent of the law. Unless otherwise stated the results shown in this test report refer only to the sample(s) tested.

Attention: To check the authenticity of testing / inspection report & certificate, please contact us at telephone: (86-755) 8307 1443, or email: CN.Doccheck@sgs.com
 SGS Bldg, No.4, Jianghao Industrial Park, No.430, Jihua Road, Bantian, Longgang District, Shenzhen, China 518129 t (86-755) 25328888 f (86-755) 83106190 www.sgs.com.cn
 中国·深圳·龙岗区坂田吉华路430号江灏工业园4栋SGS大楼 邮编: 518129 t (86-755) 25328888 f (86-755) 83106190 e sgs.china@sgs.com

ATTACHMENTS

Pb/Cd/Hg/Cr⁶⁺/PBBs/PBDEs Testing Flow Chart

1) These samples were dissolved totally by pre-conditioning method according to below flow chart. (Cr⁶⁺ and PBBs/PBDEs test method excluded).

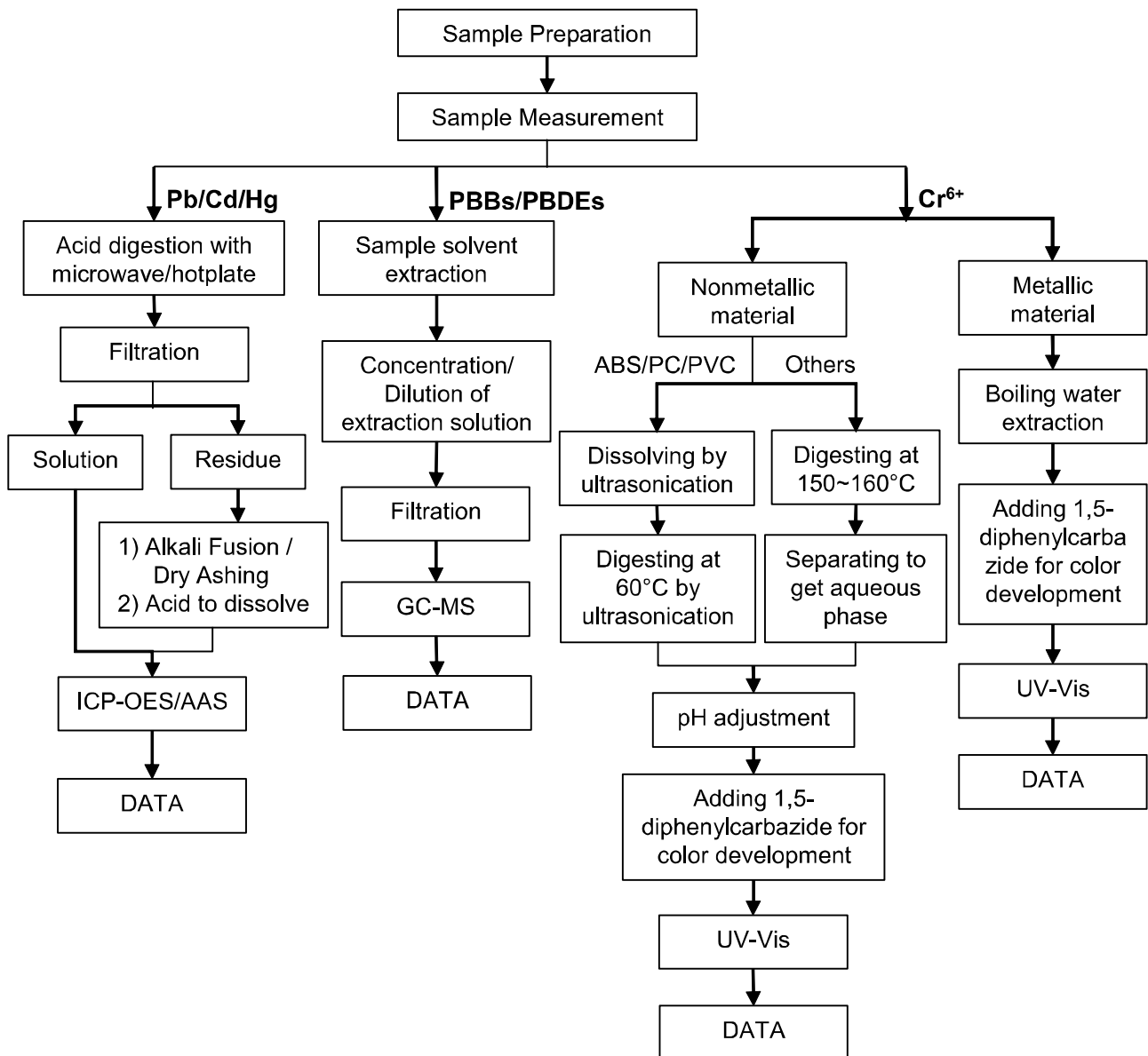

Unless otherwise agreed in writing, this document is issued by the Company subject to its General Conditions of Service printed overleaf, available on request or accessible at <http://www.sgs.com/en/Terms-and-Conditions.aspx> and, for electronic format documents, subject to Terms and Conditions for Electronic Documents at <http://www.sgs.com/en/Terms-and-Conditions/Terms-e-Documents.aspx>. Attention is drawn to the limitation of liability, indemnification and jurisdiction issues defined therein. Any holder of this document is advised that information contained hereon reflects the Company's findings at the time of its intervention only and within the limits of Client's instructions, if any. The Company's sole responsibility is to its Client and this document does not exonerate parties to a transaction from exercising all their rights and obligations under the transaction documents. This document cannot be reproduced except in full, without prior written approval of the Company. Any unauthorized alteration, forgery or falsification of the content or appearance of this document is unlawful and offenders may be prosecuted to the fullest extent of the law. Unless otherwise stated the results shown in this test report refer only to the sample(s) tested.

Attention: To check the authenticity of testing / inspection report & certificate, please contact us at telephone: (86-755) 8307 1443, or email: CN.Doccheck@sgs.com

SGS Bldg, No.4, Jianghao Industrial Park, No.430, Jihua Road, Bantian, Longgang District, Shenzhen, China 518129 t (86-755) 25328888 f (86-755) 83106190 www.sgs.com.cn
 中国·深圳·龙岗区坂田吉华路430号江源工业园4栋SGS大楼 邮编: 518129 t (86-755) 25328888 f (86-755) 83106190 e sgs.china@sgs.com

ATTACHMENTS

Phthalates Testing Flow Chart

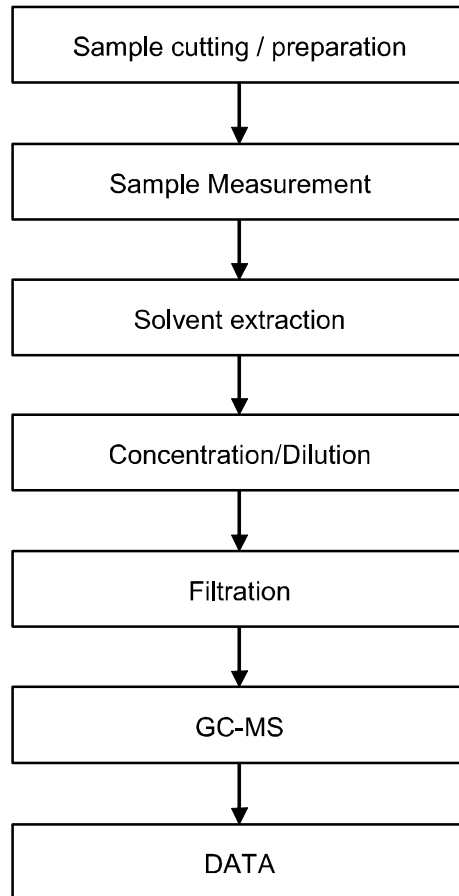

Unless otherwise agreed in writing, this document is issued by the Company subject to its General Conditions of Service printed overleaf, available on request or accessible at <http://www.sgs.com/en/Terms-and-Conditions.aspx> and, for electronic format documents, subject to Terms and Conditions for Electronic Documents at <http://www.sgs.com/en/Terms-and-Conditions/Terms-e-Documents.aspx>. Attention is drawn to the limitation of liability, indemnification and jurisdiction issues defined therein. Any holder of this document is advised that information contained hereon reflects the Company's findings at the time of its intervention only and within the limits of Client's instructions, if any. The Company's sole responsibility is to its Client and this document does not exonerate parties to a transaction from exercising all their rights and obligations under the transaction documents. This document cannot be reproduced except in full, without prior written approval of the Company. Any unauthorized alteration, forgery or falsification of the content or appearance of this document is unlawful and offenders may be prosecuted to the fullest extent of the law. Unless otherwise stated the results shown in this test report refer only to the sample(s) tested.

Attention: To check the authenticity of testing / inspection report & certificate, please contact us at telephone: (86-755) 8307 1443, or email: CN.Doccheck@sgs.com

SGS Bldg, No.4, Jianghao Industrial Park, No.430, Jihua Road, Bantian, Longgang District, Shenzhen, China 518129 t (86-755) 25328888 f (86-755) 83106190 www.sgs.com.cn
中国·深圳·龙岗区坂田吉华路430号江灏工业园4栋SGS大楼 邮编: 518129 t (86-755) 25328888 f (86-755) 83106190 e sgs.china@sgs.com

Sample photo:

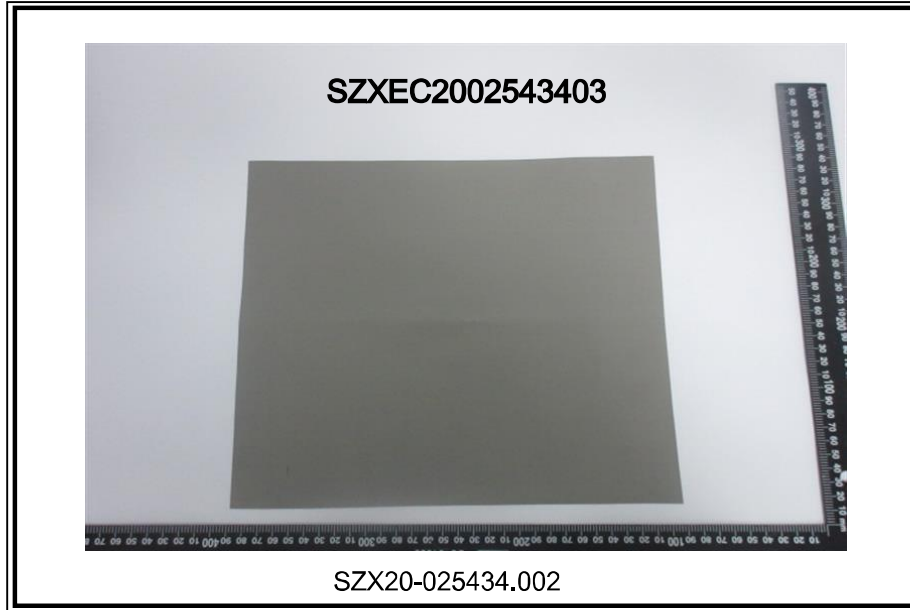

SGS authenticate the photo on original report only

*** End of Report ***



Unless otherwise agreed in writing, this document is issued by the Company subject to its General Conditions of Service printed overleaf, available on request or accessible at <http://www.sgs.com/en/Terms-and-Conditions.aspx> and, for electronic format documents, subject to Terms and Conditions for Electronic Documents at <http://www.sgs.com/en/Terms-and-Conditions/Terms-e-Documents.aspx>. Attention is drawn to the limitation of liability, indemnification and jurisdiction issues defined therein. Any holder of this document is advised that information contained hereon reflects the Company's findings at the time of its intervention only and within the limits of Client's instructions, if any. The Company's sole responsibility is to its Client and this document does not exonerate parties to a transaction from exercising all their rights and obligations under the transaction documents. This document cannot be reproduced except in full, without prior written approval of the Company. Any unauthorized alteration, forgery or falsification of the content or appearance of this document is unlawful and offenders may be prosecuted to the fullest extent of the law. Unless otherwise stated the results shown in this test report refer only to the sample(s) tested.

Attention: To check the authenticity of testing / inspection report & certificate, please contact us at telephone: (86-755) 8307 1443, or email: CN.Doccheck@sgs.com

SGS Bldg, No.4, Jianghao Industrial Park, No.430, Jihua Road, Bantian, Longgang District, Shenzhen, China 518129 t (86-755) 25328888 f (86-755) 83106190 www.sgsgroup.com.cn
中国·深圳·龙岗区坂田吉华路430号江灏工业园4栋SGS大楼 邮编: 518129 t (86-755) 25328888 f (86-755) 83106190 e sgs.china@sgs.com