

Kinghelm®

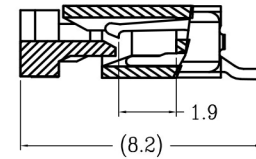

SECTION A-A

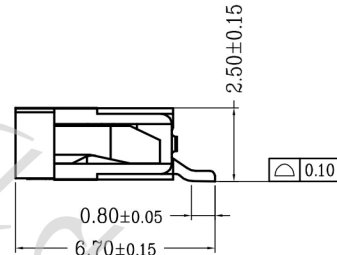
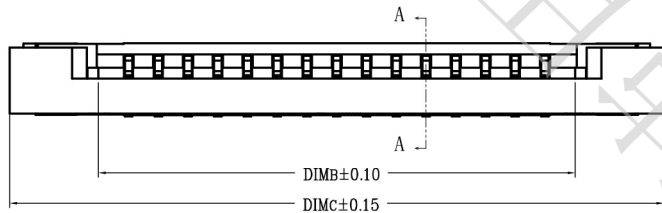
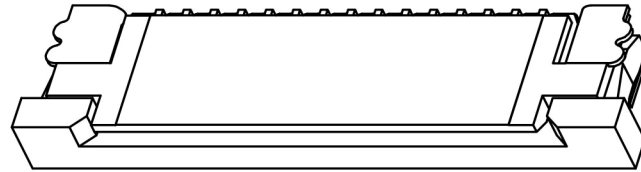
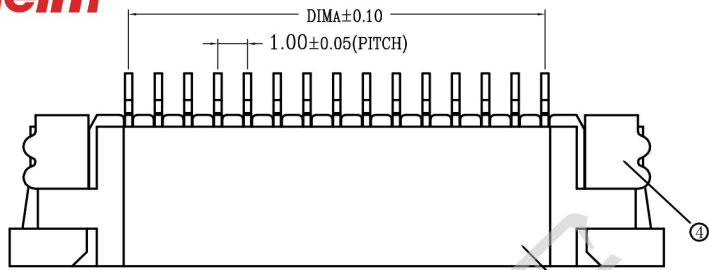
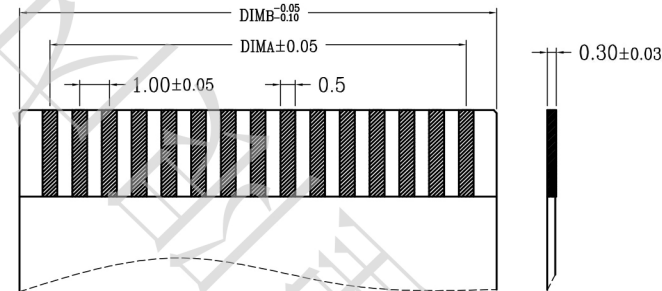
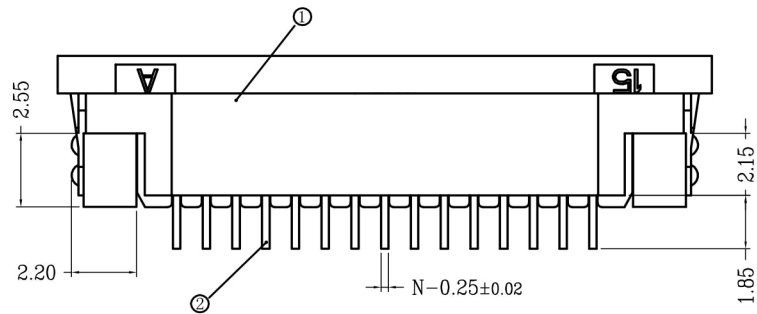

适用扁平线

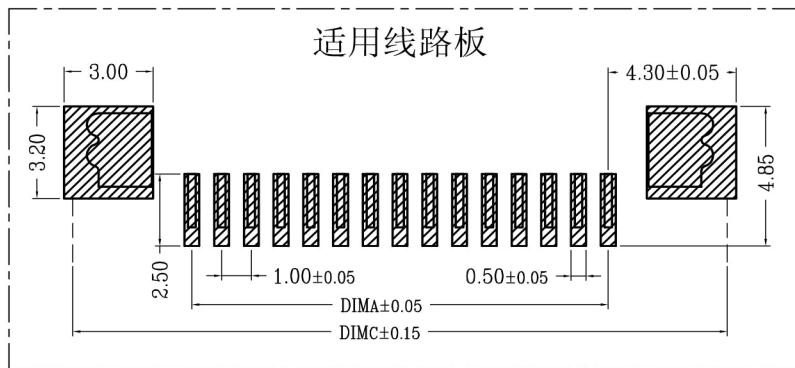

适用线路板

序号	品名	材质
①	1.0K型胶芯 (H2.5)	LCP UL94V-0 本色
②	1.0K型上接端子 (H2.5)	磷青铜/表面镀锡
③	1.0K型后盖 (H2.5)	LCP UL94V-0 黑色
④	1.0K型卧式焊片 (H2.5)	黄铜/表面镀锡

CKT	DIM A	DIM B	DIM C
4	3.00	5.03	11.00
5	4.00	6.03	12.00
6	5.00	7.03	13.00
7	6.00	8.03	14.00
8	7.00	9.03	15.00
9	8.00	10.03	16.00
10	9.00	11.03	17.00
11	10.00	12.03	18.00
12	11.00	13.03	19.00
13	12.00	14.03	20.00
14	13.00	15.03	21.00
15	14.00	16.03	22.00
16	15.00	17.03	23.00
17	16.00	18.03	24.00
18	17.00	19.03	25.00
19	18.00	20.03	26.00
20	19.00	21.03	27.00
21	20.00	22.03	28.00
22	21.00	23.03	29.00
23	22.00	24.03	30.00
24	23.00	25.03	31.00
25	24.00	26.03	32.00
26	25.00	27.03	33.00
27	26.00	28.03	34.00
28	27.00	29.03	35.00
29	28.00	30.03	36.00
30	29.00	31.03	37.00
31	30.00	32.03	38.00
32	31.00	33.03	39.00
33	32.00	34.03	40.00
34	33.00	35.03	41.00
35	34.00	36.03	42.00
36	35.00	37.03	43.00
37	36.00	38.03	44.00
38	37.00	39.03	45.00
39	38.00	40.03	46.00
40	39.00	41.03	47.00

技术指标:

1. 塑件表面应光洁、无毛边、无明显收缩、缺陷、裂纹等现象。
2. 温度范围: -25°C ~ 85°C.
3. 额定电压: 50V, AC/DC(等效).
4. 接触电阻: ≤ 0.03Ω.
5. 绝缘电阻: ≥ 500MΩ

一般公差 (TOLERANCE)
 X ± 0.50 XX ± 1.0
 Y ± 0.20 ZXX ± 0.05
 ANGLES ± 1°

深圳市金航标电子有限公司		WWW.BDS666.COM	
KH-CL1.0-H2.5-40PS		0755-83044319	
品名 (TITLE) 1.0 Pitch K型卧式上接 (H=2.5)		制图 (DR) 王涛	
料号 (DWG.NO) 2051-XXXX		校对 (CHKD) 吴鹏	
比例 (SCALE) 1:1		审核 (APPD) 黄志明	
单位 (UNITS) mm	张数 (SHEET) 1 OF 1	尺寸 (SIZE) A4	REV 1