

Feature

- Compliant with IEEE 802.3ab standard.
- Comply with RoHS requirements.
- Operating temperature range: 0°C to +70°C.
- Storage temperature range: -25°C to +125°C.

Electrical Specifications @ 25°C

OCL:	350uH Min. @100KHz/0.1V with 8mA DC Bias				
Hi-POT :	1500VAC 1mA 2S				
Turn Ratio:	1:1±2%				
LK:	0.5uH Max @100KHz/0.2V				
Cw/w	35pF Max @100KHz/0.2V				
D.C.R:	1.2 ohm Max				
Insertion Loss:	1-100MHz: -1.0dB Max				
Cross Talk :	1-100MHz: -30dB Min				
Return Loss:	1-30MHz	40MHz	50MHz	60-80MHZ	80-100MHZ
	-18dB Min	-14.4dB Min	-13.1dB Min	-12dB Min	-10dB Min

Schematic

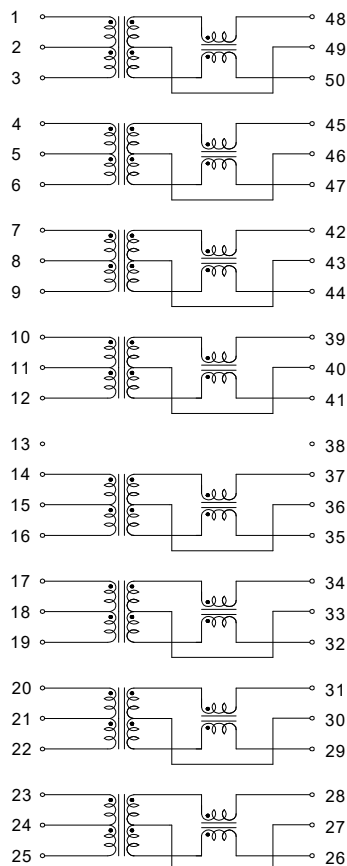

Mechanical

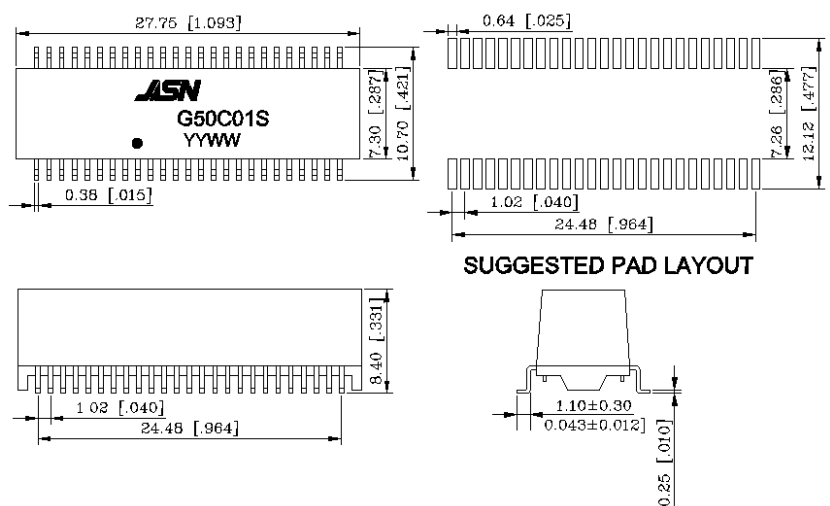

1. Unit: mm[inch]

2. Unless otherwise specified, all tolerances are ±0.25[.01]