

2W isolated DC-DC converter
Fixed input voltage, unregulated single output



CE Patent Protection RoHS



FEATURES

- Continuous short-circuit protection
- No-load input current as low as 8mA
- Operating ambient temperature range: -40°C to +105°C
- High efficiency up to 85%
- Compact SMD package
- I/O isolation test voltage 3k VDC
- Industry standard pin-out
- EN62368 approved

F_XT-2WR3 series are designed for use in distributed power supply systems and especially suitable in applications such as pure digital circuits, low frequency analog circuits, relay-driven circuits and data switching circuits.

Selection Guide

Certification	Part No.	Input Voltage (VDC)	Output		Full Load Efficiency (%) Min./Typ.	Capacitive Load (μF)Max.
		Nominal (Range)	Voltage (VDC)	Current(mA) Max./Min.		
CE	F1205XT-2WR3	12 (10.8-13.2)	5	400/40	79/83	2400
--	F1206XT-2WR3		6	333/33	79/83	1000
	F1209XT-2WR3		9	222/22	79/83	1000
CE	F1212XT-2WR3		12	167/17	80/84	560
	F1215XT-2WR3		15	133/13	80/84	560
	F1224XT-2WR3		24	83/8	81/85	220
--	F1505XT-2WR3	15 (13.5-16.5)	5	400/40	79/83	2400
	F1515XT-2WR3		15	133/13	80/84	560
CE	F2405XT-2WR3	24 (21.6-26.4)	5	400/40	77/83	2400
--	F2409XT-2WR3		9	222/22	77/83	1000
	F2412XT-2WR3		12	167/17	78/84	560
CE	F2415XT-2WR3		15	133/13	78/84	560
	F2424XT-2WR3		24	83/8	79/85	220

Input Specifications

Item	Operating Conditions	Min.	Typ.	Max.	Unit
Input Current (full load / no-load)	12VDC input	--	196/8	--	mA
	15VDC input	--	161/8	--	
	24VDC input	--	98/8	--	
Reflected Ripple Current*		--	30	--	
Surge Voltage (1sec. max.)	12VDC input	-0.7	--	18	VDC
	15VDC input	-0.7	--	21	
	24VDC input	-0.7	--	30	
Input Filter		Capacitance filter			
Hot Plug		Unavailable			

Note: *Reflected ripple current testing method please refer to DC-DC Converter Application Note for specific operation.

Output Specifications

Item	Operating Conditions	Min.	Typ.	Max.	Unit	
Voltage Accuracy		See output regulation curve (Fig. 1)				
Linear Regulation	Input voltage change: ±1%	--	--	±1.2	--	
Load Regulation	10%-100% load	5VDC output	--	7	15	%
		6VDC output	--	7	15	

Load Regulation	10%-100% load	9VDC output	--	6	10	%
		12VDC output	--	5	10	
		15VDC output	--	4	10	
		24VDC output	--	3	10	
Ripple & Noise*	20MHz bandwidth	--	50	150	mVp-p	
Temperature Coefficient	Full load	--	±0.02	--	%/°C	
Short-circuit Protection		Continuous, self-recovery				
Note: * The "parallel cable" method is used for Ripple and Noise test, please refer to DC-DC Converter Application Notes for specific information.						

General Specifications

Item	Operating Conditions	Min.	Typ.	Max.	Unit
Isolation	Input-output electric strength test for 1 minute with a leakage current of 1mA max.	3000	--	--	VDC
Insulation Resistance	Input-output resistance at 500VDC	1000	--	--	MΩ
Isolation Capacitance	Input-output capacitance at 100kHz/0.1V	--	20	--	pF
Operating Temperature	See Fig. 2	-40	--	105	°C
Storage Temperature		-55	--	125	
Case Temperature Rise	Ta=25°C, nominal input voltage, full load	--	25	--	
Storage Humidity	Non-condensing	5	--	95	%RH
Reflow Soldering Temperature*		Peak temp. Tc≤245°C, maximum duration time≤60s over 217°C			
Vibration		10-150Hz, 5G, 0.75mm. along X, Y and Z			
Switching Frequency	Full load, nominal input voltage	--	260	--	kHz
MTBF	MIL-HDBK-217F@25°C	3500	--	--	k hours
Moisture Sensitivity Level (MSL)	IPC/JEDEC J-STD-020D.1	Level 1			
Note: * See also IPC/JEDEC J-STD-020D.1.					

Mechanical Specifications

Case Material	Black plastic; flame-retardant and heat-resistant (UL94 V-0)
Dimensions	13.20 x 11.40 x 7.25 mm
Weight	1.4g(Typ.)
Cooling Method	Free air convection

Electromagnetic Compatibility (EMC)

Emissions	CE	CISPR32/EN55032	CLASS B	
	RE	CISPR32/EN55032	CLASS B	
Immunity	ESD	IEC/EN61000-4-2	Air ±8kV, Contact ±6kV	perf. Criteria B
Note: Refer to Fig.4 for recommended circuit test.				

Typical Characteristic Curves

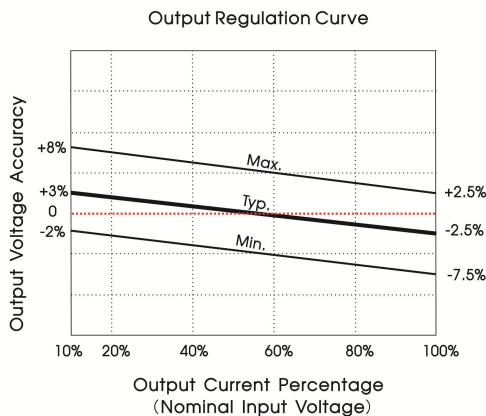

Fig. 1

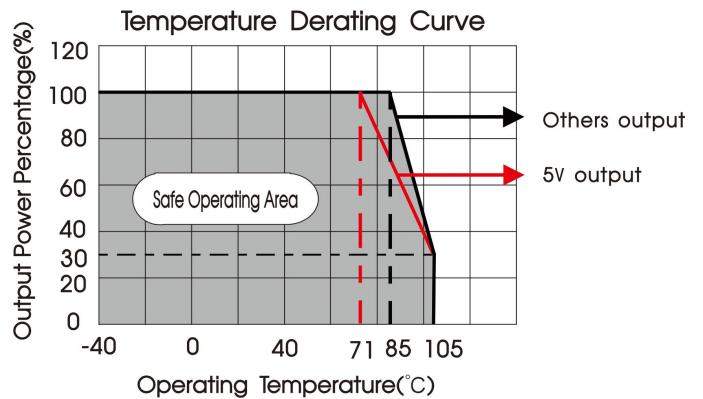
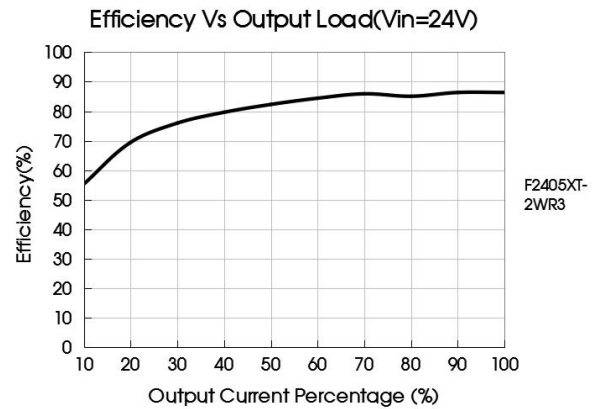
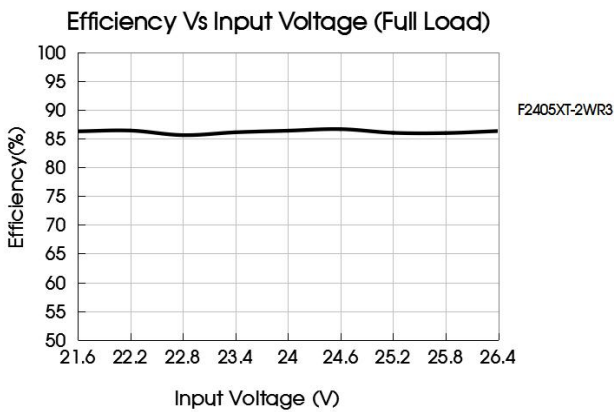
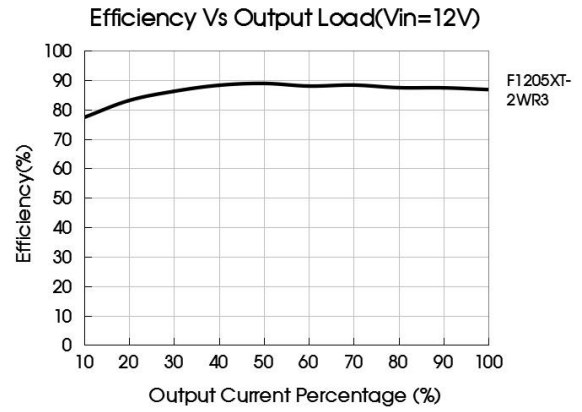
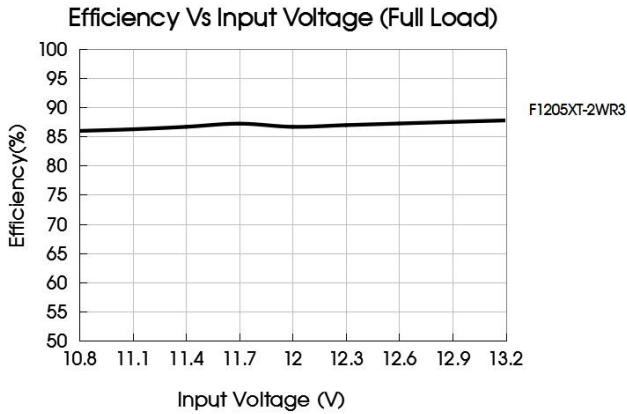

Fig. 2



Design Reference

1. Typical application

Input and/or output ripple can be further reduced, by connecting a filter capacitor from the input and/or output terminals to ground as shown in Fig.3.

Choosing suitable filter capacitor values is very important for a smooth operation of the modules, particularly to avoid start-up problems caused by capacitor values that are too high. For recommended input and output capacitor values refer to Table 1.



Fig.3

Table 1: Recommended input and output capacitor values

Vin	Cin	Vo	Cout
12VDC	2.2μF/25V	5VDC	10μF/10V
15VDC	1μF/25V	6VDC	2.2μF/25V
24VDC	1μF/50V	9VDC	2.2μF/25V
--	--	12VDC	2.2μF/25V
--	--	15VDC	1μF/25V
--	--	24VDC	0.47μF/50V

2. EMC compliance circuit

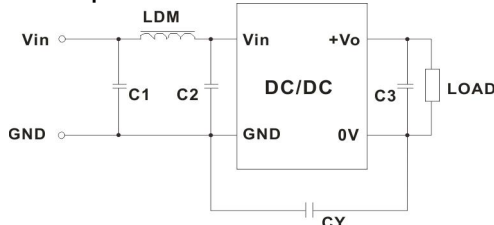

Fig. 4

Emissions	C1, C2	4.7μF /50V
	C3	Refer to the Cout in Fig. 3
	CY	270pF/3kV
	LDM	6.8μH

3. For additional information, please refer to DC-DC converter application notes on www.mornsun-power.com

Dimensions and Recommended Layout

THIRD ANGLE PROJECTION

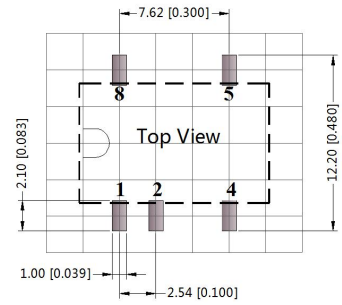
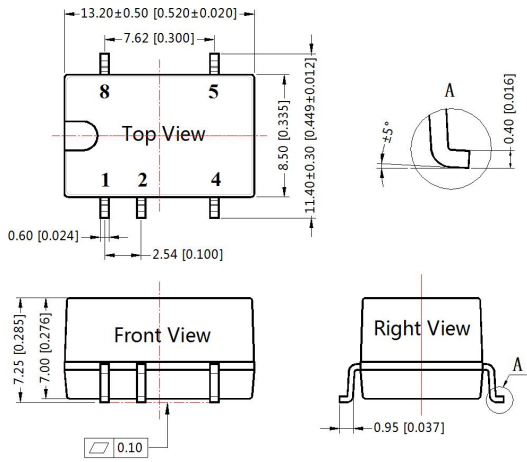

Note: Grid 2.54*2.54mm

Pin-Out	
Pin	Function
1	GND
2	Vin
4	0V
5	+Vo
8	NC

NC: Pin to be isolated from circuitry

Note:
Unit: mm[inch]
Pin section tolerances: ±0.10[±0.004]
General tolerances: ±0.25[±0.010]

Tape and Reel Info

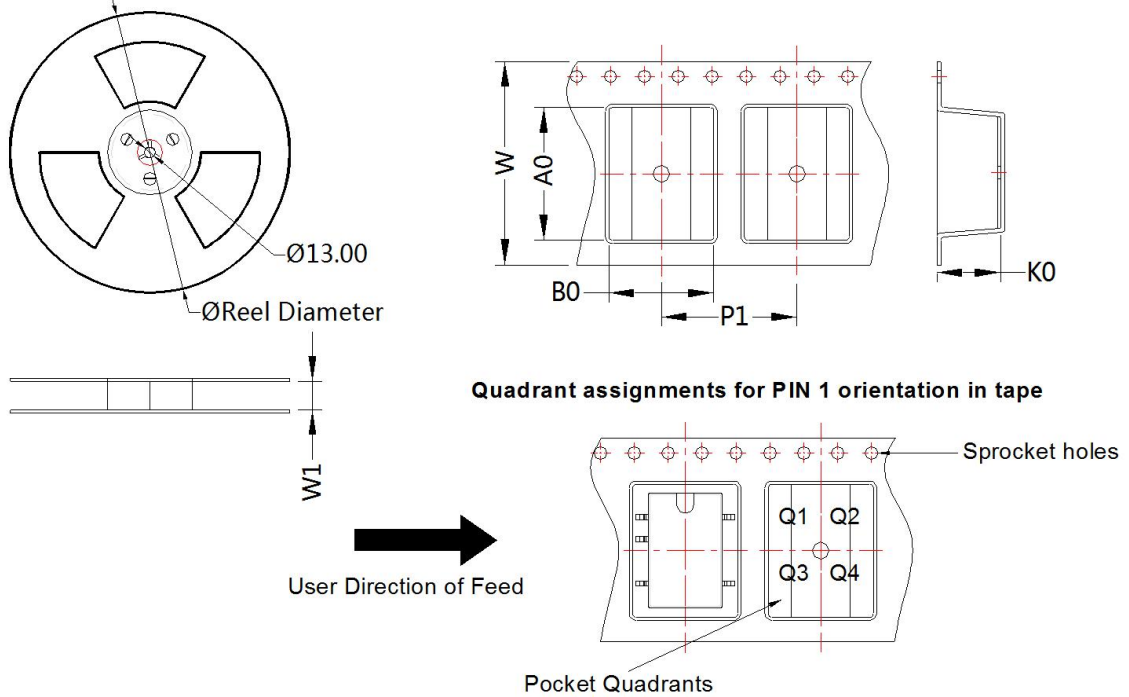

Device	Package Type	Pin	SPQ	Reel Diameter (mm)	Reel Width W1 (mm)	A0 (mm)	B0 (mm)	K0 (mm)	P1 (mm)	W (mm)	Pin1 Quadrant
F_XT-2WR3	SMD	5	500	330.0	24.5	13.4	11.7	7.5	16.0	24.0	Q1

Notes:

1. For additional information on Product Packaging please refer to www.mornsun-power.com. Tube Packaging bag number: 58210024, Roll Packaging bag number: 58200054;
2. If the product is not operated within the required load range, the product performance cannot be guaranteed to comply with all parameters in the datasheet;
3. The maximum capacitive load offered were tested at input voltage range and full load;
4. Unless otherwise specified, parameters in this datasheet were measured under the conditions of $T_a=25^{\circ}\text{C}$, humidity<75%RH with nominal input voltage and rated output load;
5. All index testing methods in this datasheet are based on our company corporate standards;
6. We can provide product customization service, please contact our technicians directly for specific information;
7. Products are related to laws and regulations: see "Features" and "EMC";
8. Our products shall be classified according to ISO14001 and related environmental laws and regulations, and shall be handled by qualified units.

MORNSUN Guangzhou Science & Technology Co., Ltd.

Address: No. 5, Kehui St. 1, Kehui Development Center, Science Ave., Guangzhou Science City, Huangpu District, Guangzhou, P. R. China
Tel: 86-20-38601850 Fax: 86-20-38601272 E-mail: info@mornsun.cn www.mornsun-power.com