

7	8	9	10
MAPX	MODIFICATION		DATE

A
B
C
D
E
F
G

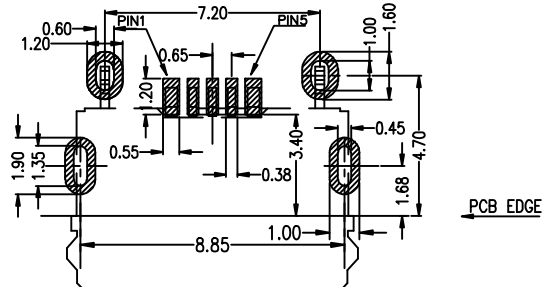
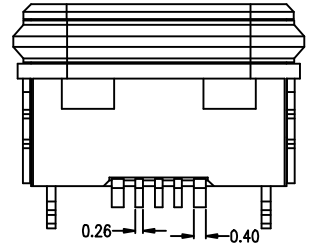
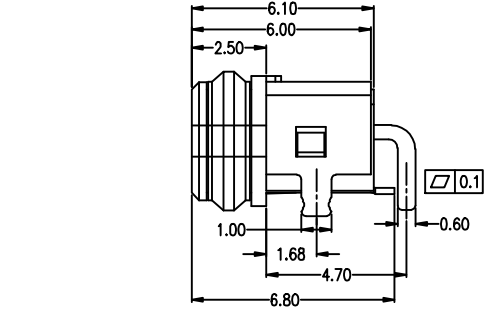
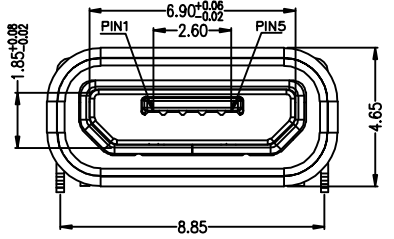
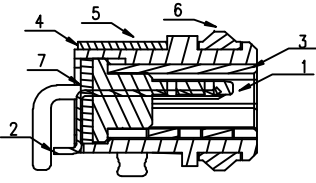
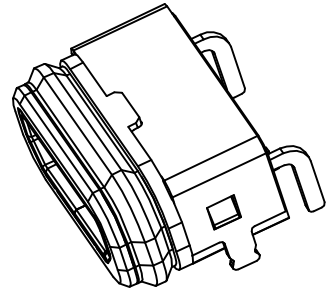
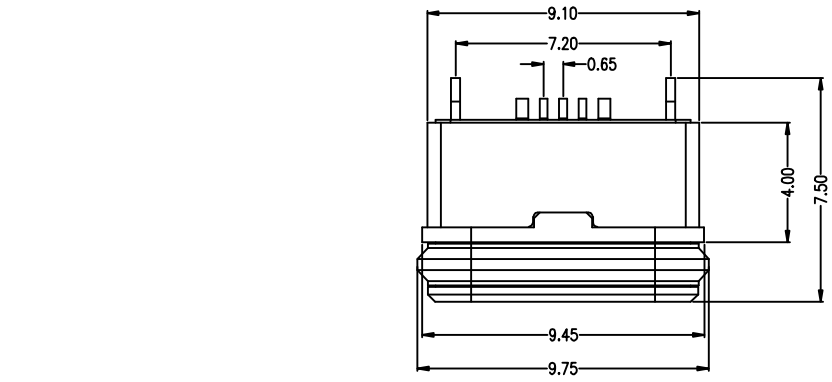

- Note:
- Material:
 - Housing: High temperature thermoplastic
 - Contact: copper alloy, t=0.20mm
 - Shell: SUS304, t=0.30mm
 - cover: High temperature thermoplastic
 - out Shell: SUS304 T=0.25
 - Ring: SILICON
 - Epoxy: Epoxy
 - Specification:
 - Current rating: 1,5PIN 2.0A Max/2,3,4PIN 1A Max.
 - Dielectric withstanding voltage: 100 V(ac) for 1 min.
 - Contact resistance: 30 mΩ Max.
 - Insulation resistance: 100 MΩ Min.
 - Total mating force: 3.57 Kgf Max.
 - Total unmating force: 1.0 Kgf Min.
 - Temperature range: -30°C~80°C
 - Waterproof: IPX 7.

RECOMMEND PCB LAYOUT
PCB图仅供参考

产品图 PRODUCT CHART DWG 公差一览表 TOLERANCE UNLESS OTHERWISE		深圳市精拓金电子有限公司							
X.	±0.30 X.	±5.°	单位 UNITS	MM	制图 DRAWING	YANG	制图料号 PRODUCT PART NO.	920-A64A2051S101A2	
.X	±0.25 .X	±2.°	比例 SCALE	1:1	审核 CHKD	郭志富	产品名称 PRODUCT NO.	MICRO 6PIN 防水A.1圆形插板端子SMT贴片	
.XX	±0.15 .XX	±1.°	日期 DATE	2019.11.23	核准 APPD	黄国荣	角法 VIEW		版本 VER
.XXX	±0.10 .XXX	±0.5'							A0

1 2 3 4 5 6 7 8 9 10