

MAPX	MODIFICATION	DATE

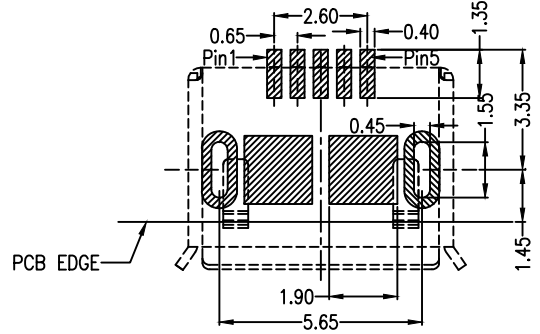
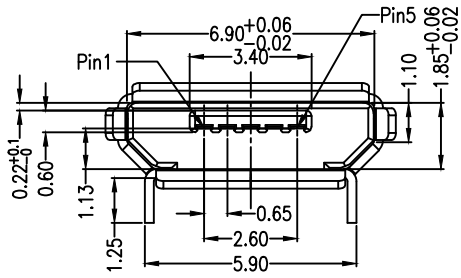
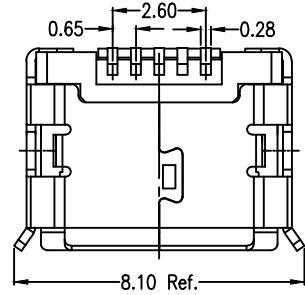
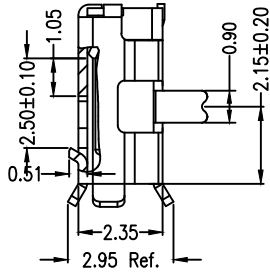
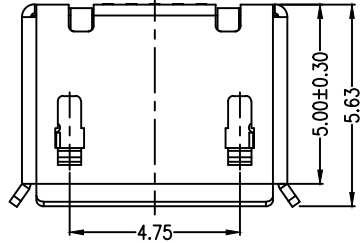
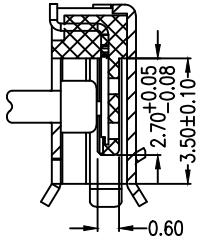
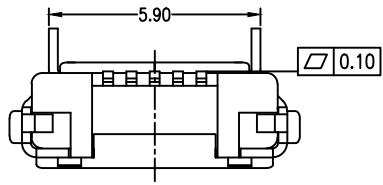

RECOMMENDED PCB LAYOUT  
PCB图仅供参考

- Note:
- Material:
    - Housing: High temperature thermoplastic with g.f,UL94v-0
    - Contact: copper alloy,t=0.20mm
    - Shell: copper alloy,t=0.25mm
  - Specification:
    - Current rating:1,5PIN 1.8A Max/2,3,4PIN 1A Max.
    - Dielectric withstanding voltage: 100 V(ac) for 1 min.
    - Contact resistance: 30 mΩ Max.
    - Insulation resistance: 100 MΩ Min.
    - Total mating force: 3.57 Kgf Max.
    - Total unmating force: 1.0 Kgf Min.
    - Temperature range: -30°C~80°C

产品图 PRODUCT CHART DWG		深圳市精拓金电子有限公司					
公差一览表 TOLERANCE UNLESS OTHERWISE		单位 UNITS	MM	制图 DRAWING	YANG	制图料号 PRODUCT PART NO.	920-C52A2021S10109
X.	±0.30	X.	±5.°	比例 SCALE	审核 CHKD	产品名称 PRODUCT NO.	MICRO 5S B型5.9两脚长1.25插板有边无柱SMI短端
.X	±0.25	.X	±2.°				1:1
.XX	±0.20	.XX	±1.°	日期 DATE	核准 APPD	角法 VIEW	版本 VER
.XXX	±0.10	.XXX	±0.5°	2019.11.23	黄国荣		A0