

RoHS

MAPX

MODIFICATION

DATE

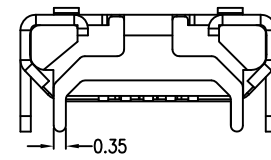
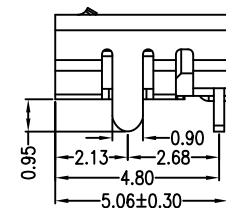
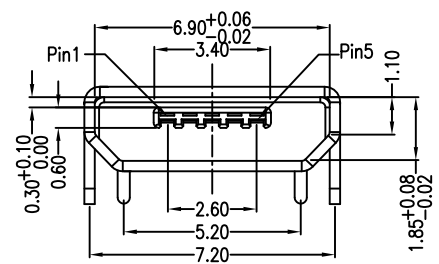
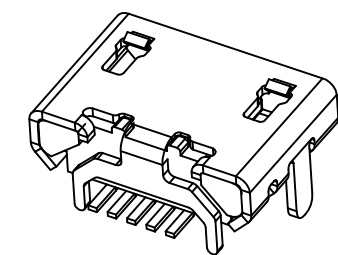
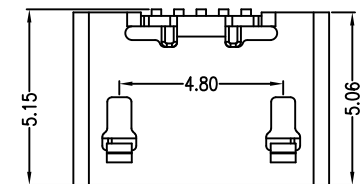

Note:

1.Material:

- 1.1 Housing: High temperature thermoplastic with g.f,UL94v-0
- 1.2 Contact: copper alloy,t=0.15mm
- 1.3 Shell: copper alloy,t=0.30mm

2.Specification:

- 2.1 Current rating:1,5PIN 1.8A Max/2,3,4PIN 1A Max.
- 2.2 Dielectric withstanding voltage: 100 V(ac) for 1 min.
- 2.3 Contact resistance: 30 mΩ Max.
- 2.4 Insulation resistance: 100 MΩ Min.
- 2.5 Total mating force: 3.57 Kgf Max.
- 2.6 Total unmating force: 1.0 Kgf Min.
- 2.7 Temperature range: -30°C~80°C

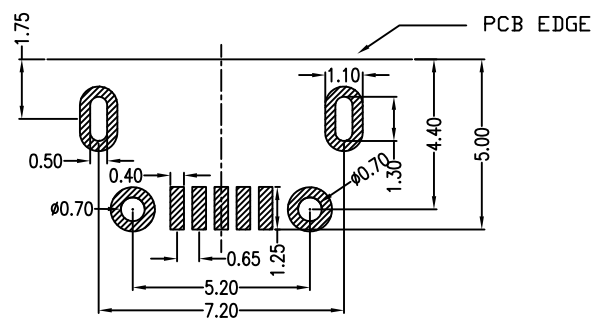
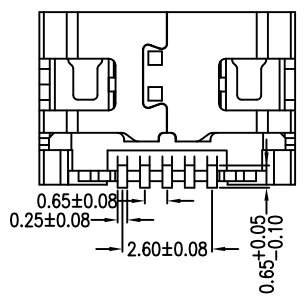
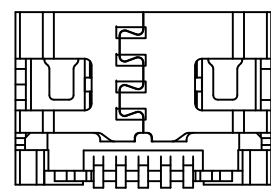

PCB图仅做参考

<p>产品图 PRODUCT CHART DWG</p>				<p>深圳市精拓金电子有限公司</p>						
<p>公差一览表 TOLERANCE UNLESS OTHERWISE</p>				单位 UNITS	MM	制图 DRAWING	尹先华	制图料号 PRODUCT PART NO.	920-E62A2021S10104	
X.	±0.30	X.	±5.°	比例 SCALE	1:1	审核 CHKD	郭治富	产品名称 PRODUCT NAME	MICRO 5-F B型7.2 5.2四牛角型无卷边无柱SMT短针塑胶卷带成品	
.X	±0.25	.X	±2.°	日期 DATE	2021-04-16	核准 APPD	黄国荣	角法 VIEW	版本 VER	AD
.XX	±0.15	.XX	±1.°							
.XXX	±0.10	.XXX	±0.5.°							