

DIGI-KEY CORPORATION

Issue No. : 151XC24C08102

Date of Issue : October 27.2008

Classification :  New  Changed

# PRODUCT SPECIFICATION FOR APPROVAL

Product Description : Common Mode Noise Filter Array (RoHS)

Product Part Number : EXC28CG\*\*\*U

Country of Origin : JAPAN

Applications : Standard electronic equipment

\*If you approve this specification, please fill in and sign the below and return 1 copy to us.

Approval No	:	
Approval Date	:	
Executed by	:	
		<hr/>
		(signature)
Title	:	
Dept.	:	

Circuit Components Business Unit  
Panasonic Electronic Devices Co., Ltd.

401 Sadamasa-cho,  
Fukui City 910-8502 Japan

Phone : +81-776-56-8034

Fax : +81-776-56-3114

Prepared by : Engineering Section

Contact Person :

Signature M.Takeda

Name(Print)

Title :

Authorized by :

Signature Y.Morimoto

Name(Print)

Title : Manager of Engineering

# Panasonic

1. Scope

This specification is applicable to Common Mode Noise Filter, used for general electronic equipment.

2. Dimensions in mm (not to scale)

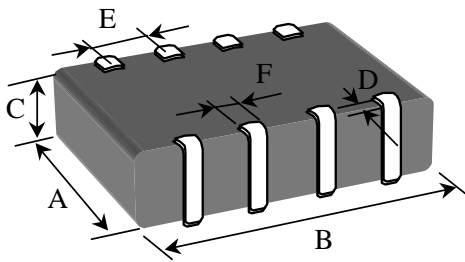

Unit: mm (inch)

A	B	C	D	E	F
1.00±0.15 (.039±.006)	2.0±0.2 (.079±.008)	0.5±0.1 (.020±.004)	0.20±0.15 (.008±.006)	0.5±0.1 (.020±.004)	0.25±0.10 (.010±.004)

3. Structure

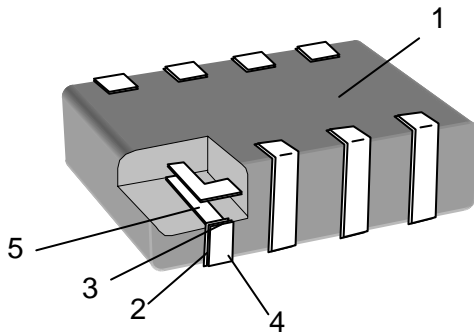

1	Ni-Zn Ferrite
2	Outer Termination(Ag)
3	Ni Plate
4	Sn Plate
5	Inner Conductor(Ag)

4. Schematic

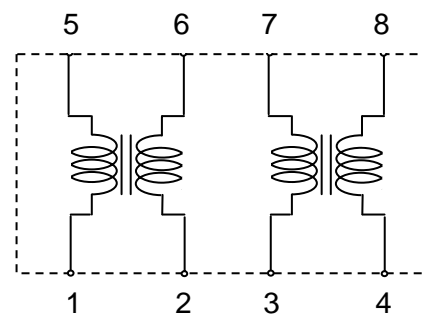
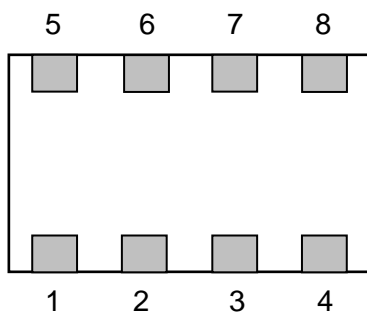

5. Part Number

E X C    2    8    C    G    900    U  
 1)    2)    3)    4)    5)    6)    7)

- 1) Product Code ----- EXC: Noise Suppression Filter
- 2) External Dimensions ----- 2: (L) 1.00 mm
- 3) Number of Terminations ----- 8: 8 pins
- 4) Type ----- C: Coupled Type
- 5) Characteristics ----- G: For Gbps Differential Transmission
- 6) Nominal Impedance Value ----- ex) 900:  $90 \times 10^0 (\Omega)$
- 7) Packaging ----- U: Embossed Tape

6. Rating

Part No.	Common Mode Impedance* <sup>1</sup> at 100MHz	Differential Mode Impedance* <sup>2</sup> at 100MHz	Rated Voltage (V DC)	Rated Current (mA DC)	DC Resistance ( $\Omega$ max.)
EXC28CG240	24( $\Omega$ ) $\pm$ 25(%)	15( $\Omega$ ) max.	5	160	1.5
EXC28CG900	90( $\Omega$ ) $\pm$ 25(%)	17( $\Omega$ ) max.	5	130	3.0

Impedance measurement equipment: HP4291A or Corresponding equipment  
 Impedance measurement circuit:

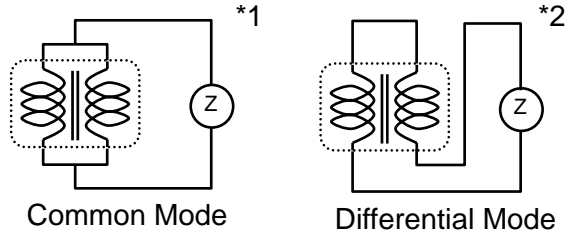

7. Category Temperature Range

-40 to +85 °C

**8. Performance Characteristics**

Standard test condition

- Temperature: 15 to 35 °C
- Relative humidity: 25 to 85 %
- Atmospheric pressure: 86 to 106 kPa

When there are questions concerning measurement result

- Temperature: 20±2 °C
- Relative humidity: 60 to 70 %
- Atmospheric pressure: 86 to 106 kPa

**8-1. Mechanical Characteristics**

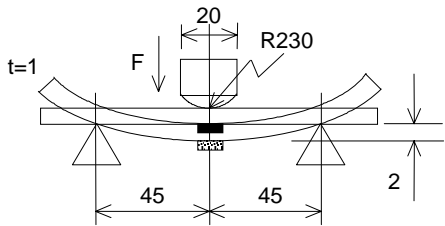
Item	Test Method	Specification
Solderability	Preheating temperature: 150 °C Preheating time: 1 min Solder temperature: 230±5 °C Duration: 4±0.5 s Immersion speed: 25 mm/s	At least 75 % of each termination is covered with the new solder.
Resistance to Soldering Heat	Preheating temperature: 150 °C Preheating time: 1 min Solder temperature: 260±5 °C Duration: 10±0.5 s Immersion speed: 25 mm/s Recovery: 48±4 hours of recovery under the standard condition after the test.	Impedance variation: within ±30 % Remaining terminal: 70 % min.
Bending Strength	Warp: 2 mm Testing board: Glass-epoxy Thickness: 1.0 mm 	No abnormality of appearance Impedance variation: within ±30 %
Vibration	Directions: 2 h each in X, Y, and Z directions (Total: 6 h) Frequency range: 10 to 55 to 10 Hz (Sweep rate: 1 min) Amplitude: 1.5 mm	No abnormality of appearance Impedance variation: within ±30 %

8-2. Environmental Characteristics

Item	Test Method	Specification
Heat Cycle	Conditions for 1 cycle Step 1: -40±3 °C, 30±3 min Step 2: +25±2 °C, 0 to 5 min Step 3: +85±3 °C, 30±3 min Step 4: +25±2 °C, 0 to 5 min Number of cycle: 5 cycle 1 to 2 hours of recovery under the standard condition after the test	No abnormality of appearance Impedance variation: within ±30 %
Load Life	Temperature: 85±2 °C Applied current: Rated current Duration: 500 h 1 to 2 hours of recovery under the standard condition after the test	No abnormality of appearance Impedance variation: within ±30 %
Humidity	Temperature: 40±2 °C Humidity: 90 to 95 %RH Duration: 500 h 1 to 2 hours of recovery under the standard condition after the test	No abnormality of appearance Impedance variation: within ±30 %
Humidity Load Life	Temperature: 40±2 °C Humidity: 90 to 95 %RH Applied current: Rated current Duration: 500 h 1 to 2 hours of recovery under the standard condition after the test	No abnormality of appearance Impedance variation: within ±30 %

9. Packaging Method

9-1. Embossed Carrier Tape

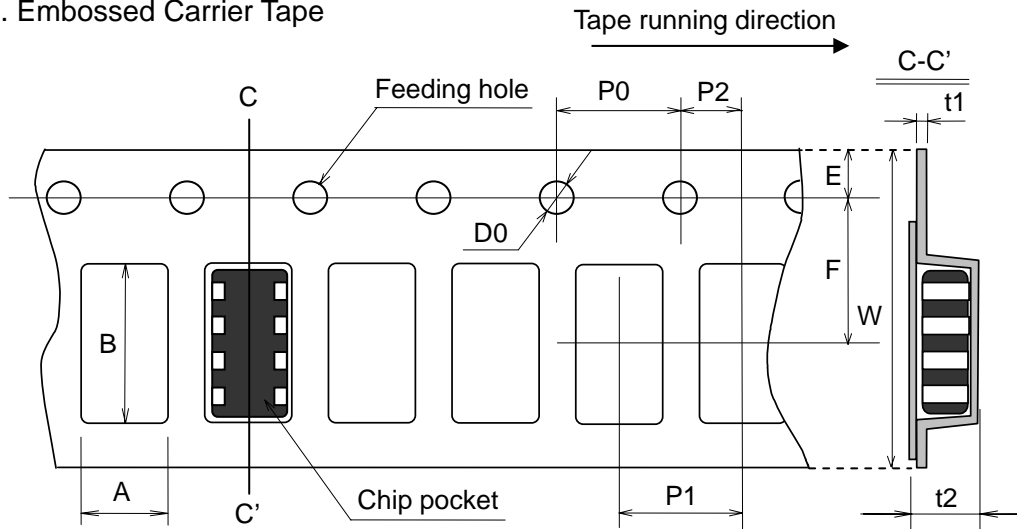

Unit: mm (inch)

A	B	W	F	E	P1
1.20±0.15 (.05±.006)	2.25±0.15 (.09±.006)	8.0±0.2 (.32±.008)	3.5±0.1 (.14±.004)	1.75±0.1 (.07±.004)	4.0±0.1 (.16±.004)
P2	P0	D0	t1	t2	
2.0±0.1 (.08±.004)	4.0±0.1 (.16±.004)	1.5+0.1, -0 (.06+.004, -0)	0.25±0.05 (.01±.002)	0.9±0.15 (.04±.006)	

9-2. Reel

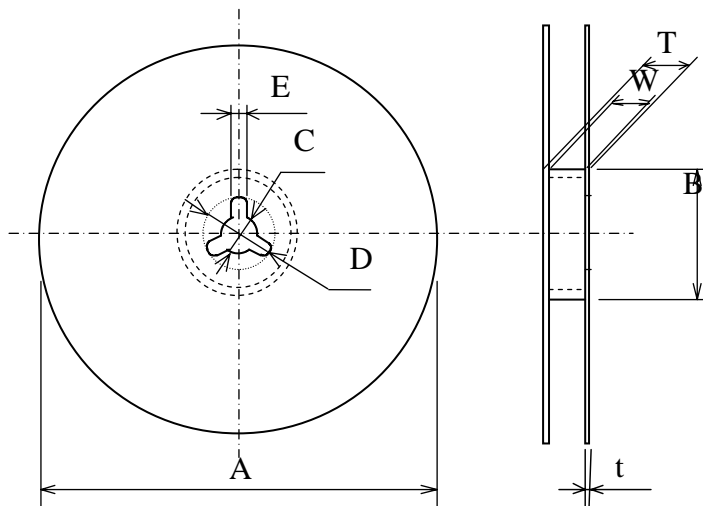

Unit: mm (inch)

A	B	C	D	E	W	T	t
180.0+0/-3 (7.1+0/-12)	60.0+1/-0 (2.4+.04/-0)	13.0±0.2 (.51±.008)	21.0±0.8 (.83±.03)	2.0±0.5 (.08±.02)	9.0±0.3 (.35±.01)	11.4±1.0 (.45±.04)	1.2±0.1 (.04±.004)

9-3. Taping Method

The first end (leader part) and the last end (trailer part) of each tape shall be left empty without loading the product, with the top of the leader part comprising only cover tape. (See the figure below.) The cover tape may not be sealed in the leader part and the trailer part.

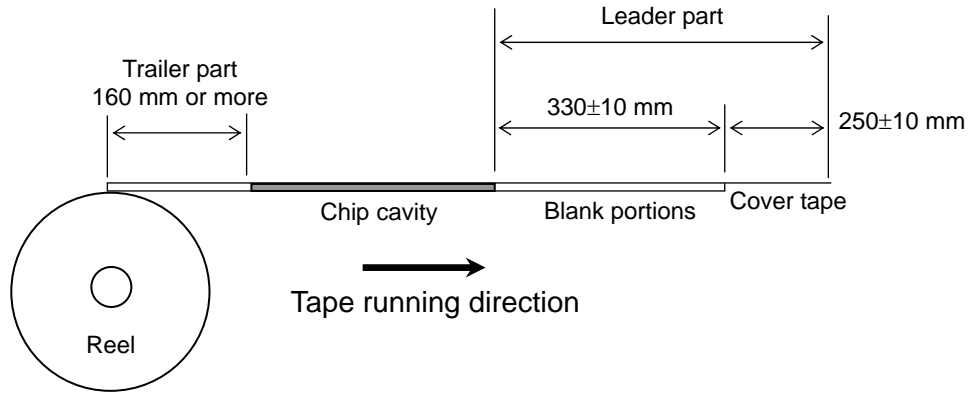

9-4. Peeling Strength of Cover Tape

0.1 to 1.3 N

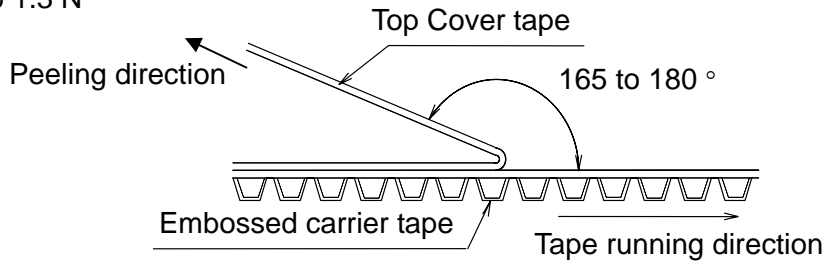

9-5. Label Indication

A label indicating the following in English shall be put on each reel and box.

- 1) Part Name
- 2) Part No.
- 3) Quantity
- 4) Lot No.

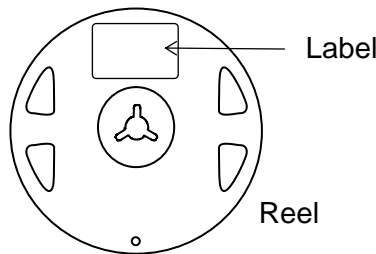

9-6. Package Quantity

Quantity per reel: 5000 pcs.

## 10. Chip-mounting Considerations

### 10-1. Recommended Land Pattern (Only for Reflow Soldering)

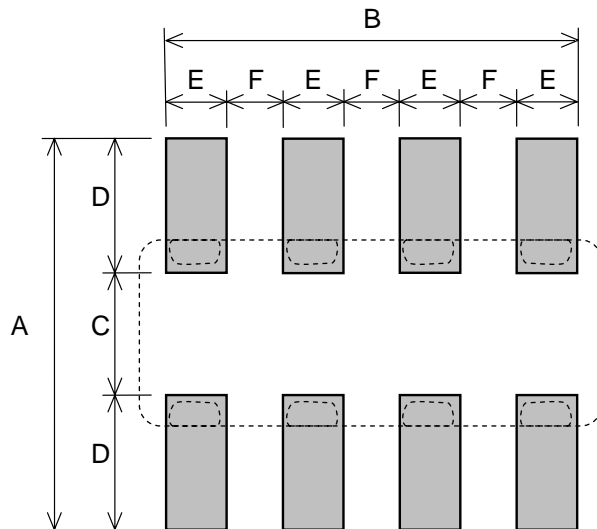

A	1.30 to 1.50 (0.052 to 0.060)
B	1.75 (0.069)
C	0.40 (0.016)
D	0.45 to 0.55 (0.018 to 0.022)
E	0.25 (0.010)
F	0.25 (0.010)

Unit: mm (inch)

- 1) When this products are mounted on a PCB, the amount of solder used (size of fillet) can directly affect this product performance.
- 2) The amount of solder applied can affect the ability of products to withstand mechanical stresses which may lead to breaking or cracking.

Therefore, when designing land-patterns it is necessary to consider the appropriate size and configuration of the solder pads which in turn determines the amount of solder necessary to form the fillets.

### 10-2. Pattern Configurations

- 1) After this products have been mounted on the PC boards, products can be subjected to mechanical stresses in subsequent manufacturing processes. For this reason, planning pattern configurations and the position of SMD inductors should be carefully performed to minimize stress.
- 2) Board separation should not be done manually, but by using the appropriate devices.

### 10-3. Considerations for Automatic Chip-Mounting

Excessive impact load should not be imposed on the inductors when mounting onto the PC boards.



10-4. Reflow Soldering

< Recommended Temperature Profile in Reflow Soldering >

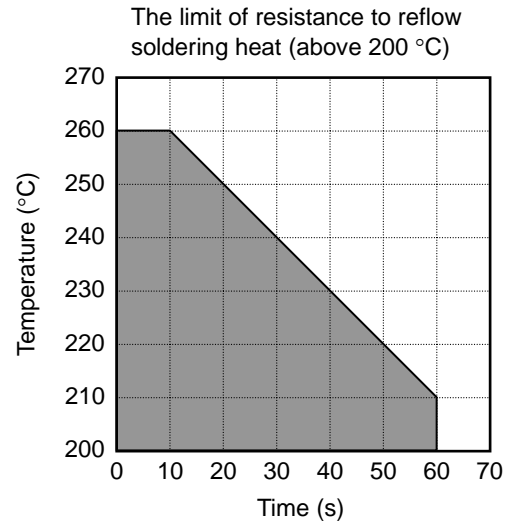
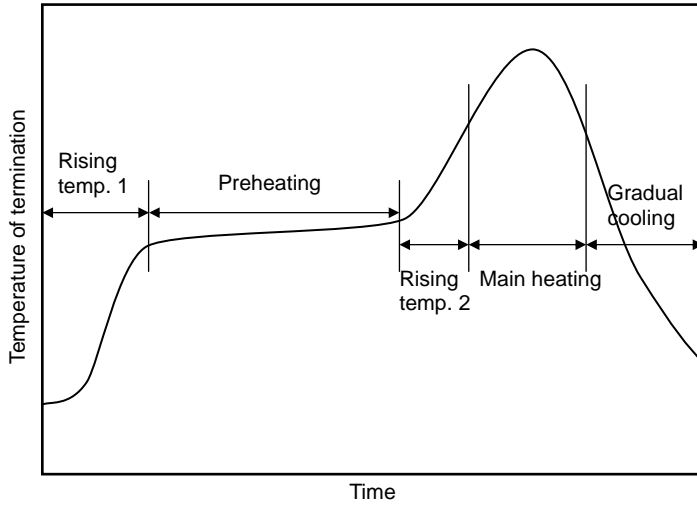

Solder	Rising temp. 1	Preheating	Rising temp. 2	Main heating	Gradual cooling
SnPb eutectic (Sn-37Pb)	The normal to Preheating temp.	140 to 160 °C	Preheating to 200 °C	235±10 °C	200 to 100 °C
	30 to 60 s	60 to 120 s	20 to 40 s	Peak	1 to 4 °C/s
SnAgCu lead-free (Sn-3Ag-0.5Cu)	The normal to Preheating temp.	150 to 170 °C	Preheating to 210 °C	250 <sup>+10</sup> <sub>-5</sub> °C	210 to 100 °C
	30 to 60 s	60 to 120 s	20 to 40 s	Peak	1 to 4 °C/s

- 1) Reflow soldering shall be within twice.
- 2) Please inquire of us when you use the different conditions.
- 3) The temperature may be changed according to the size of the board and the mounting density, etc. Please measure the temperature of termination in each type of the board before actual use.

10-5. Repair with Hand Soldering

- 1) Allow enough preheating with a blast of hot air or similar method. Use a soldering iron with the tip temperature 350 °C or less. Solder for 3 seconds or less for each termination.
- 2) Never touch this product with a tip of the solder iron.

Classification	Specification		No. 151-EXC-28CG205S
Product Name	Common Mode Noise Filter Array (Type EXC28CG)		Page 9 of 11
<p>11. Notice for use</p> <ol style="list-style-type: none"> <li>1. This specification shows the quality and performance of a unit component. Before adoption, be sure to evaluate and verify the product mounting it in your product.</li> <li>2. Precautions on the use of this products. <ol style="list-style-type: none"> <li>1) Do not apply current in excess of the rated value because this product may be high temperature.</li> <li>2) Always wear static control bands to protect against ESD.</li> <li>3) Keep this products away from all magnets and magnetic object.</li> </ol> </li> <li>3. In traffic transportation equipment (trains, cars, traffic signal equipment, etc.), medical equipment, aerospace equipment, electric heating appliances, combustion and gas equipment, disaster and crime preventive equipment, etc. in cases where it is forecast that the failure of this product gives serious damage to the human life and others, use fail-safe design and ensure safety by studying the following items. <ol style="list-style-type: none"> <li>1) Ensure safety as the system by setting protective circuit and protective equipment.</li> <li>2) Ensure safety as the system by setting such redundant circuit as do not cause danger by a signal failure.</li> </ol> </li> <li>4. The products are intended for use in general standard applications for general electronic equipment (AV products, household electric appliances, office equipment, information and communication equipment, etc.); hence, they do not take the use under the following special environments into consideration. Accordingly, the use in the following special environments, and such environmental conditions may affect the performance of the products; prior to use, verify the performance, reliability, etc. thoroughly. <ol style="list-style-type: none"> <li>1) Use in liquids such as water, oil, chemical, and organic solvent</li> <li>2) Where the product is close to a heating component, and where an inflammable such as a polyvinyl chloride wire is arranged close to the product.</li> <li>3) Use in environment with large static electricity and strong electromagnetic waves</li> <li>4) Where water or water-soluble detergent is used in cleaning free soldering or in flux cleaning after soldering(Pay particular attention to soluble flux)</li> <li>5) Storage in places outside the temperature range of -5 to 40 °C and humidity range of 40 to 60 %RH</li> <li>6) Use or storage in places exposed to open-air, dusty atmosphere, and direct sunlight</li> <li>7) Use or storage in places full of corrosive gases such as sea breeze, Cl<sub>2</sub>, H<sub>2</sub>S, NH<sub>3</sub>, SO<sub>2</sub>, and No<sub>x</sub></li> <li>8) Use or storage in such a place where the product is wetted due to dew condensation</li> <li>9) Where the product is sealed or coated with resin, etc.</li> <li>10) Storage over six months after our delivery (This item also applies to the case where the storage method specified in item 5) to 8) has been followed.)</li> </ol> </li> <li>5. In case that there are any doubt about safety problems, please inform us early and be sure to evaluate and verify the product mounting it in your product before adoption.</li> </ol>			
Constitution Sep. 26, 2008	Circuit Components Business Unit Panasonic Electronic Devices Co., Ltd.		

Classification	Specification		No. 151-EXC-28CG205S
Product Name	Common Mode Noise Filter Array (Type EXC28CG)		Page 10 of 11
<p>12. Regulation</p> <ol style="list-style-type: none"> <li>1) This product has not been manufactured with any ozone depleting chemical controlled under the Montreal Protocol .</li> <li>2) All materials used in this product are existing chemical substances recognized under " laws on examination of chemical substances and regulations of manufacturing and others."</li> <li>3) All materials used in this products contain no brominated materials of PBB0s or PBBs as the flame-retardant .</li> <li>4) Please contact us to obtain a notice as to whether this product has passed inspection under review criteria primarily based on Foreign Exchange and Foreign Trade Control law and appended table in the Export Control law.</li> <li>5) This product complies with the RoHS Directive (Restriction of the use of certain Hazardous Substances in electrical and electronic equipment (DIRECTIVE 2002/95/EC)).</li> </ol> <p>13. Production Site</p> <p style="padding-left: 40px;">Panasonic Electronic Devices Japan Co., Ltd. (JAPAN)</p>			
Constitution Sep. 26, 2008	Circuit Components Business Unit Panasonic Electronic Devices Co., Ltd.		

**Impedance Characteristics <Reference Data>**

● EXC28CG900

