



深圳市晶友嘉电子有限公司

SHENZHEN JINGYOUJIA ELECTRONIC CO., LTD



CRYSTAL RESONATOR SPECIFICATIONS

石英晶体谐振器承认书

客户 Customer:	立创商城
型号 Product:	S1C
客户料号 Code No:	
我司料号 Code No:	S1C92160ZWGAC
频率 Frequency:	9.216MHz
数量 Sample Quantity:	
日期 Date:	2021-6-7

深圳市晶友嘉电子有限公司

SHENZHEN JINGYOUJIA ELECTRONIC CO., LTD
深圳市龙华区东环二路数字智能颖博园 B 栋 412

TEL: 86-755-32840201 32850080

FAX: 86-755-84269460

供应商确认栏:

制作 Handler	确认 Checked	核审 Approved
戴晓嘉	陈斌	李晨

客户承认栏:

承认 Checked	核审 Approved

1. Electrical Parameters

No.	Item	Symb	Electrical Specification				Remark
			Min.	Type	Max.	Units	
1	Nominal Frequency	F0	9.216			MHz	
2	Mode of Vibration		Fundamental				
3	Frequency Tolerance	$\Delta F/F0$	-20		20	ppm	At 25°C ± 3°C
4	Operating Temperature Range	TOPR	-20		70	°C	
5	Frequency Stability	TC	-30		30	ppm	
6	Storage Temperature	TSTG	-40		90	°C	
7	Load Capacitance	CL		20		PF	
8	Equivalent Series Resistance	ESR			70	Ω	
9	Drive Level	DL		100		μW	
10	Insulation Resistance	IR	500			MΩ	At 100VDC
11	Shunt Capacitance	C0			7	PF	
12	Motional Capacitance	C1				PF	
13	Aging Per Year	Fa	-3		3	ppm	First Year

2. Equivalent Circuit:



3.实物 Product



4.外型尺寸 Outline Dimensions (unit:mm)

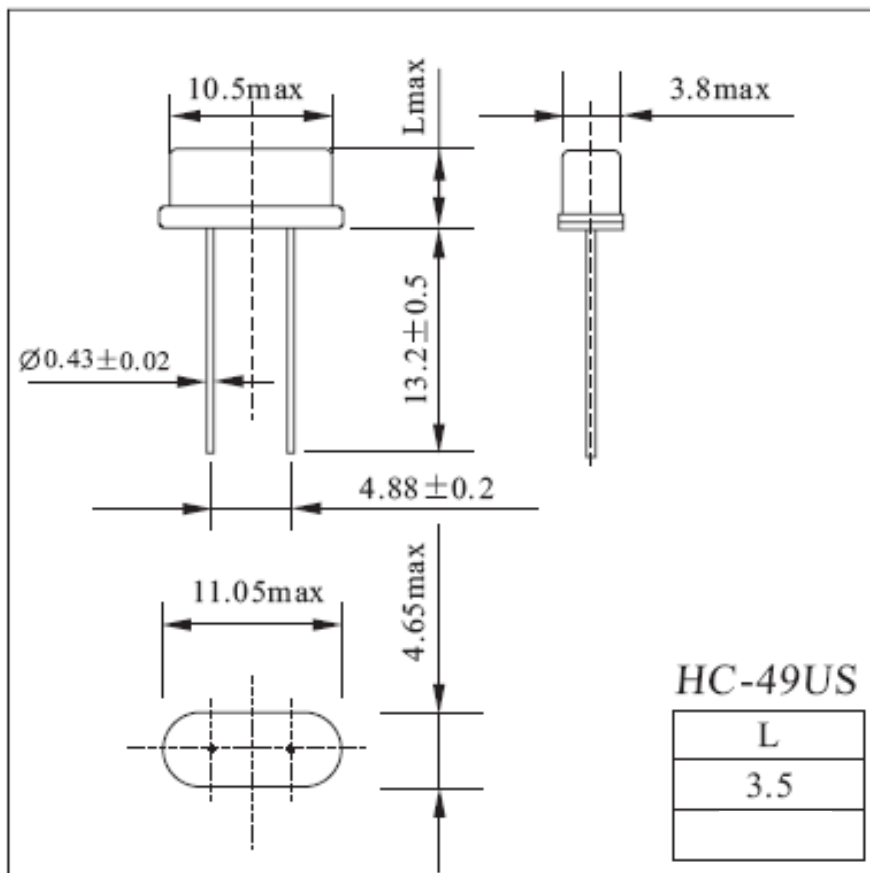

5.回流焊曲线 Reflow Profiles

Profiles Feature	Pb-Free Assembly
Average Ramp-up Rate (Ts max to Tp)	3°C/second max.
Preheat	
Temperature Min (Ts min)	125°C
Temperature Max(Ts max)	200°C
Time (ts min to ts max)	60~180 seconds
Time maintained above	
Temperature (TL)	217°C
Time (tL)	60~150 seconds
Peak/Classification Temperature (Tp)	
Time within 5°C of actual Peak	20~40 second
Temperature(tp)	
Ramp-down rate	6°C/second max.
Time 25°C to Peak Temperature	8 minutes max.
Suggest reflow times	3 times max.

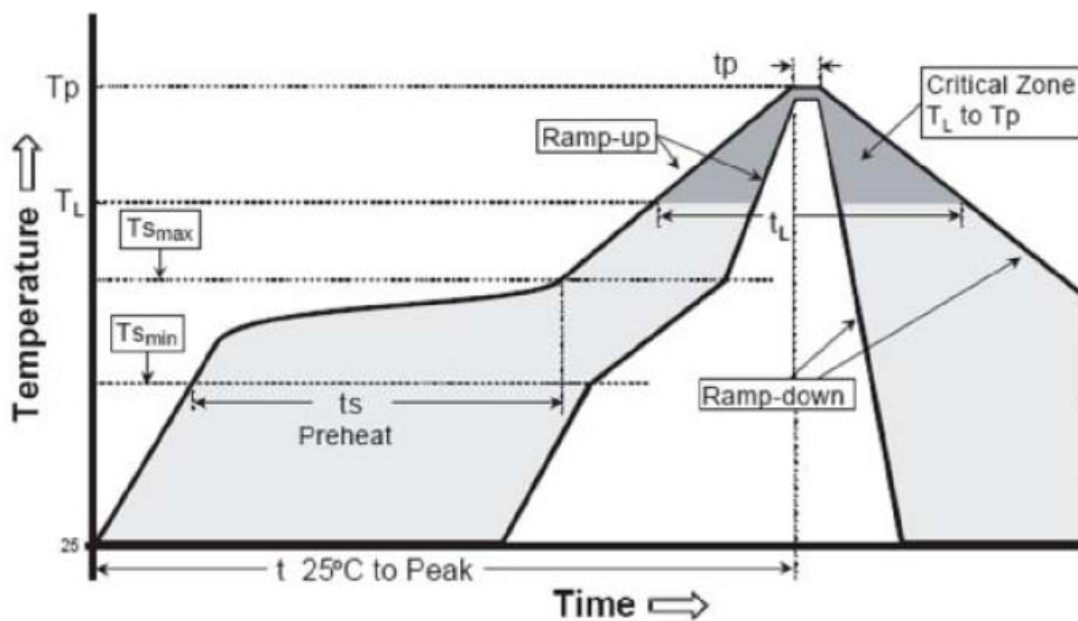

6.机械可靠/信赖性 Mechanical Performance

	Item	Condition	Standard
1.	Drop characteristics	Free drop from 50cm height on a hard wooden board for 3 times. (Board is thickness more than 30 mm.)	Frequency change: ≤5ppm Rr as specification
2..	Shake characteristics	Shake frequency 10~55Hz, cyc1~2 minutes, swing 1.5mm, direction x/y/z, all 30 minutes, test after 1 hours.	Frequency change: ≤5ppm Rr as specification
3.	Airproof characteristics	Put crystal into the pressure cabin with alcohol, keep pressure 0.4~0.5mpa 10 minutes, then take out and blow for 5 minutes	IR≥500MΩ
4.	Weld characteristics	260℃ Max, 10 seconds	90% exhibit tin ok
5.	Humidity characteristics	+40±2℃ & 90%~95% R.H. 250 hours	Frequency change: ≤5ppm Rr as specification
6.	Low temperature characteristics	-30±2℃, 250 hours, put in room temperature, test after 1 hours.	Frequency change: ≤5ppm Rr as specification
7.	High temperature characteristics	+85±2℃, 250 hours, put in room temperature, test after 1 hours.	Frequency change: ≤5ppm Rr as specification
8.	Temperature cycling	-30±3℃/30±3 min~+85±2℃/30±3min, 5 cycles	Frequency change: ≤5ppm Rr as specification

7.Dimension of Inside Package

内包装尺寸图

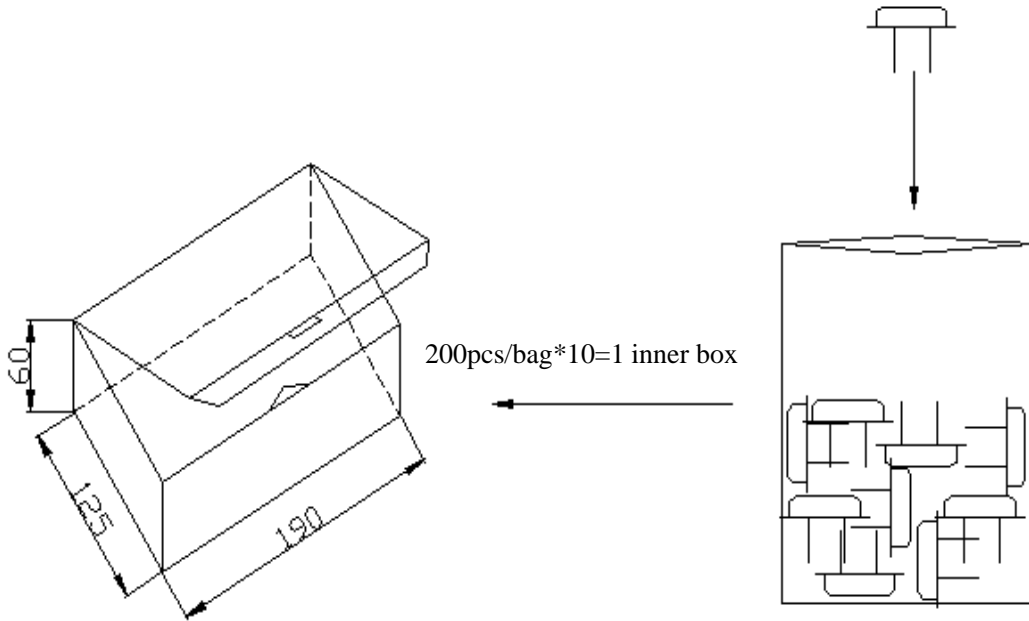

Dimensions of outside Package

外包装尺寸图

