

## MMBD4148 / SE / CC / CA Silicon Epitaxial Planar Switching Diode

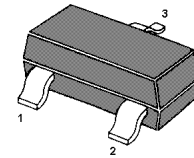
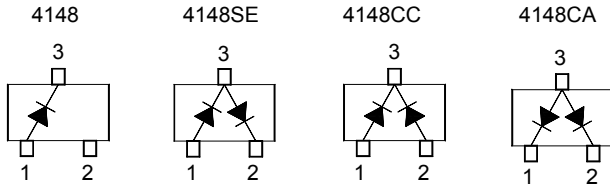

MMBD4148 Marking Code: **5H**  
 MMBD4148SE Marking Code: **D4**  
 MMBD4148CC Marking Code: **D5**  
 MMBD4148CA Marking Code: **D6**  
 SOT-23 Plastic Package

### Absolute Maximum Ratings ( $T_a = 25\text{ }^\circ\text{C}$ )

Parameter	Symbol	Value	Unit
Maximum Repetitive Reverse Voltage	$V_{RRM}$	100	V
Reverse Voltage	$V_R$	75	V
Average Rectified Forward Current	$I_{F(AV)}$	200	mA
DC Forward Current	$I_{FM}$	600	mA
Recurrent Peak Forward Current	$I_{FRM}$	700	mA
Non-repetitive Peak Forward Surge Current	$I_{FSM}$	1 2	A
		at $t = 1\text{ s}$ at $t = 1\text{ }\mu\text{s}$	
Total Device Dissipation	$P_{tot}$	350	mW
Operating Junction Temperature	$T_j$	150	$^\circ\text{C}$
Storage Temperature Range	$T_{stg}$	- 55 to + 150	$^\circ\text{C}$

### Characteristics at $T_a = 25\text{ }^\circ\text{C}$

Parameter	Symbol	Min.	Max.	Unit
Forward Voltage at $I_F = 10\text{ mA}$	$V_F$	-	1	V
Reverse Breakdown Voltage at $I_R = 100\text{ }\mu\text{A}$ at $I_R = 5\text{ }\mu\text{A}$	$V_{(BR)R}$	100 75	- -	V
Reverse Current at $V_R = 20\text{ V}$ at $V_R = 75\text{ V}$ at $V_R = 20\text{ V}, T_a = 150\text{ }^\circ\text{C}$	$I_R$	- - -	25 5 50	nA $\mu\text{A}$ $\mu\text{A}$
Reverse Recovery Time at $I_F = 10\text{ mA}, V_R = 6\text{ V}, I_{RR} = 1\text{ mA}, R_L = 100\text{ }\Omega$	$t_{rr}$	-	4	ns
Total Capacitance at $V_R = 0\text{ V}, f = 1\text{ MHz}$	$C_T$	-	4	pF

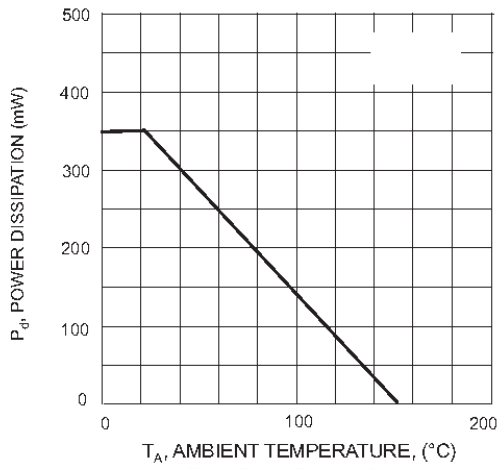

Fig. 1 Power Derating Curve

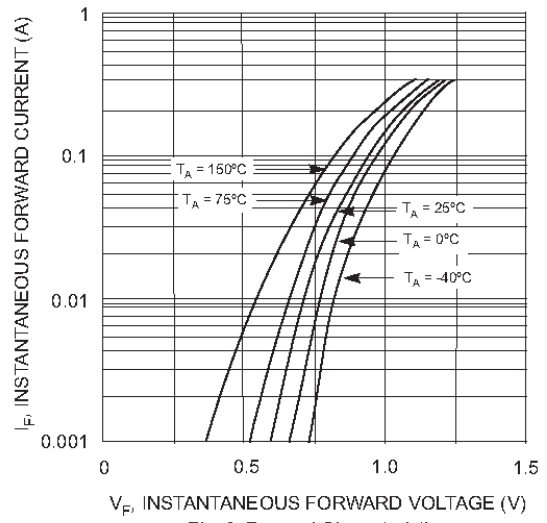

Fig. 2 Forward Characteristics

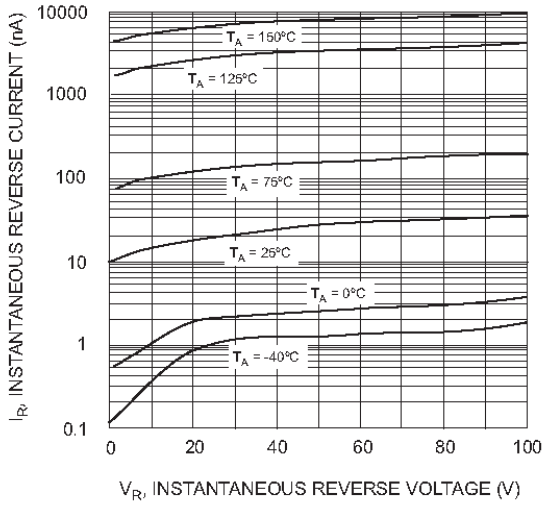

Fig. 3 Typical Reverse Characteristics

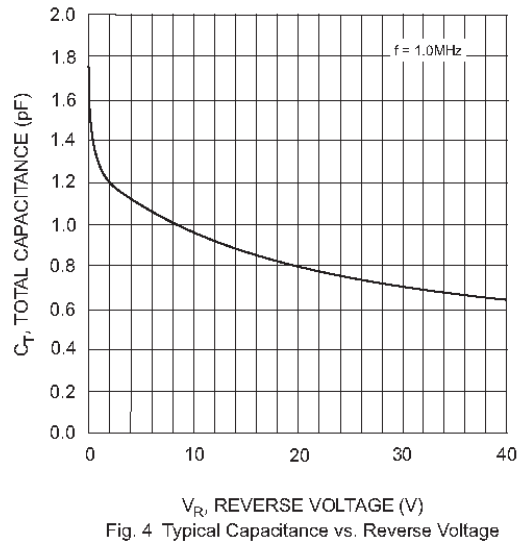

Fig. 4 Typical Capacitance vs. Reverse Voltage



# PACKAGE OUTLINE

Plastic surface mounted package; 3 leads

SOT-23

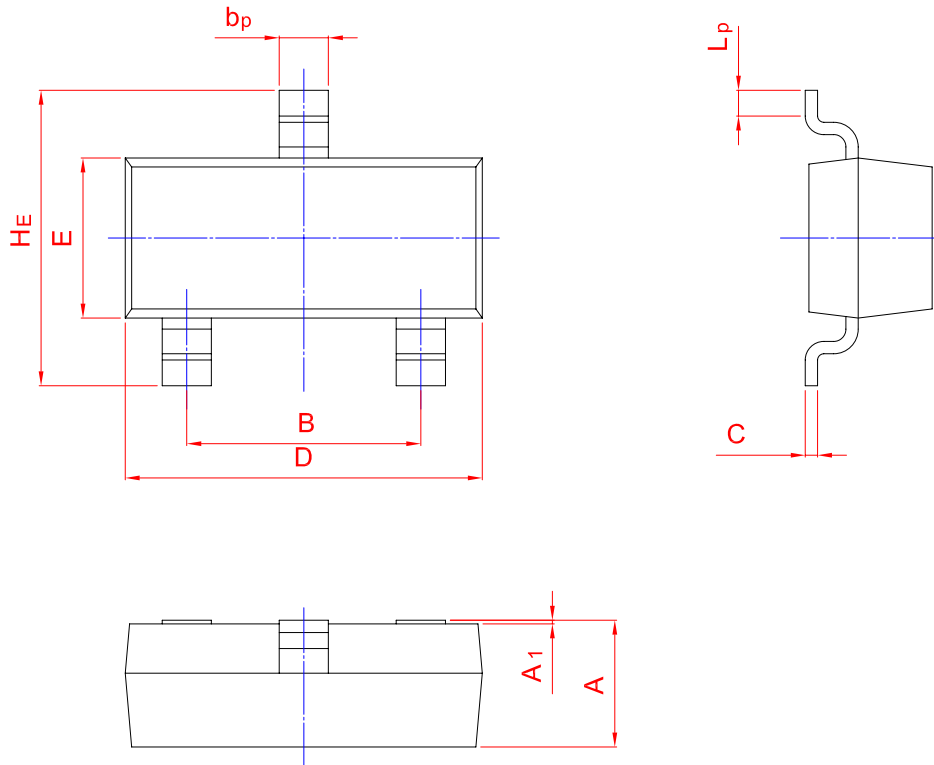
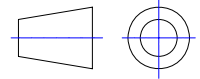

UNIT	A	B	bp	C	D	E	Hε	A1	Lp
mm	1.40	2.04	0.50	0.19	3.10	1.65	3.00	0.100	0.50
	0.95	1.78	0.35	0.08	2.70	1.20	2.20	0.013	0.20