

Description

TVS diodes can be used in a wide range of applications which like consumer electronic products, automotive industries, munitions, telecommunications, aerospace industries, and intelligent control systems.

Features

- Glass passivated or planar junction
- Excellent clamping capability
- Repetition rate (duty cycle): 0.01%
- Low profile package and low inductance
- 600W Peak Pulse power capability at 10×1000μs waveform.
- Fast response time: typically less than 1.0ps from 0V to V_{BR} min.
- High temperature soldering: 260°C/10s at terminals.
- Plastic package has Underwriters Laboratory Flammability 94V-0.
- For surface mounted applications in order to optimize board space.

Dimensions & Symbol (Unit: mm Max)

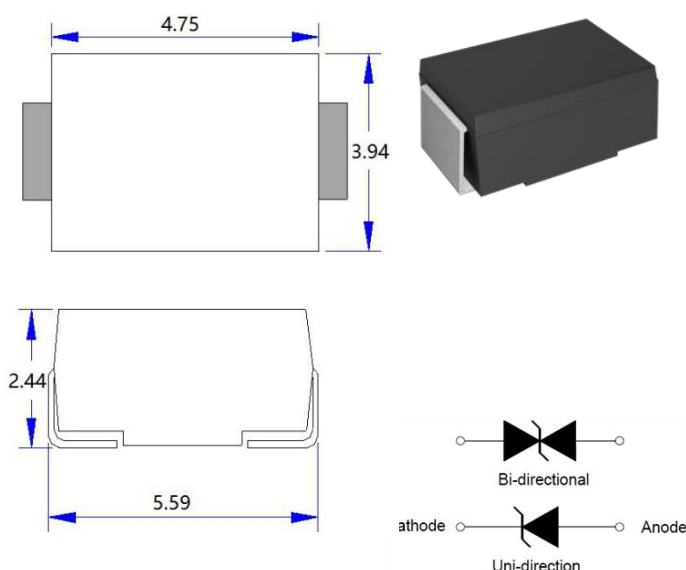

Mechanical Characteristics

Package: SMB/DO-214AA

- Case Material: "Green" Molding Compound.
- UL Flammability Classification Rating 94V-0
- Polarity: Color band denotes cathode except bi-directional models
- Standard Packaging: 12mm tape (EIA STD RS-481)
- Weight: 0.10g
- Terminal Connections: See Diagram Below
- Marking Information: See Below

Applications

- I/O Interface.
- AC/DC Power supply
- Low frequency signal transmission line (RS232, RS485, etc.)

Marking information

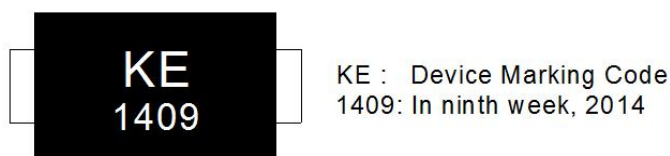

Ordering information

Out line	Reel (pcs)	Per carton (pcs)	Reel diameters (mm)
Taping	3K	48K	330

Electrical characteristics ($T_A=25^\circ\text{C}$)

Part Number		Marking		V_R	$I_R@V_R$	$V_{BR}@I_T$		I_T	$V_C@I_{PP}$	$I_{PP}^{\text{①}}$
Uni-Polar	Bi-Polar	Uni	Bi	V	μA	min(V)	max(V)	mA	max(V)	A
SMBJ3.3A	SMBJ3.3CA	SS	SC	3.3	800	4.10	5.60	10	7.3	82.5
SMBJ5.0A	SMBJ5.0CA	KE	AE	5.0	800	6.40	7.00	10	9.2	65.2
SMBJ6.0A	SMBJ6.0CA	KG	AG	6.0	800	6.67	7.37	10	10.3	58.3
SMBJ6.5A	SMBJ6.5CA	KK	AK	6.5	500	7.22	7.98	10	11.2	53.6
SMBJ7.0A	SMBJ7.0CA	KM	AM	7.0	200	7.78	8.60	10	12.0	50.0
SMBJ7.5A	SMBJ7.5CA	KP	AP	7.5	100	8.33	9.21	1	12.9	46.5
SMBJ8.0A	SMBJ8.0CA	KR	AR	8.0	50	8.89	9.83	1	13.6	44.1
SMBJ8.5A	SMBJ8.5CA	KT	AT	8.5	20	9.44	10.40	1	14.4	41.7
SMBJ9.0A	SMBJ9.0CA	KV	AV	9.0	10	10.00	11.10	1	15.4	39.0
SMBJ10A	SMBJ10CA	KX	AX	10	10	11.10	12.30	1	17.0	35.3
SMBJ11A	SMBJ11CA	KZ	AZ	11	1	12.20	13.50	1	18.2	33.0
SMBJ12A	SMBJ12CA	LE	BE	12	1	13.30	14.70	1	19.9	30.2
SMBJ13A	SMBJ13CA	LG	BG	13	1	14.40	15.90	1	21.5	27.9
SMBJ14A	SMBJ14CA	LK	BK	14	1	15.60	17.20	1	23.2	25.9
SMBJ15A	SMBJ15CA	LM	BM	15	1	16.70	18.50	1	24.4	24.6
SMBJ16A	SMBJ16CA	LP	BP	16	1	17.80	19.70	1	26.0	23.1
SMBJ17A	SMBJ17CA	LR	BR	17	1	18.90	20.90	1	27.6	21.8
SMBJ18A	SMBJ18CA	LT	BT	18	1	20.00	22.10	1	29.2	20.6
SMBJ20A	SMBJ20CA	LV	BV	20	1	22.20	24.50	1	32.4	18.6
SMBJ22A	SMBJ22CA	LX	BX	22	1	24.40	26.90	1	35.5	16.9
SMBJ24A	SMBJ24CA	LZ	BZ	24	1	26.70	29.50	1	38.9	15.4
SMBJ26A	SMBJ26CA	ME	CE	26	1	28.90	31.90	1	42.1	14.3
SMBJ28A	SMBJ28CA	MG	CG	28	1	31.10	34.40	1	45.4	13.2
SMBJ30A	SMBJ30CA	MK	CK	30	1	33.30	36.80	1	48.4	12.4
SMBJ33A	SMBJ33CA	MM	CM	33	1	36.70	40.60	1	53.3	11.3
SMBJ36A	SMBJ36CA	MP	CP	36	1	40.00	44.20	1	58.1	10.4
SMBJ40A	SMBJ40CA	MR	CR	40	1	44.40	49.10	1	64.5	9.3
SMBJ43A	SMBJ43CA	MT	CT	43	1	47.80	52.80	1	69.4	8.7
SMBJ45A	SMBJ45CA	MV	CV	45	1	50.00	55.30	1	72.7	8.3
SMBJ48A	SMBJ48CA	MX	CX	48	1	53.30	58.90	1	77.4	7.8

Electrical characteristics ($T_A=25^{\circ}\text{C}$, continued)

Part Number		Marking		V_R	$I_R@V_R$	$V_{BR}@I_T$		I_T	$V_C@I_{PP}$	$I_{PP}^{\textcircled{1}}$
Uni-Polar	Bi-Polar	Uni	Bi	V	μA	min(V)	max(V)	mA	max(V)	A
SMBJ51A	SMBJ51CA	MZ	CZ	51	1	56.70	62.70	1	82.4	7.3
SMBJ54A	SMBJ54CA	NE	DE	54	1	60.00	66.30	1	87.1	6.9
SMBJ58A	SMBJ58CA	NG	DG	58	1	64.40	71.20	1	93.6	6.4
SMBJ60A	SMBJ60CA	NK	DK	60	1	66.70	73.70	1	96.8	6.2
SMBJ64A	SMBJ64CA	NM	DM	64	1	71.10	78.60	1	103.0	5.8
SMBJ70A	SMBJ70CA	NP	DP	70	1	77.80	86.00	1	113.0	5.3
SMBJ75A	SMBJ75CA	NR	DR	75	1	83.30	92.10	1	121.0	5.0
SMBJ78A	SMBJ78CA	NT	DT	78	1	86.70	95.80	1	126.0	4.8
SMBJ85A	SMBJ85CA	NV	DV	85	1	94.40	104.0	1	137.0	4.4
SMBJ90A	SMBJ90CA	NX	DX	90	1	100.0	111.0	1	146.0	4.1
SMBJ100A	SMBJ100CA	NZ	DZ	100	1	111.0	123.0	1	162.0	3.7
SMBJ110A	SMBJ110CA	PE	EE	110	1	122.0	135.0	1	177.0	3.4
SMBJ120A	SMBJ120CA	PG	EG	120	1	133.0	147.0	1	193.0	3.1
SMBJ130A	SMBJ130CA	PK	EK	130	1	144.0	159.0	1	209.0	2.9
SMBJ150A	SMBJ150CA	PM	EM	150	1	167.0	185.0	1	243.0	2.5
SMBJ160A	SMBJ160CA	PP	EP	160	1	178.0	197.0	1	259.0	2.3
SMBJ170A	SMBJ170CA	PR	ER	170	1	189.0	209.0	1	275.0	2.2
SMBJ180A	SMBJ180CA	PT	ET	180	1	201.0	222.0	1	292.0	2.1
SMBJ190A	SMBJ190CA	PV	EV	190	1	211.0	234.0	1	307.0	2.0
SMBJ200A	SMBJ200CA	PX	EX	200	1	224.0	247.0	1	324.0	1.9
SMBJ210A	SMBJ210CA	PZ	EZ	210	1	233.0	258.0	1	337.0	1.8
SMBJ220A	SMBJ220CA	QE	FE	220	1	246.0	272.0	1	356.0	1.7
SMBJ250A	SMBJ250CA	QG	FG	250	1	279.0	309.0	1	405.0	1.5
SMBJ300A	SMBJ300CA	QK	FK	300	1	335.0	371.0	1	486.0	1.3
SMBJ350A	SMBJ350CA	QM	FM	350	1	391.0	432.0	1	567.0	1.1
SMBJ400A	SMBJ400CA	QP	FP	400	1	447.0	494.0	1	648.0	0.9
SMBJ440A	SMBJ440CA	QR	FR	440	1	492.0	543.0	1	713.0	0.8

① Surge waveform: 10/1000 μs

V_R : Stand-off Voltage -- Maximum voltage that can be applied

V_{BR} : Breakdown Voltage

V_C : Clamping Voltage -- Peak voltage measured across the suppressor at a specified I_{pp}

I_R : Reverse Leakage Current

Part Number Code

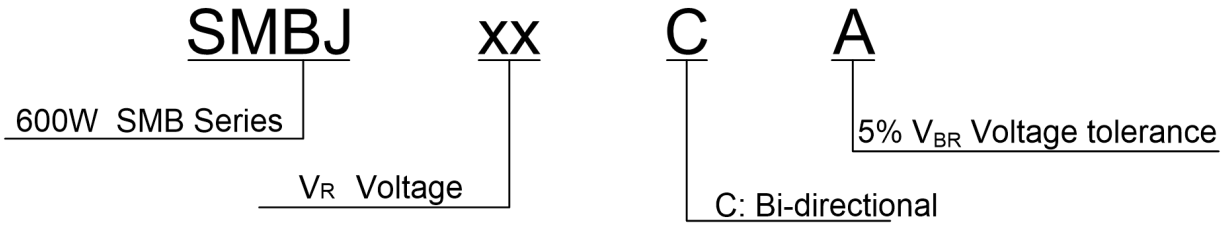

Absolute Maximum Ratings ($T_A=25^\circ\text{C}$, RH=45%-75%, unless otherwise noted)

Parameter	Symbol	Value	Unit
Storage temperature range	T_{stg}	-55 to +150	$^\circ\text{C}$
Operating junction temperature range	T_j	-55 to +150	$^\circ\text{C}$
Steady state power dissipation at $T_L=75^\circ\text{C}$	$P_{M(AV)}$	5.0	W
Peak pulse power dissipation on 10/1000 μs waveform	P_{PP}	600	W
Maximum Instantaneous Forward Voltage at 50A for Unidirectional	V_F	5.0	V

Ratings And V-I Characteristics Curves ($T_A=25^\circ\text{C}$, unless otherwise noted)

FIG.1:V- I curve characteristics (Uni-directional)

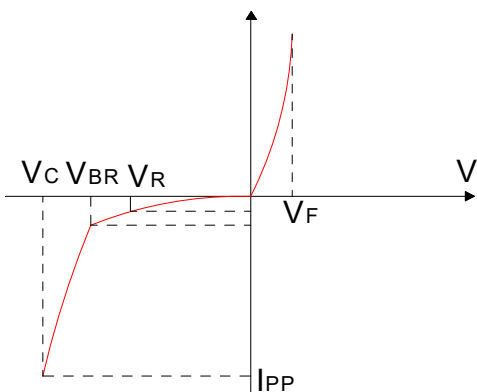

FIG.2:V- I curve characteristics (Bi-directional)

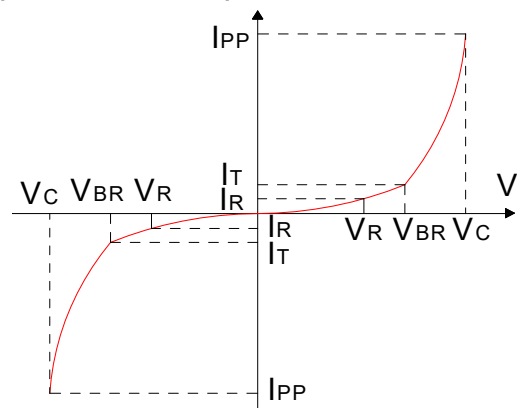

FIG.3: Pulse waveform

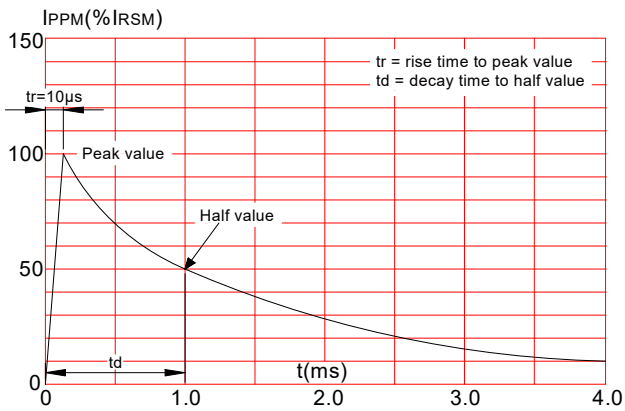
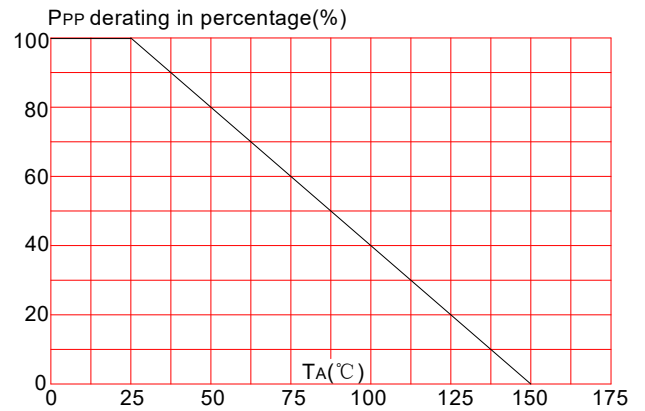
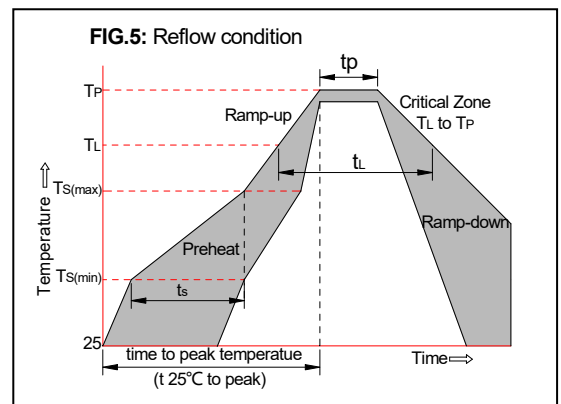

FIG.4: Pulse derating curve



Soldering Parameters

Reflow Condition		Pb-Free assembly (see FIG.5)
Pre Heat	-Temperature Min ($T_{s(min)}$)	+150°C
	-Temperature Max($T_{s(max)}$)	+200°C
	-Time (Min to Max) (t_s)	60-180 secs.
Average ramp up rate (Liquid us Temp (T_L) to peak)		3°C/sec. Max
$T_{s(max)}$ to T_L - Ramp-up Rate		3°C/sec. Max
Reflow	-Temperature(T_L)(Liquid us)	+217°C
	-Temperature(t_L)	60-150 secs.
Peak Temp (T_p)		+260(+0/-5)°C
Time within 5°C of actual Peak Temp (t_p)		30 secs. Max
Ramp-down Rate		6°C/sec. Max
Time 25°C to Peak Temp (T_p)		8 min. Max
Do not exceed		+260°C



Package Mechanical Data

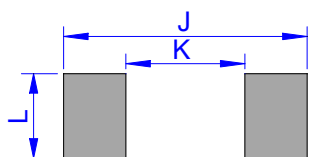
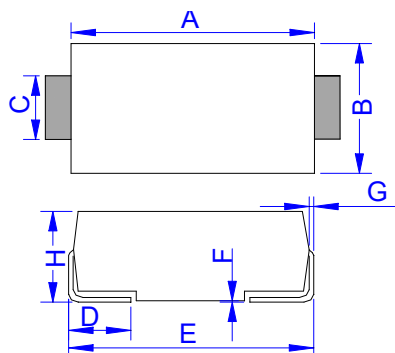

DO-214AA (SMB)

Ref.	Dimensions			
	Millimeters		Inches	
	Min.	Max.	Min.	Max.
A	4.25	4.75	0.167	0.187
B	3.30	3.94	0.130	0.155
C	1.85	2.21	0.073	0.087
D	0.76	1.52	0.030	0.060
E	5.08	5.59	0.200	0.220
F	0.051	0.203	0.002	0.008
G	0.15	0.31	0.006	0.012
H	2.11	2.44	0.083	0.096
J	6.80		0.270	
K		2.60		0.100
L	2.40		0.090	

Tape & Reel Specification - SMB

Ref.	Dimensions	
	Millimeters	Inches
A	3.76 ± 0.2	0.144 ± 0.012
B	5.69 ± 0.2	0.244 ± 0.012
d	1.5 ± 0.25	0.059 ± 0.004
D	330.0	13.0
D2	13 ± 1	0.512 ± 0.039
E	1.75 ± 0.2	0.059 ± 0.008
F	5.5 ± 0.1	0.222 ± 0.008
P	8.0 ± 0.2	0.315 ± 0.008
P0	4.0 ± 0.2	0.157 ± 0.008
P1	2.0 ± 0.2	0.079 ± 0.008
W	12.0 ± 0.3	0.472 ± 0.008
W1	16.8 ± 2.0	0.661 ± 0.079

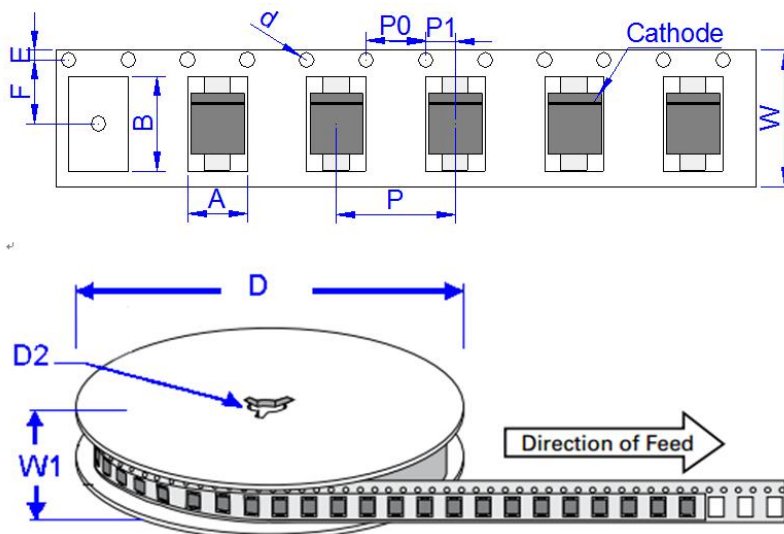

Contact Information

WPMTEK Incorporated Limited

Floor 1 Building 4#, Binxianghua Industry Park, No.7,

Huada Road, Hualian Community, Longhua New District, Shenzhen

TEL: 86755-29308003

FAX: 86755-23739900

wpmtek Incorporated Limited (WPM) reserves the right to make changes to the product specification and data in this document without notice. WPM makes no warranty, representation or guarantee regarding the suitability of its products for any particular purpose, nor does WPM assume any liability arising from the application or use of any products or circuits, and specifically dis-claims any and all liability, including without limitation special, consequential or incidental damages.