



## GLASS PASSIVATED BRIDGE RECTIFIERS

REVERSE VOLTAGE - 50 to 1000 Volts  
FORWARD CURRENT - 3.0 Amperes

### FEATURES

- Rating to 1000V PRV
- Ideal for printed circuit board
- Reliable low cost construction utilizing molded plastic technique
- The plastic material has UL flammability classification 94V#0

### KBP

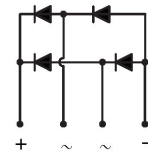
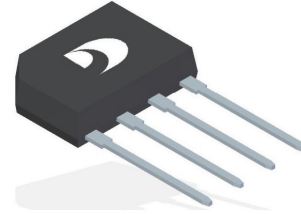

### MECHANICAL DATA

- Polarity : As marked on body
- Weight : 0.05 ounces, 1.52 grams
- Mounting position : Any

### MAXIMUM RATINGS AND ELECTRICAL CHARACTERISTICS

Ratings at 25°C ambient temperature unless otherwise specified.

CHARACTERISTICS	SYMBOL	KBP 3005G	KBP 301G	KBP 302G	KBP 304G	KBP 306G	KBP 308G	KBP 310G	UNIT
Maximum Repetitive Peak Reverse Voltage	$V_{RRM}$	50	100	200	400	600	800	1000	V
Maximum RMS Voltage	$V_{RMS}$	35	70	140	280	420	560	700	V
Maximum DC Blocking Voltage	$V_{DC}$	50	100	200	400	600	800	1000	V
Maximum Average Forward Rectified Current @ $T_C=105^\circ\text{C}$ (With heatsink) (Without heatsink)	$I_{(AV)}$				3.0				A
Peak Forward Surge Current 8.3ms single half sine-wave @ $T_j = 25^\circ\text{C}$	$I_{FSM}$				75				A
Peak Forward Surge Current 1.0ms single half sine-wave @ $T_j = 25^\circ\text{C}$	$I_{FSM}$				150				A
Maximum Forward Voltage at 3.0A DC	$V_F$				1.1				V
Maximum DC Reverse Current at rated Blocking Voltage @ $T_j=25^\circ\text{C}$ @ $T_j=125^\circ\text{C}$	$I_R$				5.0 500				$\mu\text{A}$
$I^2t$ Rating for fusing ( $3\text{ms} \leq t \leq 8.3\text{ms}$ )	$I^2t$				26.5				$\text{A}^2\text{S}$
Typical Junction Capacitance per element (Note 1)	$C_J$				50				pF
Typical thermal resistance (Unit mounted on 30mmx30mmx1mm Copper plate heatsink.)	$R_{\theta JC}$ $R_{\theta JL}$ $R_{\theta JA}$				10 12 30				$^\circ\text{C/W}$
Typical thermal resistance (without heatsink)	$R_{\theta JC}$ $R_{\theta JL}$ $R_{\theta JA}$				12 18 40				$^\circ\text{C/W}$
Operation Temperature Range	$T_J$				-55 to +150				$^\circ\text{C}$
Storage Temperature Range	$T_{STG}$				-55 to +150				$^\circ\text{C}$

Note: (1) Measured at 1.0MHz and applied reverse voltage of 4.0V DC.



FIG.1- FORWARD CURRENT DERATING CURVE

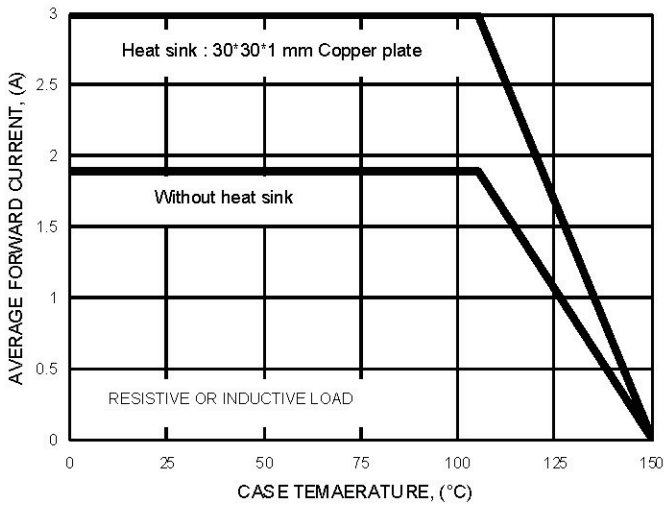

FIG.2- MAXIMUM NON-REPETITIVE SURGE CURRENT

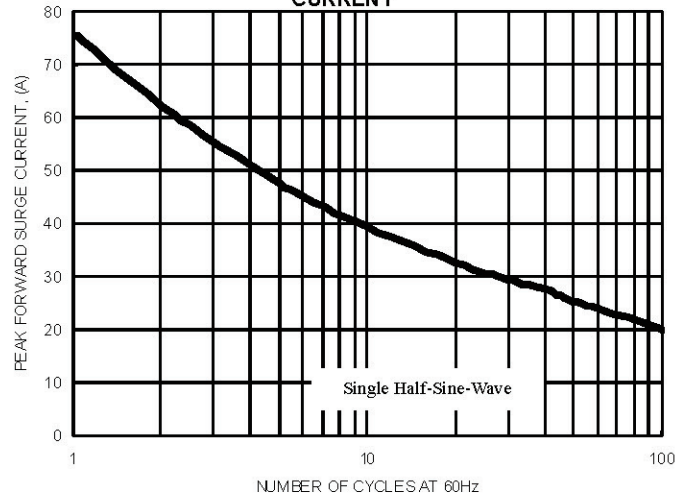

FIG.3- TYPICAL JUNCTION CAPACITANCE

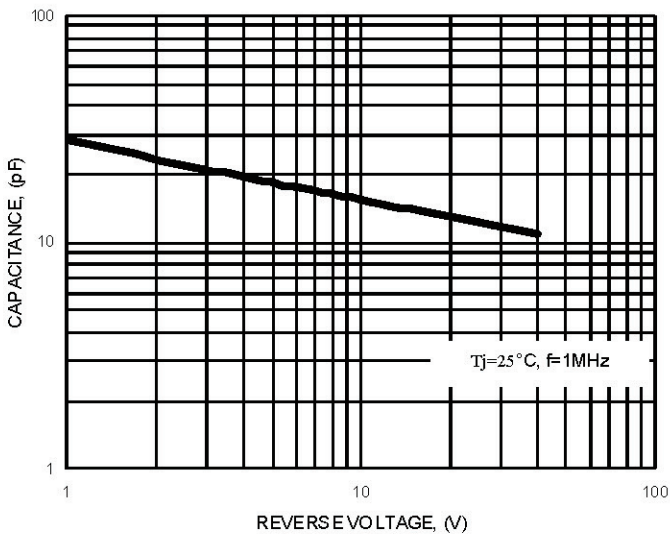

FIG.4- TYPICAL FORWARD CHARACTERISTICS

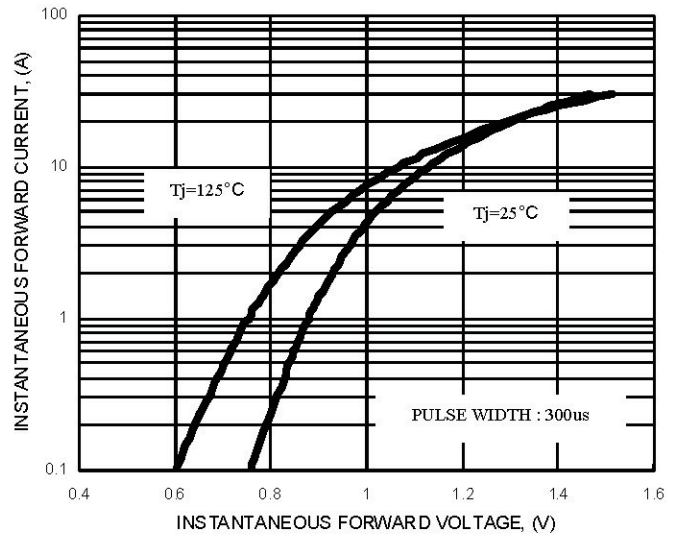
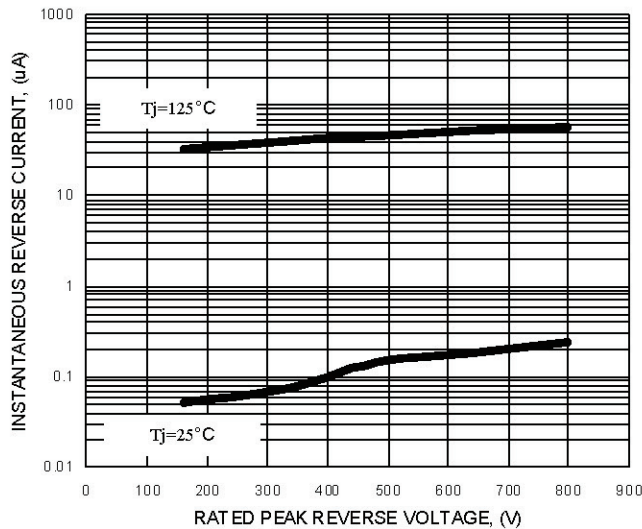
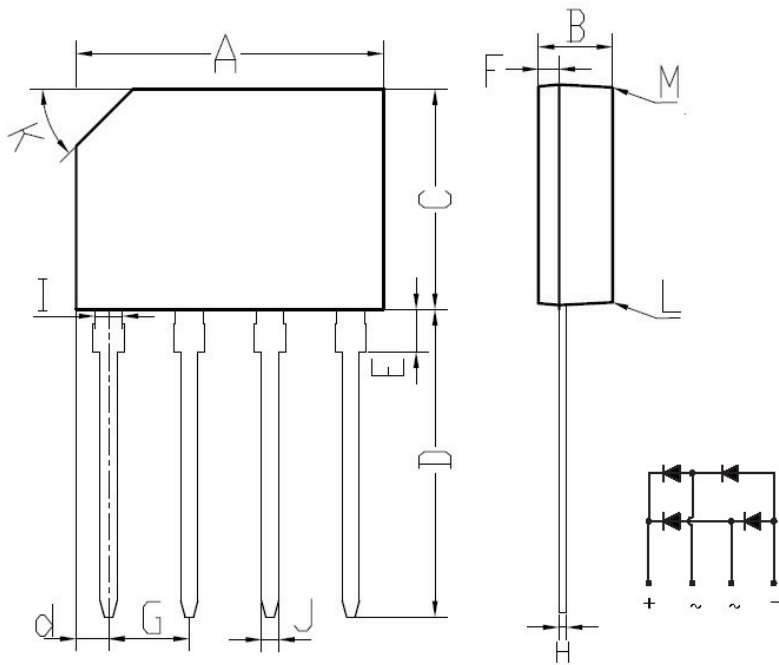

FIG.5- TYPICAL REVERSE CHARACTERISTICS





KBP Package Outline Dimensions



KBP		
DIM.	MIN.	MAX.
A	14.25	14.75
B	3.35	3.65
C	10.20	10.60
D	14.25	14.73
d	1.40	1.70
E	1.80	2.20
F	0.80	1.10
G	3.56	4.06
H	0.35	0.55
I	1.22	1.42
J	0.76	0.86
K	2.7 x 45° (Typ)	
L	#	3°
M	#	2°
All Dimensions in millimeter		