

# FAN6292CMX

## Secondary Side Synchronous Rectifier Controller for Flyback Converters

### Descriptions

The FAN6292CMX is a secondary-side synchronous rectifier (SR) controller for an isolated flyback converter operating in Discontinuous Conduction Mode (DCM). The adaptive dead time control algorithm minimizes the body diode conduction of SR MOSFET while guaranteeing stable and robust SR operation against noise and disturbance caused by the circuit parasitic.

When pair with FAN1080, PSR controller, FAN6292CMX can execute functions that are more valuable. Dynamic Response Enhancement (DRE) awakes primary controller quickly during load transient thus improves voltage dip.

FAN6292C are also source only USB Type-C controllers which are optimized for mobile chargers and power adapters. It supports standard 3 A VBUS current level is compatible as a load switch, and helps to reduce BOM cost.

### Features

- Support Discontinuous Conduction Modes (DCM) and Boundary Conduction Mode (BCM)
- Adaptive Turn-Off Dead Time Tuning for General SR MOSFET Application
- Turn-On Trigger Blanking Time (Minimum Gate OFF Time) for Improved Noise Immunity
- Dynamic Response Enhancement (DRE) Function to Improve System Dynamic Response
- Type-C Control for Standard 3 A VBUS Current Level
- N-Channel MOSFET Control as a Load Switch for USB Type-C
- Minimum Turn-On Delay (20 ns)
- Supporting General Output Voltage (VIN) Range : 3.25 V ~ 20 V for LDO Input
- Fewest External Component Allowed

### Applications

- Travel Adapter for Smart Phones, Feature Phones and Tablet PCs
- AC-DC Adapters for Portable Devices that Require CV/CC Control
- IoT Power Applications



ON Semiconductor®

[www.onsemi.com](http://www.onsemi.com)



SOIC8  
CASE 751EB

### MARKING DIAGRAM

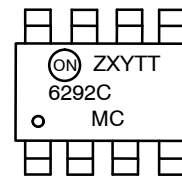

|       |                       |
|-------|-----------------------|
| Z     | = Assembly Plant Code |
| X     | = Year Code           |
| Y     | = Week Code           |
| TT    | = Die Run Code        |
| 6292C | = FAN6292C            |
| M     | = SOP                 |
| C     | = Manufacture Code    |

### PIN CONNECTIONS

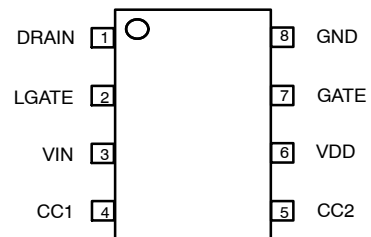

### ORDERING INFORMATION

See detailed ordering and shipping information on page 2 of this data sheet.

# FAN6292CMX

## PACKAGE MARKING AND ORDERING INFORMATION

| Part Number | Operating Temperature | Package                | Packing Method   |
|-------------|-----------------------|------------------------|------------------|
| FAN6292CMX  | -40 to 85°C           | 8-Lead, SOIC (Pb-Free) | 2500/Tape & Reel |

†For information on tape and reel specifications, including part orientation and tape sizes, please refer to our Tape and Reel Packaging Specifications Brochure, BRD8011/D.

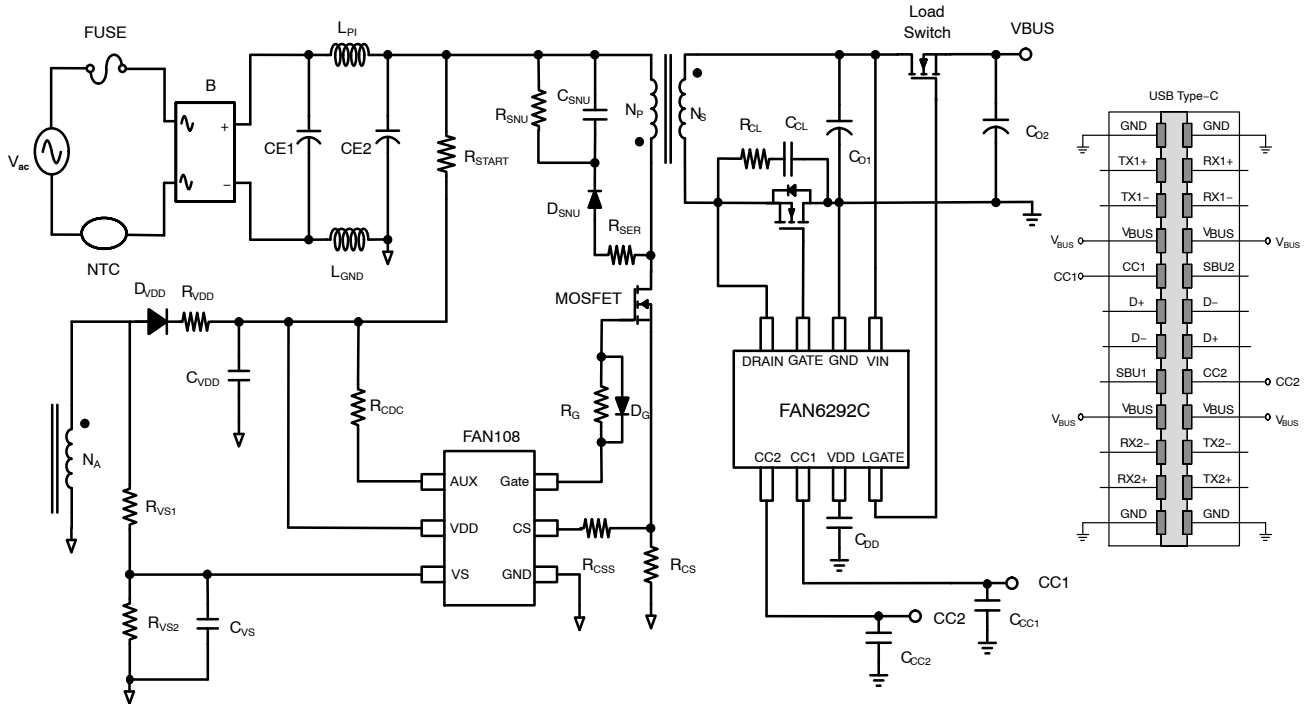

Figure 1. FAN6292C Typical Application Schematic

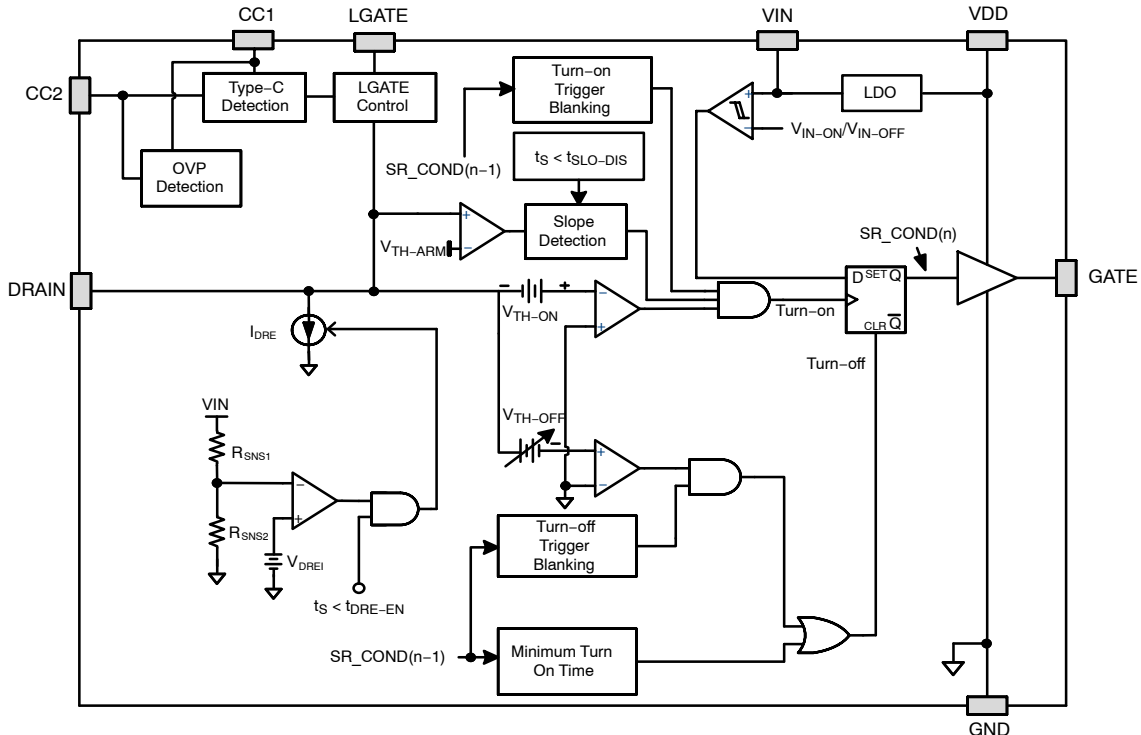

Figure 2. FAN6292C Function Block Diagram

# FAN6292CMX

**Table 1. PIN FUNCTION DESCRIPTION**

| Pin # | Name  | Description   |
|-------|-------|---|
| 1     | DRAIN | <b>Synchronous rectifier drain sense input.</b>   |
| 2     | LGATE | <b>Load switch controlling.</b>   |
| 3     | VIN   | <b>Input voltage pin.</b> This pin is connected to the output of the adaptor to monitor its output voltage and supply internal bias. IC operating current, and MOSFET gate drive current are supplied through this pin. |
| 4     | CC1   | <b>Configuration Channel 1.</b> This pin is used to detect connections of Type-C cables and connectors. It is tied to the USB-C CC1.  |
| 5     | CC2   | <b>Configuration Channel 2.</b> This pin is used to detect connections of Type-C cables and connectors. It is tied to the USB-C CC2.  |
| 6     | VDD   | <b>Internal regulator 5 V output</b> and gate drive power supply rail. Bypass with 1uF capacitor to GND.  |
| 7     | GATE  | <b>Gate driver output.</b>  |
| 8     | GND   | <b>Ground.</b>  |

**Table 2. ABSOLUTE MAXIMUM RATINGS**

| Symbol             | Parameter   | Value       | Unit |
|--------------------|---|-------------|------|
| V <sub>IN</sub>    | Power Supply Pin Voltage  | -0.3 to 20  | V    |
| V <sub>DRAIN</sub> | Drain Sense Pin Voltage   | -1 to 65    | V    |
| V <sub>LGATE</sub> | LGATE PIN Voltage   | -0.3 to 20  | V    |
| V <sub>DD</sub>    | Internal Regulator Pin Voltage                                  | -0.3 to 6.5 | V    |
| V <sub>GATE</sub>  | Gate Pin Voltage  | -0.3 to 6.5 | V    |
| V <sub>CC1</sub>   | CC1 Pin Input Voltage   | -0.3 to 6.0 | V    |
| V <sub>CC2</sub>   | CC2 Pin Input Voltage   | -0.3 to 6.0 | V    |
| P <sub>D</sub>     | Power Dissipation (T <sub>A</sub> = 25°C)                       | 0.651       | W    |
| T <sub>J</sub>     | Operation Junction Temperature                                  | -40 to 125  | °C   |
| T <sub>STG</sub>   | Storage Temperature Range                                       | -60 to 150  | °C   |
| T <sub>L</sub>     | Lead Temperature (Soldering) 10 Seconds                         | 260         | °C   |
| ESD                | Electrostatic Discharge Capability – Charged Device Model (CDM) | 0.5         | kV   |
|                    | Electrostatic Discharge Capability – Human Body Model (HBM)     | 2           |      |

Stresses exceeding those listed in the Maximum Ratings table may damage the device. If any of these limits are exceeded, device functionality should not be assumed, damage may occur and reliability may be affected.

1. All voltage values, except differential voltages, are given with respect to the GND pin.
2. Stresses beyond those listed under Absolute Maximum Ratings may cause permanent damage to the device.
3. Meets JEDEC standards JS-001-2012 and JESD 22-C101.

**Table 3. THERMAL CHARACTERISTICS**

| Symbol          | Parameter                             | Min   | Unit |
|-----------------|---------------------------------------|-------|------|
| θ <sub>JA</sub> | Junction-to-Ambient Thermal Impedance | 150.9 | °C/W |
| θ <sub>JT</sub> | Junction-to-Top Thermal Impedance     | 13.4  | °C/W |

4. T<sub>A</sub> = 25°C unless otherwise specified.

**Table 4. RECOMMENDED OPERATING RANGES**

| Symbol             | Parameter         | Min | Max  | Unit |
|--------------------|-------------------|-----|------|------|
| V <sub>DRAIN</sub> | Drain Pin Voltage | -1  | 60   | V    |
| V <sub>IN</sub>    | VIN Pin Voltage   | 3.5 | 20   | V    |
| V <sub>LGATE</sub> | LGATE Pin Voltage | 0   | 19.5 | V    |
| V <sub>GATE</sub>  | GATE Pin Voltage  | 0   | 5.5  | V    |

# FAN6292CMX

**Table 4. RECOMMENDED OPERATING RANGES** (continued)

| Symbol                           | Parameter           | Min | Max | Unit |
|----------------------------------|---------------------|-----|-----|------|
| V <sub>DD</sub>                  | VDD Pin Voltage     | 3.1 | 5.5 | V    |
| V <sub>CC1/V<sub>CC2</sub></sub> | CC1/CC2 Pin Voltage | 0   | 5.8 | V    |

Functional operation above the stresses listed in the Recommended Operating Ranges is not implied. Extended exposure to stresses beyond the Recommended Operating Ranges limits may affect device reliability.

**Table 5. ELECTRICAL CHARACTERISTICS**

V<sub>IN</sub> = 5.5 V and T<sub>A</sub> = -40°C to 125°C unless otherwise noted.

| Symbol | Parameter | Test Conditions | Min | Typ | Max | Unit |
|--------|-----------|-----------------|-----|-----|-----|------|
|--------|-----------|-----------------|-----|-----|-----|------|

**VDD SECTION**

|                     |                    |  |      |      |      |    |
|---------------------|--------------------|--|------|------|------|----|
| V <sub>IN-ON</sub>  | Turn-On Threshold  | V <sub>IN</sub> rising   | 3.06 | 3.15 | 3.25 | V  |
| V <sub>IN-OFF</sub> | Turn-Off Threshold | V <sub>IN</sub> falling  | 2.78 | 2.9  | 3.05 | V  |
| I <sub>IN-OP</sub>  | Operating Current  | f <sub>SW</sub> = 100 kHz, C <sub>GATE</sub> = 3.3 nF, V <sub>IN</sub> = 5 V |      | 2.5  | 3.2  | mA |

**POWER SUPPLY SECTION**

|                 |                             |   |     |      |     |   |
|-----------------|-----------------------------|---|-----|------|-----|---|
| V <sub>DD</sub> | Internal LDO Output Voltage | V <sub>IN</sub> = 20 V                            | 5.0 | 5.25 | 5.5 | V |
| V <sub>DO</sub> | Dropout Voltage of LDO      | I <sub>OUT</sub> = 10 mA, V <sub>IN</sub> = 3.3 V |     |      | 0.3 | V |

**DRAIN VOLTAGE SENSING SECTION**

|                      |  |   |      |      |      |    |
|----------------------|--|---|------|------|------|----|
| V <sub>OSI</sub>     | Comparator Input Offset Voltage (Note 5)             | Internal Design Suggestion  | -1   | 0    | 1    | mV |
| V <sub>TH-ON</sub>   | Turn-On Threshold Voltage                            | R <sub>DRAIN</sub> = 0 Ω (includes comparator input offset voltage)       | -250 | -200 | -150 | mV |
| t <sub>SLO-DIS</sub> | Slope Detection Disable Criteria (Note 7)            |   | 53   | 58   | 63   | μs |
| t <sub>SLO-HYS</sub> | Slope Detection Disable Criteria Hysteresis (Note 5) |   |      | 8    |      | μs |
| t <sub>ON-DLY</sub>  | Turn On Delay (Note 5)                               | With 50 mV overdrive<br>From V <sub>TH-ON</sub> to Gate voltage over 1 V  |      | 20   |      | ns |
| V <sub>TH-OFF</sub>  | Turn-Off Threshold Tuning Range                      |   | -5   |      | 5    | mV |
| t <sub>OFF-DLY</sub> | Comparator Delay for V <sub>TH-OFF</sub> (Note 5)    | With 0 mV overdrive<br>From V <sub>TH-OFF</sub> to Gate voltage equal 1 V |      | 20   |      | ns |
| V <sub>TH-ARM</sub>  | Gate Re-arming Threshold                             | V <sub>IN</sub> = 5 V (typically 0.7 V <sub>DD</sub> )                    | 3.3  | 3.5  | 3.7  | V  |
| t <sub>ARM</sub>     | Gate Re-arming Time for Slope Detection (Note 5)     |   | 70   | 85   | 100  | ns |
| V <sub>TH-HGH</sub>  | Slope Detection High Threshold (Note 5)              |   | 0.4  | 0.5  | 0.6  | V  |

**MINIMUM ON-TIME AND MINIMUM OFF-TIME SECTION**

|                        |  |   |      |      |      |        |
|------------------------|--|---|------|------|------|--------|
| t <sub>ON-MIN</sub>    | Minimum On-Time                                | t <sub>S</sub> < (t <sub>SLO-DIS</sub> - t <sub>SLO-HYS</sub> ) | 2.16 | 2.4  | 2.64 | μs     |
| t <sub>ON-MIN-L</sub>  | Minimum On-Time at Light Load                  | t <sub>S</sub> ≥ t <sub>SLO-DIS</sub>                           | 1.50 | 1.65 | 1.80 | μs     |
| N <sub>ON-MIN-ST</sub> | Minimum t <sub>ON</sub> Cycles during Start-up |   |      | 3    |      | Cycles |
| t <sub>OFF-MIN-L</sub> | Minimum Off-Time (Note 6)                      | t <sub>S</sub> < (t <sub>SLO-DIS</sub> - t <sub>SLO-HYS</sub> ) | 1.53 | 1.70 | 1.87 | μs     |
| t <sub>OFF-MIN-H</sub> | Minimum On-Time at Light Load (Note 6)         | t <sub>S</sub> ≥ t <sub>SLO-DIS</sub>                           | 3.6  | 4    | 4.4  | μs     |

**DEAD TIME CONTROL SECTION**

|                   |                                       |  |     |     |     |    |
|-------------------|---------------------------------------|--|-----|-----|-----|----|
| t <sub>DEAD</sub> | Dead Time Self-Tuning Target (Note 5) | From GATE OFF to V <sub>DRAIN</sub> rising above 0.5 V | 170 | 200 | 230 | ns |
|-------------------|---------------------------------------|--|-----|-----|-----|----|

# FAN6292CMX

**Table 5. ELECTRICAL CHARACTERISTICS** (continued)

$V_{IN} = 5.5\text{ V}$  and  $T_A = -40^\circ\text{C}$  to  $125^\circ\text{C}$  unless otherwise noted.

| Symbol                   | Parameter                                     | Test Conditions  | Min  | Typ  | Max  | Unit             |
|--------------------------|---|--|------|------|------|------------------|
| <b>TYPE-C SECTION</b>    |   |  |      |      |      |                  |
| $V_{LGATE-ON}$           | Drain Pin Threshold Voltage for LGATE Turn On |  | 6.8  | 7.5  | 8.2  | V                |
| $I_{P-CC1}$              | Source Current on CC1 Pin                     | $V_{IN} = 5\text{ V}, V_{CC1} = 0\text{ V}$                        | 304  | 330  | 356  | $\mu\text{A}$    |
| $I_{P-CC2}$              | Source Current on CC2 Pin                     | $V_{IN} = 5\text{ V}, V_{CC2} = 0\text{ V}$                        | 304  | 330  | 356  | $\mu\text{A}$    |
| $Z_{OPEN-CC1}$           | Input Impedance on CC1 Pin                    |  | 126  |      |      | $\text{k}\Omega$ |
| $Z_{OPEN-CC2}$           | Input Impedance on CC2 Pin                    |  | 126  |      |      | $\text{k}\Omega$ |
| $V_{RA-CC1}$             | Ra Impedance Detection Threshold on CC1 Pin   | $V_{IN} = 5\text{ V}, V_{CC2} = 0\text{ V}$ , decreasing $V_{CC1}$ | 0.75 | 0.80 | 0.85 | V                |
| $V_{RA-CC2}$             | Ra Impedance Detection Threshold on CC2 Pin   | $V_{IN} = 5\text{ V}, V_{CC1} = 0\text{ V}$ , decreasing $V_{CC2}$ | 0.75 | 0.80 | 0.85 | V                |
| $V_{RD-CC1}$             | Rd Impedance Detection Threshold on CC1 Pin   | $V_{IN} = 5\text{ V}, V_{CC2} = 0\text{ V}$ , increasing $V_{CC1}$ | 2.45 | 2.60 | 2.75 | V                |
| $V_{RD-CC2}$             | Rd Impedance Detection Threshold on CC2 Pin   | $V_{IN} = 5\text{ V}, V_{CC1} = 0\text{ V}$ , increasing $V_{CC2}$ | 2.45 | 2.60 | 2.75 | V                |
| $t_{CC-Detach-Debounce}$ | UFP Detachment Debounce Time                  | $V_{IN} = 5\text{ V}, V_{CC2} = 0\text{ V}$ , decreasing $V_{CC1}$ | 10   | 15   | 20   | ms               |
| $t_{CC-Attach-Debounce}$ | UFP Attachment Debounce Time                  | $V_{IN} = 5\text{ V}, V_{CC2} = 0\text{ V}$ , increasing $V_{CC1}$ | 100  | 150  | 200  | ms               |
| $V_{INGATE}$             | LGATE High Voltage for Load Switch Control    | $V_{IN} = 5\text{ V}$  | 8    |      | 11   | V                |

## DRE SECTION

|              |   |  |      |      |      |               |
|--------------|---|--|------|------|------|---------------|
| $V_{DRE}$    | VIN Pin DRE Function Trigger Level (Note 6) | $V_{IN} = 5.5\text{ V} \rightarrow 4.5\text{ V}$           | 4.68 | 4.78 | 4.85 | V             |
| $t_{DREI}$   | DRE Current Sinking Period (Note 5)         | $V_{IN} = 5.5\text{ V} \rightarrow 4.5\text{ V}$           | 1.2  | 1.5  | 1.8  | $\mu\text{s}$ |
| $t_{DRE-EN}$ | DRE Enable Period                           | $V_{IN} = 5.5\text{ V} \rightarrow 4.5\text{ V}$           | 64   | 72   | 80   | $\mu\text{s}$ |
| $t_{RE-ARM}$ | DRE Re-arm Period                           | $V_{IN} = 5.5\text{ V} \rightarrow 4.5\text{ V}$           |      | 4    |      | $\mu\text{s}$ |
| $I_{DRE}$    | DRE Sinking Current                         | Maximum $I_{DRE}$ cycle are 14 every gate switching cycles | 50   |      |      | mA            |

## OUTPUT DRIVER SECTION

|          |                   |   |     |  |      |    |
|----------|-------------------|---|-----|--|------|----|
| $V_{OL}$ | Gate Low Voltage  | $V_{IN} = 6\text{ V}$   |     |  | 0.25 | V  |
| $V_{OH}$ | Gate High Voltage | $V_{IN} = 6\text{ V}$   | 4.9 |  |      | V  |
| $t_R$    | Gate Rise Time    | $V_{IN} = 6\text{ V}, C_L = 3300\text{ pF}$ ,<br>GATE = 1 V $\rightarrow$ 4 V |     |  | 90   | ns |
| $t_F$    | Gate Fall Time    | $V_{IN} = 6\text{ V}, C_L = 3300\text{ pF}$ ,<br>GATE = 4 V $\rightarrow$ 1 V |     |  | 30   | ns |

Product parametric performance is indicated in the Electrical Characteristics for the listed test conditions, unless otherwise noted. Product performance may not be indicated by the Electrical Characteristics if operated under different conditions.

5. Guaranteed by Design.

6. Specification operation temperature range  $-5^\circ\text{C}$  to  $85^\circ\text{C}$ .

7. Specification operation temperature range  $-5^\circ\text{C}$  to  $50^\circ\text{C}$ .

TYPICAL PERFORMANCE CHARACTERISTICS

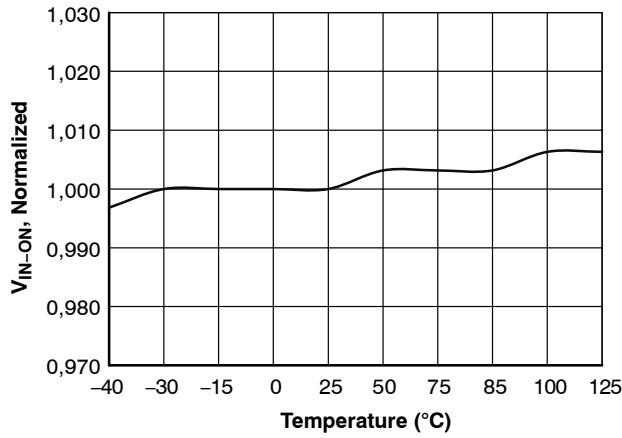

Figure 3. Turn-On Threshold Voltage ( $V_{IN-ON}$ ) vs. Temperature

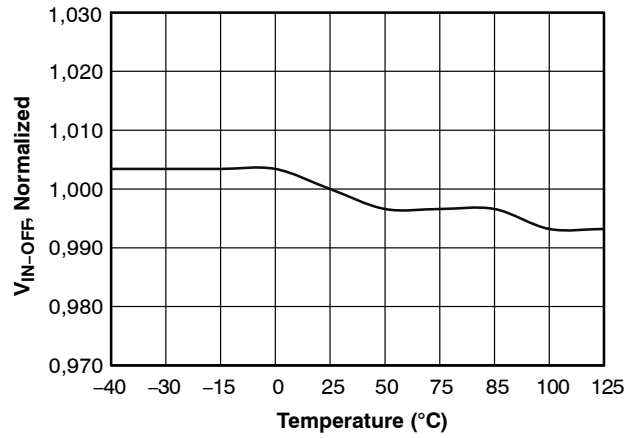

Figure 4. Turn-Off Threshold Voltage ( $V_{IN-OFF}$ ) vs. Temperature

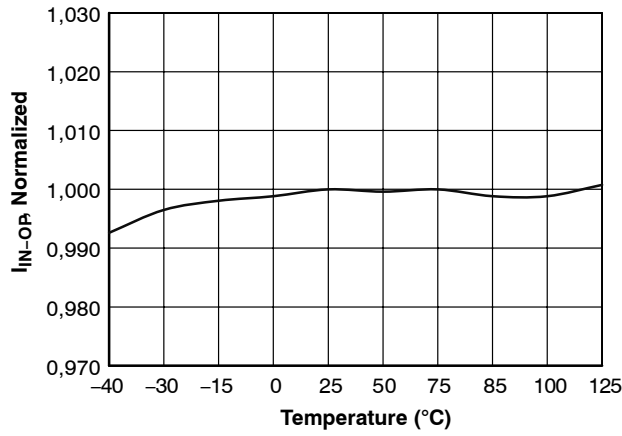

Figure 5. Operating Supply Current ( $I_{IN-OP}$ ) vs. Temperature

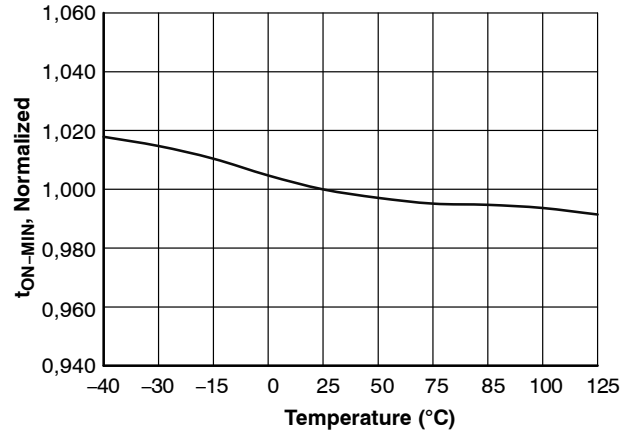

Figure 6. Minimum On Time ( $t_{ON-MIN}$ ) vs. Temperature

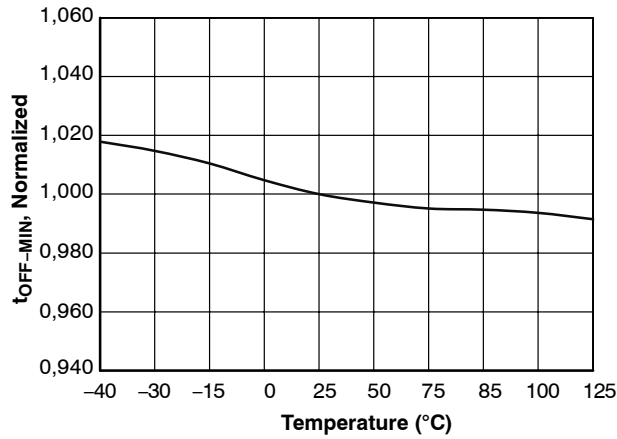

Figure 7. Minimum Gate Turn Off Time ( $t_{OFF-MIN}$ ) vs. Temperature

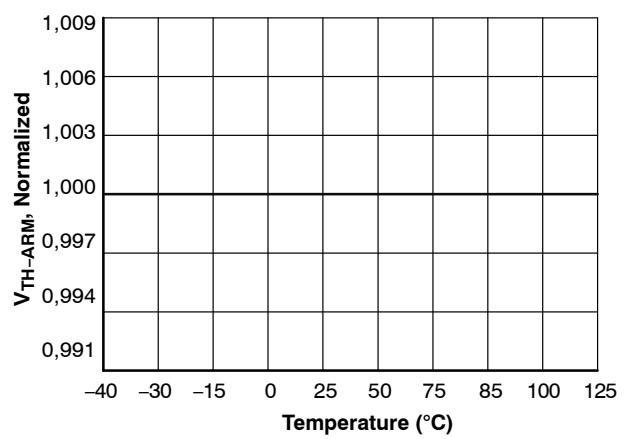

Figure 8. Gate Turn On Threshold Voltage ( $V_{TH-ARM}$ ) vs. Temperature

TYPICAL PERFORMANCE CHARACTERISTICS (continued)

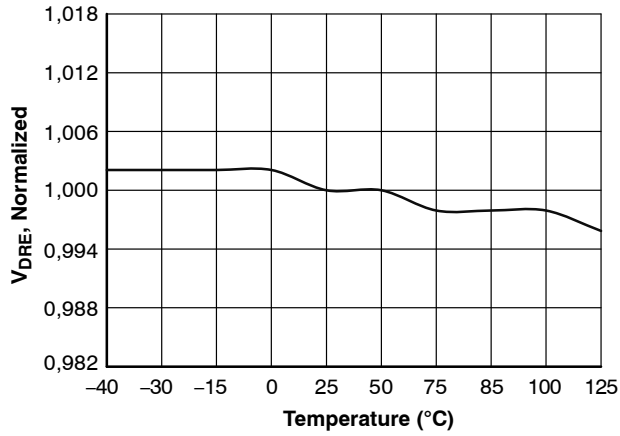

Figure 9. VIN Pin DRE Function Trigger Level ( $V_{DRE}$ ) vs. Temperature

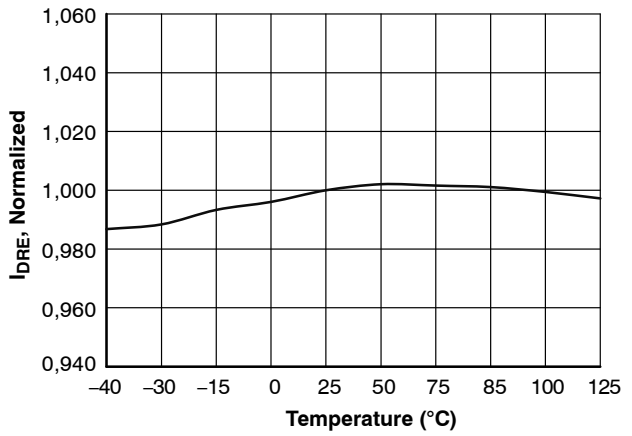

Figure 10. Drain Pin Sinking Current for DRE Triggered ( $I_{DRE}$ ) vs. Temperature

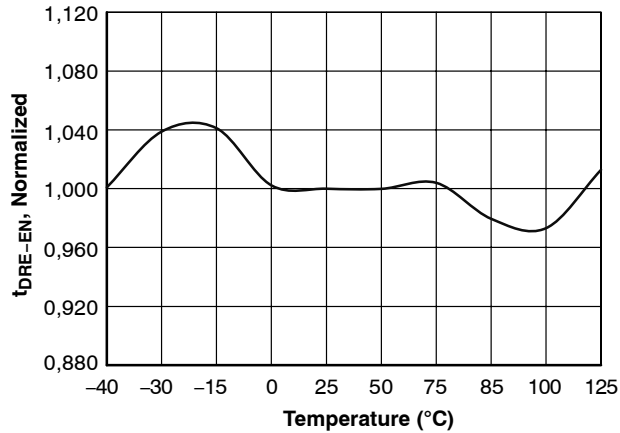

Figure 11. DRE Function Enable Period ( $t_{DRE-EN}$ ) vs. Temperature

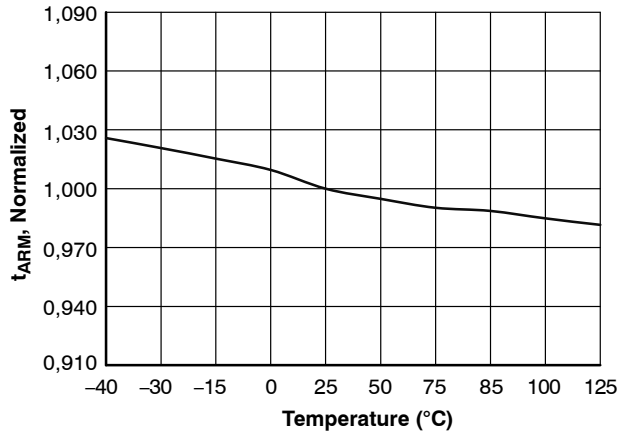

Figure 12. Gate Re-Arming Time for Slope Detection ( $t_{ARM}$ ) vs. Temperature

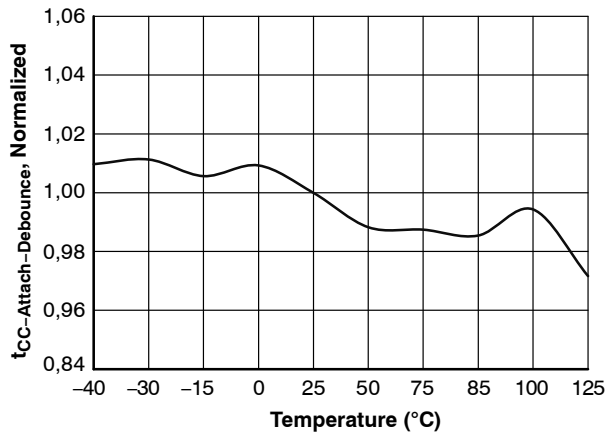

Figure 13. UFP Attachment Debounce Time ( $t_{CC-Attach-Debounce}$ ) vs. Temperature

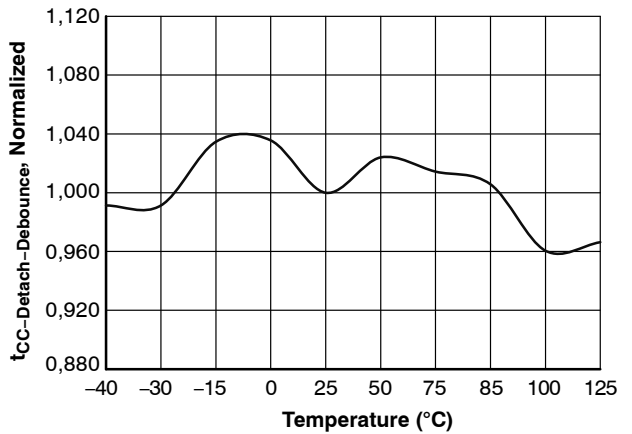

Figure 14. UFP Detachment Debounce Time ( $t_{CC-Detach-Debounce}$ ) vs. Temperature

TYPICAL PERFORMANCE CHARACTERISTICS (continued)

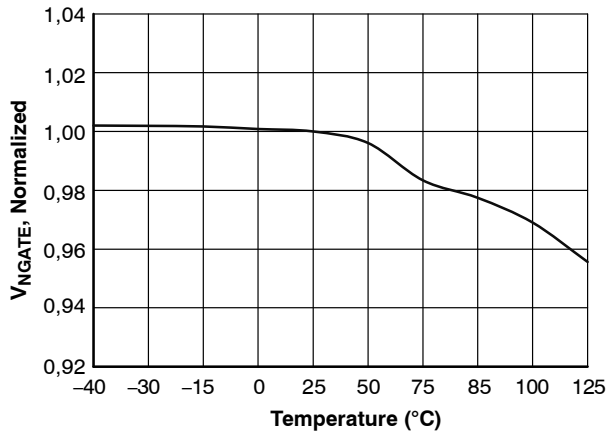

Figure 15. LGATE High Level Voltage (V<sub>NGATE</sub>) vs. Temperature

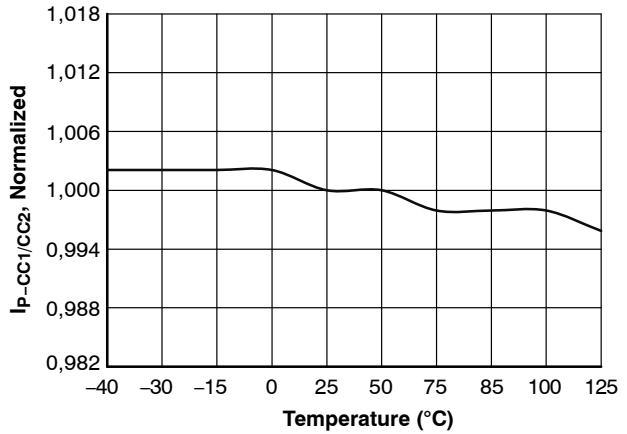

Figure 16. Source Current on CC1/CC2 Pin (I<sub>P-CC1/CC2</sub>) vs. Temperature

FUNCTIONAL DESCRIPTION

Overview

For an ideal circuit operation, the SR control algorithm of FAN6292C is very straightforward. FAN6292C controls the SR MOSFET based on the instantaneous Drain-to-Source voltage as illustrated in Figure 17. When the body diode starts conducting, the drain-to-source voltage drops below the turn-on threshold (V<sub>TH-ON</sub>) which triggers the turn-on of the gate. Then the product of R<sub>DS-ON</sub> and instantaneous SR current determines the Drain-to-Source voltage. When the drain-to-source voltage reaches the turn-off threshold (V<sub>TH-OFF</sub>) as SR MOSFET current decreases to near zero, FAN6292C turns off the gate. If the turn off threshold (V<sub>TH-OFF</sub>) is very close to zero, the turn off dead time can be minimized.

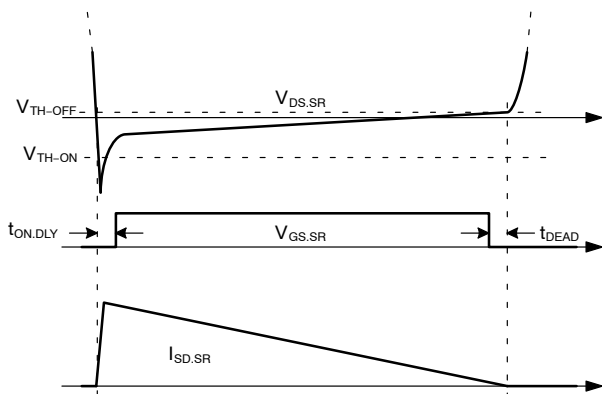

Figure 17. SR MOSFET Operation Waveforms (Ideal Case)

SR Turn-On Algorithm

As the diagram shown in Figure 18, the turn-on of SR GATE is triggered by the three input signals of AND gate. The first input signal is TURN\_ON\_ALLOW signal, which is given after t<sub>OFF-MIN</sub> from the falling edge of V<sub>GS,SR</sub> signal. The second input is the TURN\_ON\_TRG signal, which is enabled after DRAIN pin voltage drops below V<sub>TH-ON</sub>. The third signal is t<sub>ARM</sub> which allows turn-on trigger only when SR drain voltage drops fast with a large slope, preventing SR from triggering by the drain resonance voltage in DCM operation.

SR Turn-Off Algorithm

As diagram shown in Figure 19, the turn-off of SR GATE is triggered by turn off signal, which is enabled when V<sub>DS,SR</sub> > V<sub>TH-OFF</sub>.



# FAN6292CMX

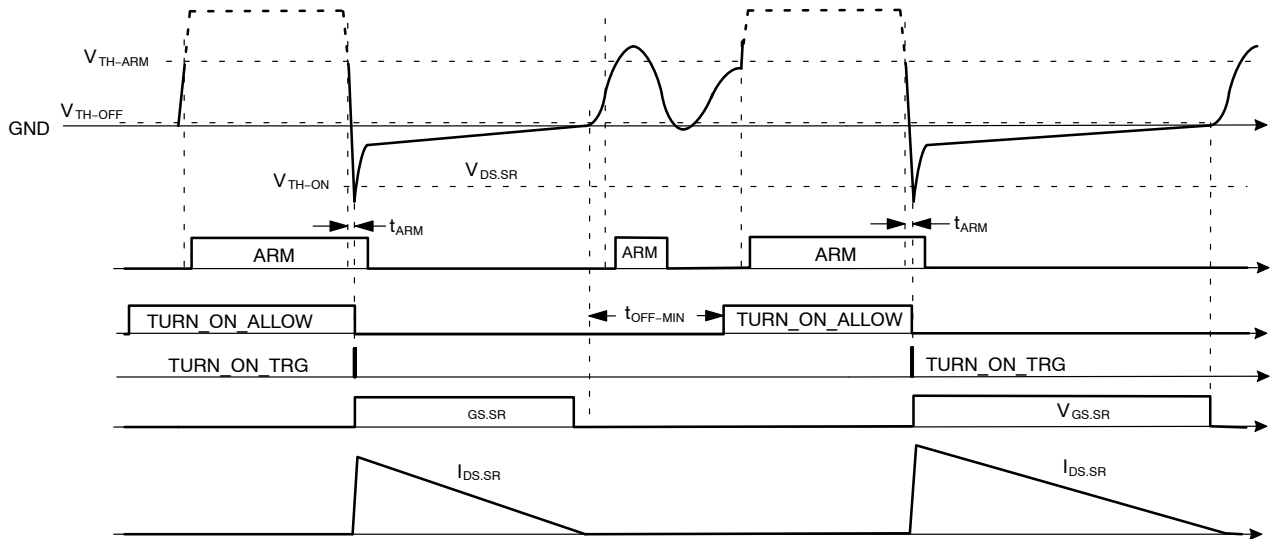

Figure 18. SR Turn-On Algorithm

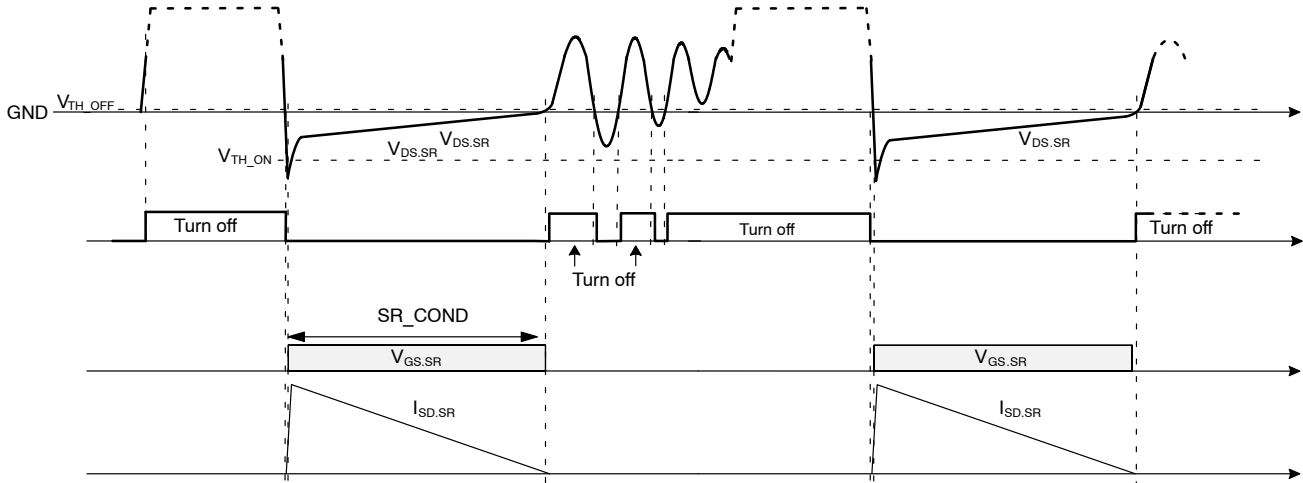

Figure 19. SR Turn-Off Algorithm

## Slope Detection

FAN6292C checks SR drain voltage falling slope to distinguish primary FET off instant from the resonant curve. Continuously sees the time gap between SR drain voltage touches  $V_{TH-ARM}$  and  $V_{TH-ON}$ , this is compared with the internal fixed time of  $t_{ARM}$ , gate is only turn on when the time gap is less than  $t_{ARM}$  described at Figure 20.

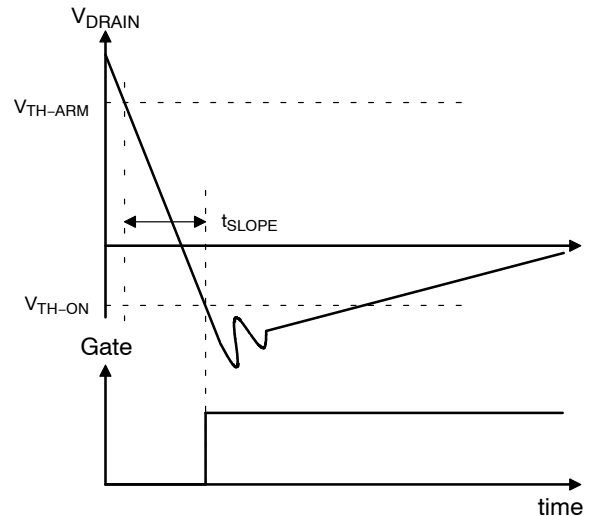

Figure 20. Slope Detection Timing Chart

Slope detection is good for identification SR on instance from the resonance, however, system configuration may give huge impact on the SR drain voltage so slope detection is not always good way for gate ON identification especially at light load. Due to this at light load, slope detection is enabled or disabled depend on period of Gate switching cycles ( $t_s$ ) as below:

- $t_s < (t_{SLO-DIS} - t_{SLO-HYS})$ : continually enable slope detection when  $t_s$  is decreasing
- $t_s \geq t_{SLO-DIS}$ : basically slope detection is disabled and only enabled after gate rising edge until end of  $t_{DRE-EN}$  when  $t_s$  increasing

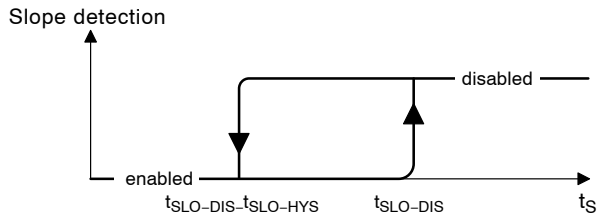

Figure 21. Slope Detect Enable/Disable Depend on  $t_s$

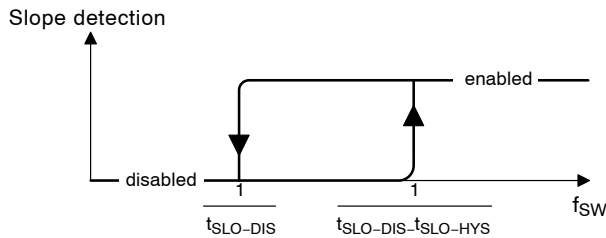

Figure 22. Slope Detect Enable/Disable Depend on  $f_{sw}$

**Gate Turn-On**

FAN6292C turns on SR FET according to the voltage across SR drain and primary switching period of  $t_s$ . Depending on the  $t_s$ , gate turn on criteria is different and it is as below:

- $t_s < t_{SLO-DIS}$ : SR FET ON when both (a) and (b) meet:
  - (a)  $V_{DRAIN}$  falling time from  $V_{TH-ARM}$  to  $V_{TH-ON}$  is less than  $t_{ARM}$
  - (b)  $V_{DRAIN} \leq V_{TH-ON}$
- $t_s < (t_{SLO-DIS} - t_{SLO-HYS})$ : SR FET ON when meet:  $V_{DRAIN} \leq V_{TH-ON}$

**Gate Turn-On Blanking Time**

FAN6292C supports Primary Side Regulation (PSR) operation with Discontinuous Conduction Mode (DCM) and Boundary Conduction Mode (BCM) and the typical operating of Quasi-Resonant valley switching to make the best balance between efficiency and Electro Magnetic Interference (EMI).

Together with slope detection, FAN6292C has a GATE turn on blanking time to avoid SR FET mis-triggered turn on at the first Quasi-Resonant cycle. Blanking time lengths depend on last Gate-to-Gate pulse period. The resonance period is decided by the parasitic capacitance summed at primary side and magnetizing inductance and normally is fixed once system configured but this changes as load changes, typically getting longer as load decreases. This is caused by the parasitic capacitances varies depending on voltage and stored energy at the transformer.

To corresponds this change, FAN6292C adjust minimum OFF time ( $t_{OFF-MIN}$ ) depend on loading condition. Similar as slope detection, when  $t_s$  is shorter than  $t_{SLO-DIS}$ ,  $t_{OFF-MIN}$  becomes  $t_{OFF-MIN-H}$  and when  $t_s$  is longer than  $t_{SLO-DIS}$  with a hysteresis then  $t_{OFF-MIN}$  becomes  $t_{OFF-MIN-L}$ .

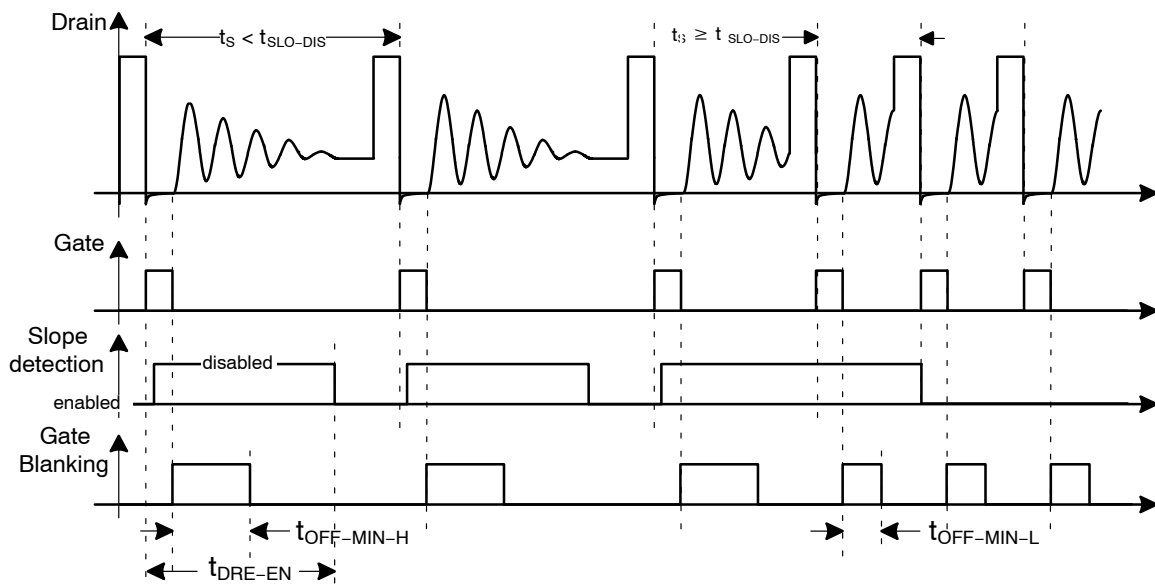

Figure 23. SR Conduction Timing Chart





# MECHANICAL CASE OUTLINE

## PACKAGE DIMENSIONS

ON Semiconductor®



SOIC8  
CASE 751EB  
ISSUE A

DATE 24 AUG 2017

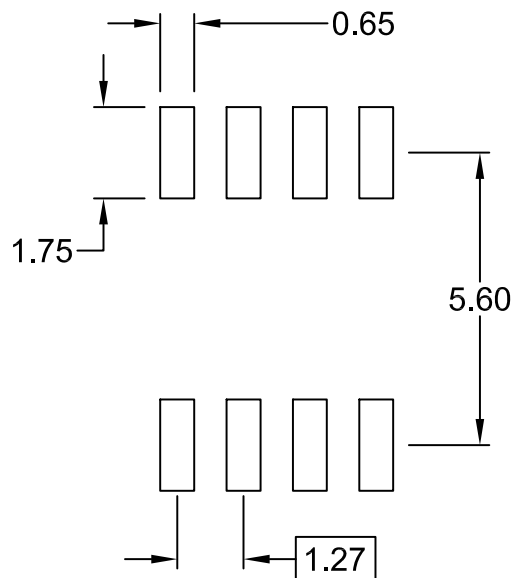

⌀ 0.25 (M) C B A

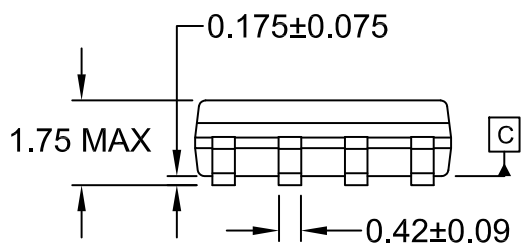

0.10

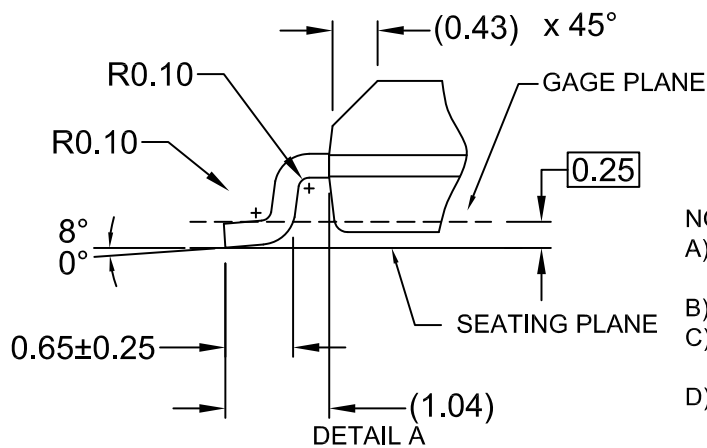
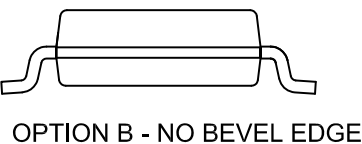
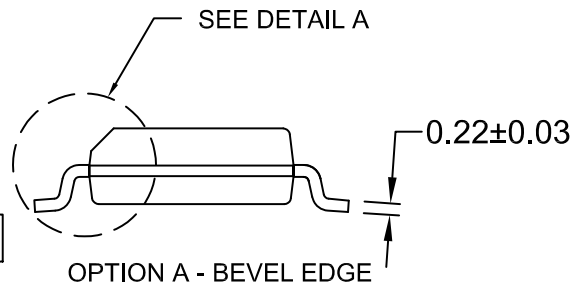

SCALE: 2:1

NOTES:

- A) THIS PACKAGE CONFORMS TO JEDEC MS-012, VARIATION AA.
- B) ALL DIMENSIONS ARE IN MILLIMETERS.
- C) DIMENSIONS DO NOT INCLUDE MOLD FLASH OR BURRS.
- D) LANDPATTERN STANDARD: SOIC127P600X175-8M

|                  |             |  |
|------------------|-------------|--|
| DOCUMENT NUMBER: | 98AON13735G | Electronic versions are uncontrolled except when accessed directly from the Document Repository. Printed versions are uncontrolled except when stamped "CONTROLLED COPY" in red. |
| DESCRIPTION:     | SOIC8       | PAGE 1 OF 1  |

ON Semiconductor and ON are trademarks of Semiconductor Components Industries, LLC dba ON Semiconductor or its subsidiaries in the United States and/or other countries. ON Semiconductor reserves the right to make changes without further notice to any products herein. ON Semiconductor makes no warranty, representation or guarantee regarding the suitability of its products for any particular purpose, nor does ON Semiconductor assume any liability arising out of the application or use of any product or circuit, and specifically disclaims any and all liability, including without limitation special, consequential or incidental damages. ON Semiconductor does not convey any license under its patent rights nor the rights of others.

ON Semiconductor and  are trademarks of Semiconductor Components Industries, LLC dba ON Semiconductor or its subsidiaries in the United States and/or other countries. ON Semiconductor owns the rights to a number of patents, trademarks, copyrights, trade secrets, and other intellectual property. A listing of ON Semiconductor's product/patent coverage may be accessed at [www.onsemi.com/site/pdf/Patent-Marking.pdf](http://www.onsemi.com/site/pdf/Patent-Marking.pdf). ON Semiconductor reserves the right to make changes without further notice to any products herein. ON Semiconductor makes no warranty, representation or guarantee regarding the suitability of its products for any particular purpose, nor does ON Semiconductor assume any liability arising out of the application or use of any product or circuit, and specifically disclaims any and all liability, including without limitation special, consequential or incidental damages. Buyer is responsible for its products and applications using ON Semiconductor products, including compliance with all laws, regulations and safety requirements or standards, regardless of any support or applications information provided by ON Semiconductor. "Typical" parameters which may be provided in ON Semiconductor data sheets and/or specifications can and do vary in different applications and actual performance may vary over time. All operating parameters, including "Typicals" must be validated for each customer application by customer's technical experts. ON Semiconductor does not convey any license under its patent rights nor the rights of others. ON Semiconductor products are not designed, intended, or authorized for use as a critical component in life support systems or any FDA Class 3 medical devices or medical devices with a same or similar classification in a foreign jurisdiction or any devices intended for implantation in the human body. Should Buyer purchase or use ON Semiconductor products for any such unintended or unauthorized application, Buyer shall indemnify and hold ON Semiconductor and its officers, employees, subsidiaries, affiliates, and distributors harmless against all claims, costs, damages, and expenses, and reasonable attorney fees arising out of, directly or indirectly, any claim of personal injury or death associated with such unintended or unauthorized use, even if such claim alleges that ON Semiconductor was negligent regarding the design or manufacture of the part. ON Semiconductor is an Equal Opportunity/Affirmative Action Employer. This literature is subject to all applicable copyright laws and is not for resale in any manner.

## PUBLICATION ORDERING INFORMATION

### LITERATURE FULFILLMENT:

Email Requests to: [orderlit@onsemi.com](mailto:orderlit@onsemi.com)

ON Semiconductor Website: [www.onsemi.com](http://www.onsemi.com)

### TECHNICAL SUPPORT

North American Technical Support:  
Voice Mail: 1 800-282-9855 Toll Free USA/Canada  
Phone: 011 421 33 790 2910

Europe, Middle East and Africa Technical Support:

Phone: 00421 33 790 2910

For additional information, please contact your local Sales Representative