

# Smart high-side NMOS-power switch

**ITS4300S-SJ-D**



## Features

- CMOS compatible input
- Switching all types of resistive, inductive and capacitive loads
- Fast demagnetization of inductive loads
- Very low standby current
- Optimized Electromagnetic Compatibility (EMC)
- Open drain diagnostic output for overtemperature and short circuit
- Open load detection in OFF-state with external resistor
- Overload protection
- Current limitation
- Short circuit protection
- Thermal shutdown with restart
- Overvoltage protection (including load dump)
- Reverse battery protection with external resistor
- Loss of GND and loss of Vbb protection
- Electrostatic Discharge Protection (ESD)
- Green Product (RoHS compliant)

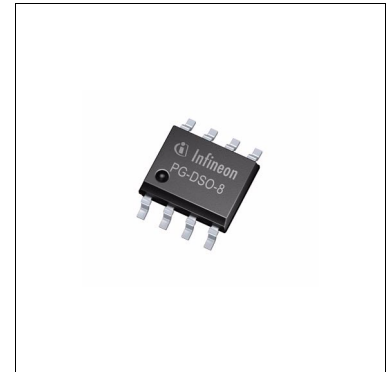

## Applications

- All types of resistive, inductive and capacitive loads
- Power switch for 12V and 24V DC applications with CMOS compatible control interface
- Driver for electromagnetic relays
- Power management for high-side-switching with low current consumption in OFF-mode

## Product Validation

Qualified for industrial applications according to the relevant tests of JEDEC.

## Description

The ITS4300S-SJ-D is a protected single channel Smart High-Side NMOS-Power Switch in a PG-DSO-8 package with charge pump, CMOS compatible input and diagnostic feedback.

**Table 1** Product summary

Parameter	Symbol	Values
Overvoltage protection	$V_{SAZmin}$	41 V
Operating voltage range	$V_S$	$5V < V_S < 34V$
On-state resistance	$R_{DSON}$	typ. 300 m $\Omega$
Nominal load current	$I_{L(nom)}$	0.4 A
Operating temperature range	$T_j$	-40°C to 125°C
Stand-by current	$I_{SSTB}$	26 $\mu$ A

Type	Package	Marking
ITS4300S-SJ-D	PG-DSO-8	I300SD

## Table of Contents

<b>1</b>	<b>Block diagram and terms</b> .....	<b>4</b>
<b>2</b>	<b>Pin configuration</b> .....	<b>5</b>
2.1	Pin assignment .....	5
2.2	Pin definitions and functions .....	5
<b>3</b>	<b>General product characteristics</b> .....	<b>6</b>
3.1	Absolute maximum ratings .....	6
3.2	Functional range .....	7
3.3	Thermal resistance .....	7
<b>4</b>	<b>Electrical Characteristics</b> .....	<b>8</b>
<b>5</b>	<b>Typical performance graphs</b> .....	<b>11</b>
<b>6</b>	<b>Application information</b> .....	<b>16</b>
6.1	Application diagram .....	16
6.2	Diagnosis description .....	17
6.3	Special feature description .....	18
6.4	Typical application waveforms .....	19
6.5	Protection behavior .....	20
<b>7</b>	<b>Package information</b> .....	<b>21</b>
<b>8</b>	<b>Revision history</b> .....	<b>22</b>

Block diagram and terms

1 Block diagram and terms

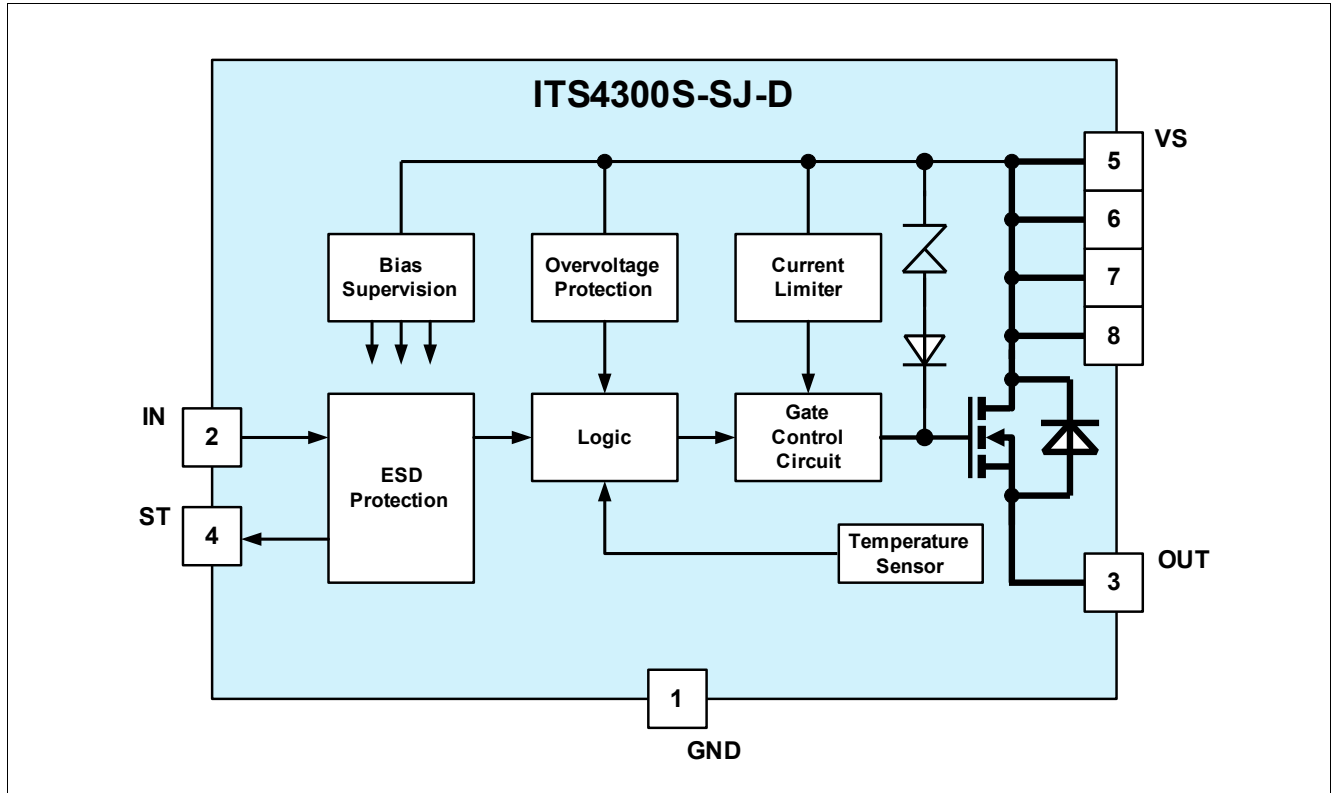

Figure 1 Block diagram

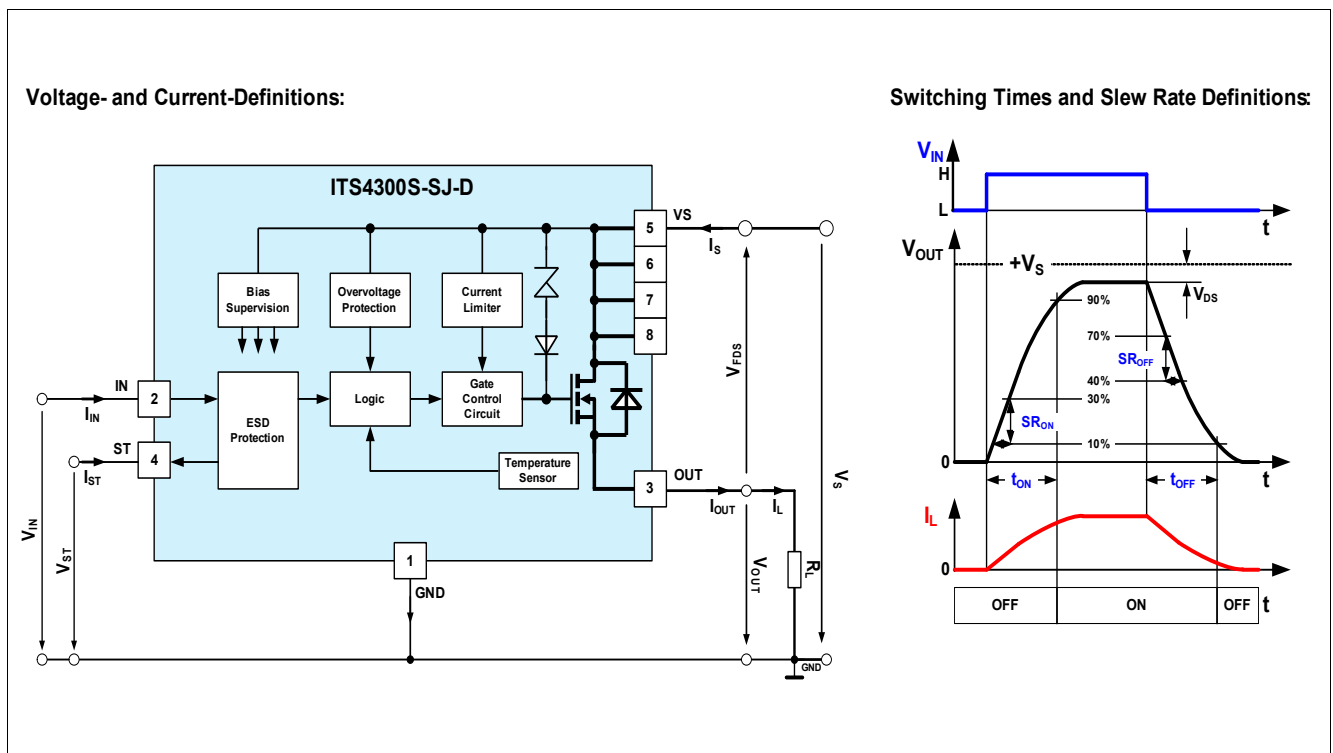

Figure 2 Terms - parameter definition

Pin configuration

## 2 Pin configuration

### 2.1 Pin assignment

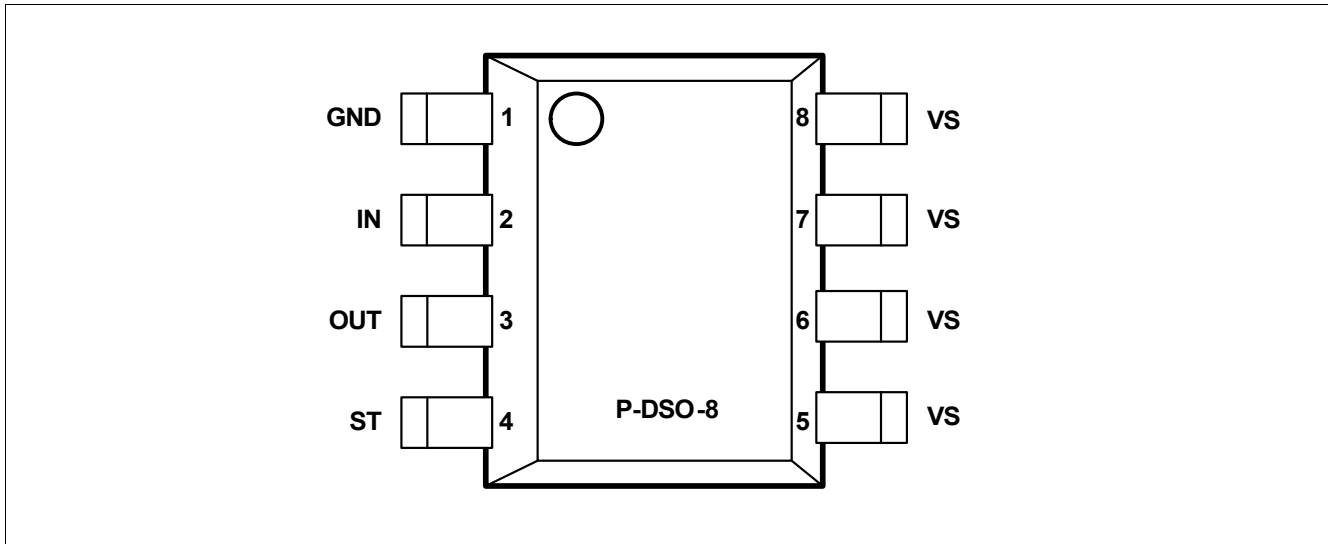

Figure 3 Pin configuration top view, PG-DSO-8

### 2.2 Pin definitions and functions

Pin	Symbol	Function
1	GND	Logic ground
2	IN	Input, controls the power switch; the powerswitch is ON when high
3	OUT	Output to the load
4	ST	Status flag; diagnosis feedback; NMOS open drain
5, 6, 7, 8	VS	Supply voltage (design the wiring for the maximum short circuit current and also for low thermal resistance)

General product characteristics

### 3 General product characteristics

#### 3.1 Absolute maximum ratings

**Table 2 Absolute maximum ratings<sup>1)</sup> at  $T_j = 25^\circ\text{C}$  unless otherwise specified. Currents flowing into the device unless otherwise specified in chapter “Block Diagram and Terms”**

Parameter	Symbol	Values			Unit	Note or Test Condition	Number
		Min.	Typ.	Max.			
<b>Supply voltage VS</b>							
Voltage	$V_S$	-	-	40	V	-	4.1.1
Voltage for short circuit protection	$V_{SSC}$	-	-	28	V	-	4.1.2
<b>Output stage OUT</b>							
Output current; (short circuit current see electrical characteristics)	$I_{OUT}$	-	-	self limited	A	-	4.1.3
<b>Input IN</b>							
Voltage	$V_{IN}$	-10	-	16	V	-	4.1.4
Current	$I_{IN}$	-5	-	5	mA	-	4.1.5
<b>Status ST</b>							
Current	$I_{ST}$	-5	-	5	mA	-	4.1.6
<b>Temperatures</b>							
Junction temperature	$T_j$	-40	-	125	$^\circ\text{C}$	-	4.1.7
Storage temperature	$T_{stg}$	-55	-	125	$^\circ\text{C}$	-	4.1.8
<b>Power dissipation</b>							
$T_a = 25^\circ\text{C}^{2)}$	$P_{tot}$	-	-	1.4	W	-	4.1.9
<b>Inductive load switch-off energy dissipation</b>							
$T_j = 125^\circ\text{C}; V_S = 13.5\text{V}; I_L = 0.3\text{A}^{3)}$	$E_{AS}$	-	-	800	mJ	single pulse	4.1.10
<b>ESD susceptibility</b>							
ESD susceptibility (input pin IN)	$V_{ESD}$	-1	-	1	kV	HBM <sup>4)</sup>	4.1.11
ESD susceptibility (output pin OUT)	$V_{ESD}$	-6	-	6	kV	HBM <sup>4)</sup>	4.1.13
ESD susceptibility (all other pins)	$V_{ESD}$	-3	-	3	kV	HBM <sup>4)</sup>	4.1.12

1) Not subject to production test, specified by design

2) Device on 50mm\*50mm\*1.5mm epoxy PCB FR4 with 6 cm<sup>2</sup> (one layer, 70mm thick) copper area for Vbb connection. PCB is vertical without blown air

3) Not subject to production test, specified by design

4) ESD susceptibility HBM according to ANSI/ESDA/JEDEC J001 (1.5k $\Omega$ , 100pF).

*Note: Exposure to absolute maximum rating conditions for extended periods may affect device reliability. Integrated protection functions are designed to prevent IC destruction under fault conditions described in the data sheet. Fault conditions are considered as “outside” the normal operating range. Protection functions are neither designed for continuous nor repetitive operation.*

General product characteristics

### 3.2 Functional range

**Table 3 Functional range**

Parameter	Symbol	Values			Unit	Note or Test Condition	Number
		Min.	Typ.	Max.			
Nominal operating voltage	$V_S$	5	–	34	V	$V_S$ increasing	4.2.1

Note: Within the functional range the IC operates as described in the circuit description. The electrical characteristics are specified within the conditions given in the related electrical characteristics table.

### 3.3 Thermal resistance

Note: This thermal data was generated in accordance with JEDEC JESD51 standards. For more information, go to [www.jedec.org](http://www.jedec.org).

**Table 4 Thermal resistance<sup>1)</sup>**

Parameter	Symbol	Values			Unit	Note or Test Condition	Number
		Min.	Typ.	Max.			
Thermal resistance - junction to pin5	$R_{thj-pin5}$	–	34.5	–	K/W	–	4.3.1
Thermal resistance - junction to ambient - 1s0p, minimal footprint	$R_{thJA_1s0p}$	–	145	–	K/W	<sup>2)</sup>	4.3.2
Thermal resistance - junction to ambient - 1s0p, 300mm <sup>2</sup>	$R_{thJA_1s0p_300mm}$	–	89	–	K/W	<sup>3)</sup>	4.3.3
Thermal resistance - junction to ambient - 1s0p, 600mm <sup>2</sup>	$R_{thJA_1s0p_600mm}$	–	78	–	K/W	<sup>4)</sup>	4.3.4
Thermal resistance - junction to ambient - 2s2p	$R_{thJA_2s2p}$	–	85	–	K/W	<sup>5)</sup>	4.3.5
Thermal resistance - junction to ambient with thermal vias - 2s2p	$R_{thJA_2s2p}$	–	60.4	–	K/W	<sup>6)</sup>	4.3.6

1) Not subject to production test, specified by design

2) Specified  $R_{thJA}$  value is according to Jedec JESD51-3 at natural convection on FR4 1s0p board, footprint; the product (Chip+Package) was simulated on a 76.2 x 114.3 x 1.5 mm board with 1x 70µm Cu.

3) Specified  $R_{thJA}$  value is according to Jedec JESD51-3 at natural convection on FR4 1s0p board, Cu, 300mm<sup>2</sup>; the Product (Chip+Package) was simulated on a 76.2 x 114.3 x 1.5 mm board with 1x 70µm Cu.

4) Specified  $R_{thJA}$  value is according to Jedec JESD51-3 at natural convection on FR4 1s0p board, 600mm<sup>2</sup>; the product (Chip+Package) was simulated on a 76.2 x 114.3 x 1.5 mm board with 1x 70µm Cu.

5) Specified  $R_{thJA}$  value is according to Jedec JESD51-2,-5,-7 at natural convection on FR4 2s2p board; the product (Chip+Package) was simulated on a 76.2 x 114.3 x 1.5 mm board with 2 inner copper layers (2 x 70µm Cu, 2 x 35µm Cu).

6) Specified  $R_{thJA}$  value is according to Jedec JESD51-2,-5,-7 at natural convection on FR4 2s2p board with two thermal vias; the Product (Chip+Package) was simulated on a 76.2 x 114.3 x 1.5 mm board with 2 inner copper layers (2 x 70µm Cu, 2 x 35µm Cu). The diameter of the two vias are equal 0.3mm and have a plating of 25µm with a copper heatsink area of 3mm x 2mm). JEDEC51-7: The two plated-through hole vias should have a solder land of no less than 1.25 mm diameter with a drill hole of no less than 0.85 mm diameter.

Electrical Characteristics

## 4 Electrical Characteristics

**Table 5**  $V_S=13.5V$ ;  $T_j = -40^\circ\text{C}$  to  $+125^\circ\text{C}$ ; all voltages with respect to ground. Currents flowing into the device unless otherwise specified in chapter “Block Diagram and Terms”. Typical values at  $V_S = 13.5V$ ,  $T_j = 25^\circ\text{C}$

Parameter	Symbol	Values			Unit	Note or Test Condition	Number
		Min.	Typ.	Max.			
<b>Powerstage</b>							
NMOS ON resistance	$R_{\text{DSON}}$	–	300	400	m $\Omega$	$I_{\text{OUT}}=0.3\text{A}$ ; $T_j = 25^\circ\text{C}$ ; $9\text{V} < V_S < 34\text{V}$ ; $V_{\text{IN}}=5\text{V}$	5.0.1
NMOS ON resistance	$R_{\text{DSON}}$	–	480	600	m $\Omega$	$I_{\text{OUT}}=0.3\text{A}$ ; $T_j = 125^\circ\text{C}$ ; $9\text{V} < V_S < 34\text{V}$ ; $V_{\text{IN}}=5\text{V}$	5.0.2
Nominal load current; device on PCB <sup>1)</sup>	$I_{\text{LNOM}}$	0.4	–	–	A	$T_{\text{pin5}} = 85^\circ\text{C}$	5.0.3
<b>Timings of power stages<sup>2)</sup></b>							
Turn ON time (to 90% of $V_{\text{out}}$ ); L to H transition of $V_{\text{IN}}$	$t_{\text{ON}}$	–	–	140	$\mu\text{s}$	$V_S=13.5\text{V}$ ; $R_L = 47\Omega$	5.0.4
Turn OFF time (to 10% of $V_{\text{out}}$ ); H to L transition of $V_{\text{IN}}$	$t_{\text{OFF}}$	–	–	170	$\mu\text{s}$	$V_S=13.5\text{V}$ ; $R_L = 47\Omega$	5.0.5
ON-slew rate; $\Delta V_{\text{OUT}}/\Delta t$ ; (10 to 30% of $V_{\text{out}}$ ); L to H transition of $V_{\text{IN}}$	$SR_{\text{ON}}$	–	–	2.0	V/ $\mu\text{s}$	$V_S=13.5\text{V}$ ; $R_L = 47\Omega$	5.0.6
OFF-slew rate; $\Delta V_{\text{OUT}}/\Delta t$ ; (70 to 40% of $V_{\text{out}}$ ); H to L transition of $V_{\text{IN}}$	$SR_{\text{OFF}}$	–	–	2.0	V/ $\mu\text{s}$	$V_S=13.5\text{V}$ ; $R_L = 47\Omega$	5.0.7
<b>Under voltage lockout (charge pump start-stop-restart)</b>							
Supply undervoltage; charge pump stop voltage	$V_{\text{SUV}}$	–	–	5.5	V	$V_S$ decreasing	5.0.8
Supply startup voltage; Charge pump restart voltage	$V_{\text{SSU}}$	–	–	5.5	V	$V_S$ increasing	5.0.9
<b>Current consumption</b>							
Operating current	$I_{\text{GND}}$	–	–	1.3	mA	$V_{\text{IN}}=5\text{V}$	5.0.10
Standby current	$I_{\text{SSTB}}$	–	–	26	$\mu\text{A}$	$V_{\text{IN}}=0\text{V}$ ; $V_{\text{OUT}}=0\text{V}$ $-40^\circ\text{C} < T_j < 85^\circ\text{C}$	5.0.11
Standby current	$I_{\text{SSTB}}$	–	–	26	$\mu\text{A}$	$V_{\text{IN}}=0\text{V}$ ; $T_j = 125^\circ\text{C}$	5.0.12
Output leakage current	$I_{\text{OUTLK}}$	–	–	12	$\mu\text{A}$	$V_{\text{IN}}=0\text{V}$ ; $V_{\text{OUT}}=0\text{V}$	5.0.13
<b>Protection functions<sup>3)</sup></b>							
Initial peak short circuit current limit	$I_{\text{LSCP}}$	–	–	2	A	$T_j = -40^\circ\text{C}$ ; $V_S = 20\text{V}$ ; $V_{\text{IN}} = 5.0\text{V}$	5.0.14

Electrical Characteristics

**Table 5**  $V_S=13.5V$ ;  $T_j = -40^{\circ}C$  to  $+125^{\circ}C$ ; all voltages with respect to ground. Currents flowing into the device unless otherwise specified in chapter “Block Diagram and Terms”. Typical values at  $V_S = 13.5V$ ,  $T_j = 25^{\circ}C$

Parameter	Symbol	Values			Unit	Note or Test Condition	Number
		Min.	Typ.	Max.			
Initial peak short circuit current limit	$I_{LSCP}$	–	1.2	–	A	$T_j = 25^{\circ}C$ ; $V_S = 20V$ ; $V_{IN} = 5.0V$	5.0.15
Initial peak short circuit current limit	$I_{LSCP}$	0.4	–	–	A	$T_j = 125^{\circ}C$ ; $V_S = 20V$ ; $V_{IN} = 5.0V$	5.0.16
Repetitive short circuit current limit $T_j = T_{jTrip}$ ; see timing diagrams	$I_{LSCR}$	–	1	–	A	$V_{IN} = 5.0V$	5.0.17
Output clamp at $V_{OUT} = V_S - V_{DSCL}$ (inductive load switch off)	$V_{DSCL}$	41	47	–	V	$I_S = 4mA$	5.0.18
Oversvoltage protection $V_{OUT} = V_S - V_{ONCL}$	$V_{SAZ}$	41	–	–	V	$I_S = 4mA$	5.0.19
Thermal overload trip temperature	$T_{jTrip}$	150	–	–	$^{\circ}C$		5.0.20
Thermal hysteresis	$T_{HYS}$	–	10	–	K		5.0.21
<b>Reverse Battery<sup>4)</sup></b>							
Continuous reverse battery voltage	$V_{SREV}$	-32	–	–	V		5.0.22
Forward voltage of the drain-source reverse diode	$V_{FDS}$	–	600	–	mV	$I_{FDS} = 200mA$ ; $V_{IN} = 0V$ ; $T_j = 125^{\circ}C$	5.0.23
<b>Input interface; pin IN</b>							
Input turn-ON voltage (logic input high-level)	$V_{INON}$	2.2	–	–	V		5.0.24
Input turn-OFF voltage (logic input low-level)	$V_{INOFF}$	–	–	0.8	V		5.0.25
Input threshold hysteresis	$V_{INHYS}$	–	0.3	–	V		5.0.26
Off state input current	$I_{INOFF}$	1	–	30	$\mu A$	$V_{IN} = 0.7V$	5.0.27
On state input current	$I_{INON}$	1	–	30	$\mu A$	$V_{IN} = 5.0V$	5.0.28
Input resistance	$R_{IN}$	1.5	3.5	5.0	k $\Omega$		5.0.29
<b>Status output (NMOS open drain); pin ST</b>							
Status output zener voltage	$V_{STZ}$	5.4	6.1	6.8	V	$I_{ST} = 1.6mA$	5.0.30
Status output low voltage	$V_{STLO}$	–	–	0.4	V	$I_{ST} = 1.6mA$ $T_j < 25^{\circ}C$	5.0.31
Status output low voltage	$V_{STLO}$	–	–	0.6	V	$I_{ST} = 1.6mA$ $T_j < 125^{\circ}C$	5.0.32
Status leakage current	$I_{STLK}$	–	–	2	$\mu A$	$V_{ST} = 5V$ $T_j < 105^{\circ}C$	5.0.33
Status invalid time after positive input slope <sup>5)</sup>	$t_{dP}$	–	300	600	$\mu s$	$V_S = 20V$	5.0.34

Electrical Characteristics

**Table 5**  $V_S=13.5V$ ;  $T_j = -40^{\circ}C$  to  $+125^{\circ}C$ ; all voltages with respect to ground. Currents flowing into the device unless otherwise specified in chapter “Block Diagram and Terms”. Typical values at  $V_S = 13.5V$ ,  $T_j = 25^{\circ}C$

Parameter	Symbol	Values			Unit	Note or Test Condition	Number
		Min.	Typ.	Max.			
<b>Diagnostic characteristics</b>							
Short circuit detection voltage	$V_{OUTSC}$	–	2.8	–	V		5.0.35
Open load detection voltage <sup>6)</sup>	$V_{OUTOL}$	–	3	–	V		5.0.36
Open load detection current <sup>7)</sup> (included in standby current)	$I_{OUTOL}$	–	5	–	$\mu A$	$V_{OUT} = 4V$	5.0.37

- 1) Device on 50mm x 50mm x 1,5mm epoxy FR4 PCB with 6cm<sup>2</sup> (one layer copper 70um thick) copper area for supply voltage connection. PCB in vertical position without blown air.
- 2) Timing values only with high slewrate input signal; otherwise slower.
- 3) Integrated protection functions are designed to prevent IC destruction under fault conditions described in the data sheet. Fault conditions are considered as “outside” normal operating range. Protection functions are not designed for continuous repetitive operation.
- 4) Requires a 150W resistor in GND connection. The reverse load current trough the intrinsic drain-source diode of the power-MOS has to be limited by the connected load. Power dissipation is higher compared to normal operation due to the voltage drop across the drain-source diode. The temperature protection is not functional during reverse current operation! Input current has to be limited (see max ratings).
- 5) No delay time after overtemparature switch off and short circuit in on-state.
- 6) External pull up resistor required for open load detection in off state.
- 7) External pull up resistor required for open load detection in off state.

Typical performance graphs

## 5 Typical performance graphs

### Typical performance characteristics

Transient thermal impedance  $Z_{thJA}$  versus pulse time  $t_p$  @ 6cm<sup>2</sup> heatsink area

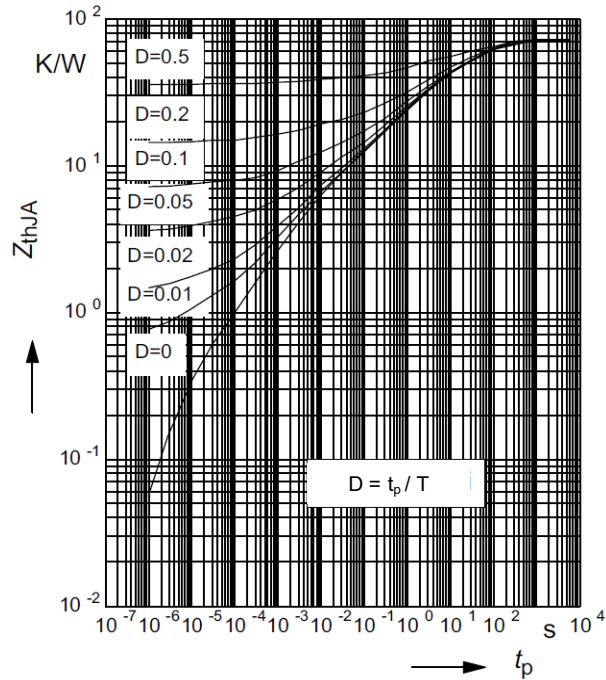

Transient thermal impedance  $Z_{thJA}$  versus pulse time  $t_p$  @ minimum footprint

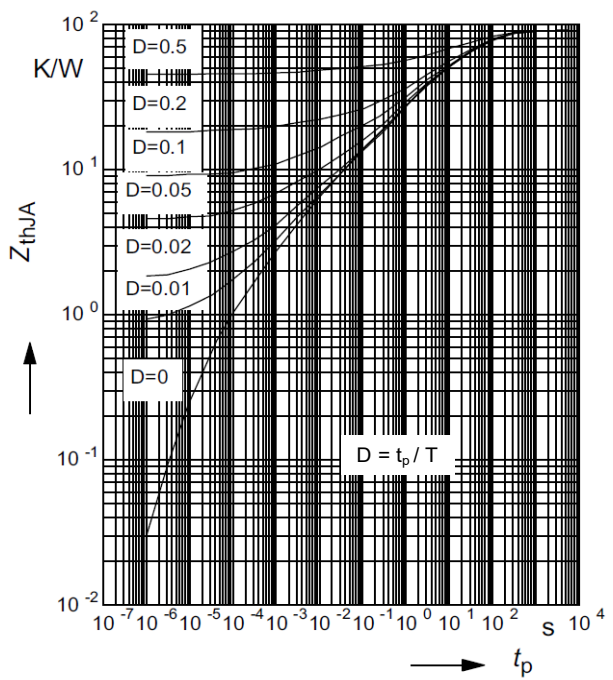

On-resistance  $R_{DSON}$  versus junction temperature  $T_j$

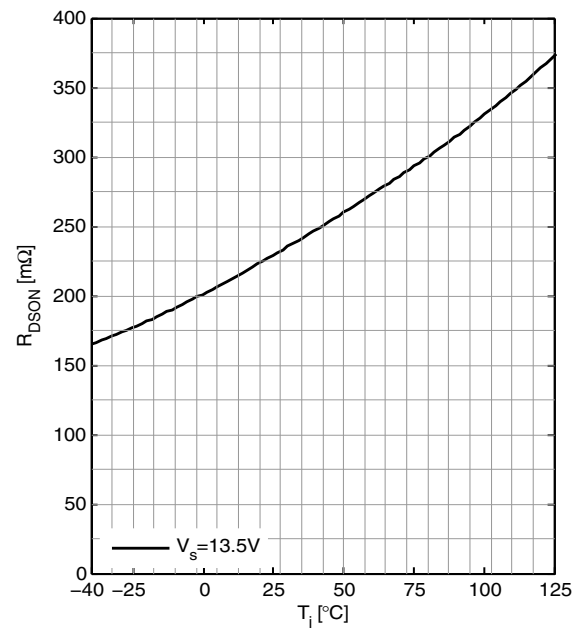

On-resistance  $R_{DSON}$  versus supply voltage  $V_s$

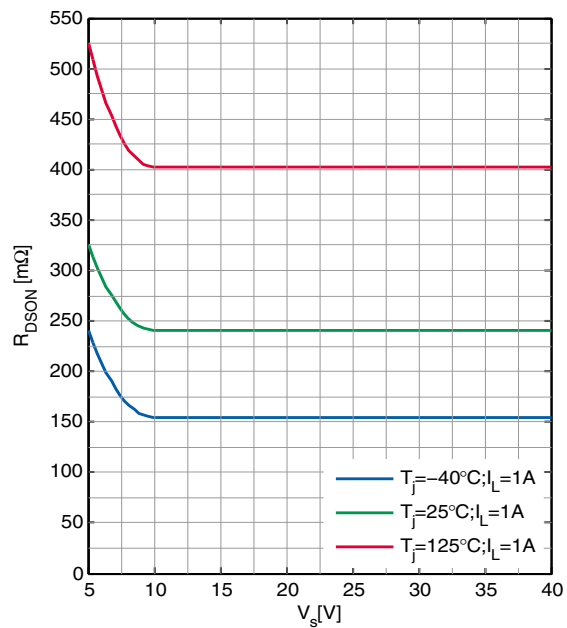

Typical performance graphs

Typical performance characteristics

Switch ON time  $t_{ON}$  versus junction temperature  $T_j$

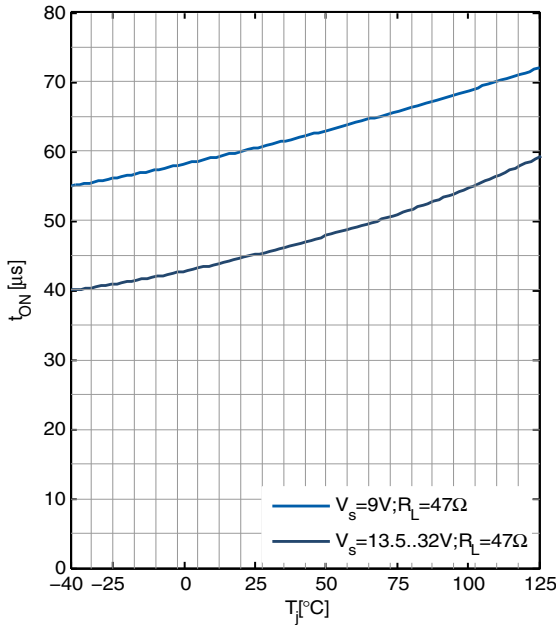

Switch OFF time  $t_{OFF}$  versus junction temperature  $T_j$

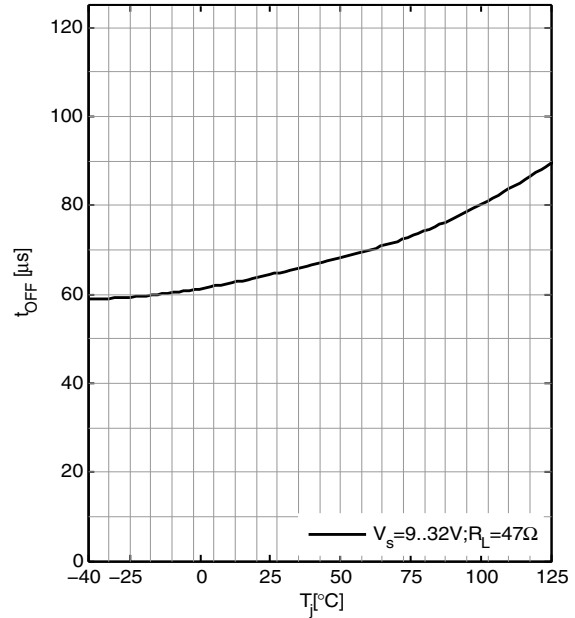

ON slewrate  $SR_{ON}$  versus junction temperature  $T_j$

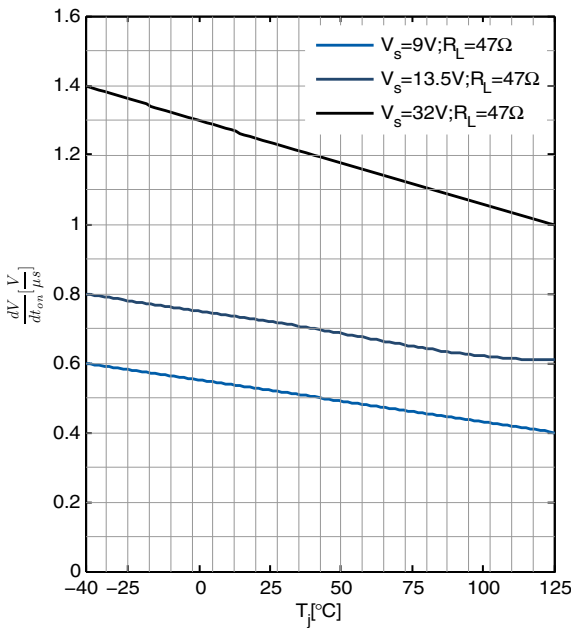

OFF slewrate  $SR_{OFF}$  versus junction temperature  $T_j$

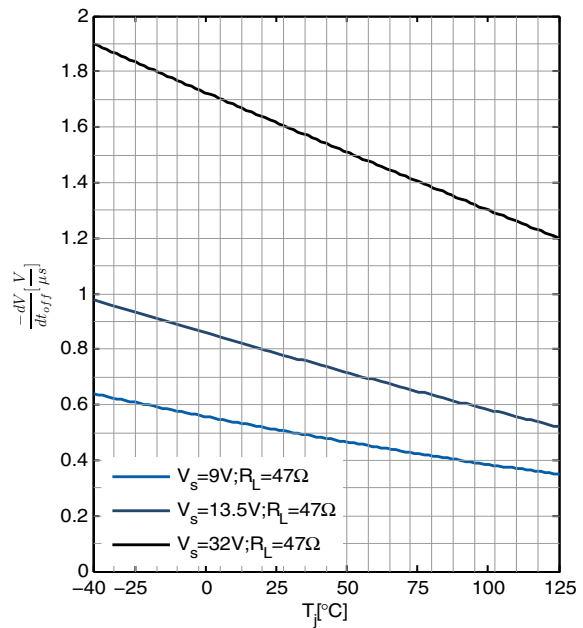

Typical performance graphs

Typical performance characteristics

Standby current  $I_{SSTB}$  versus junction temperature  $T_j$

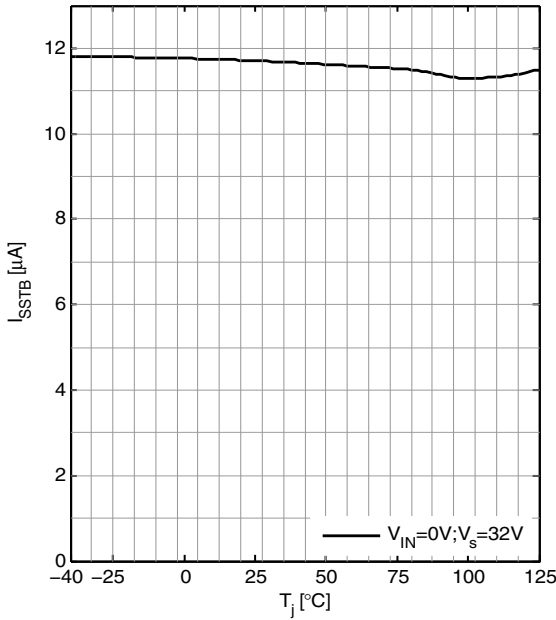

Output leakage current  $I_{OUTLK}$  versus junction temperature  $T_j$

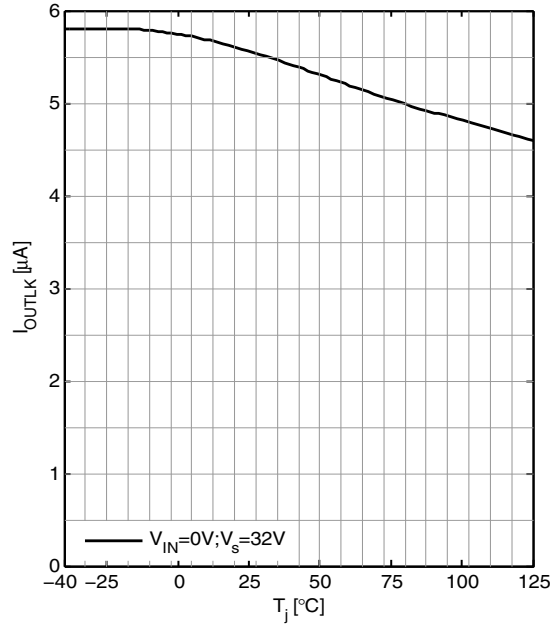

Initial peak short circuit current limit  $I_{LSCP}$  versus junction temperature  $T_j$

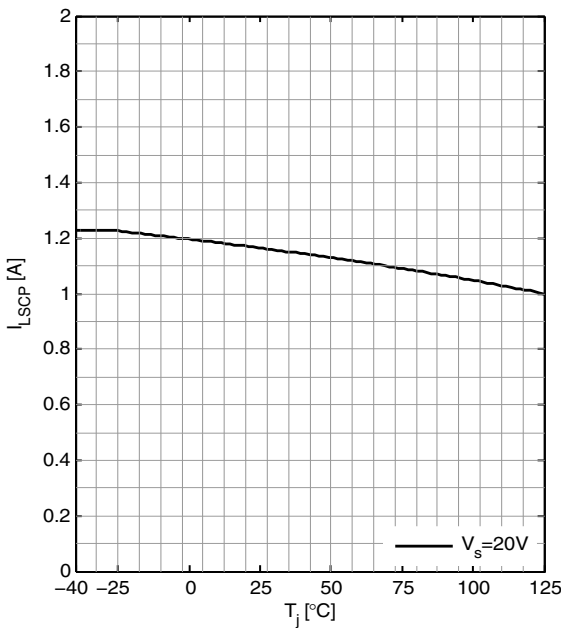

Initial short circuit shutdown time  $t_{SCOFF}$  versus junction temperature  $T_j$

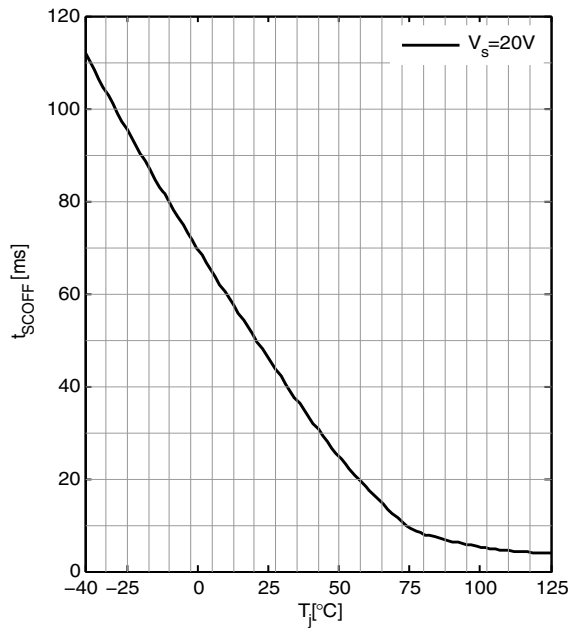

Typical performance graphs

Typical performance characteristics

Input current consumption  $I_{IN}$  versus junction temperature  $T_j$

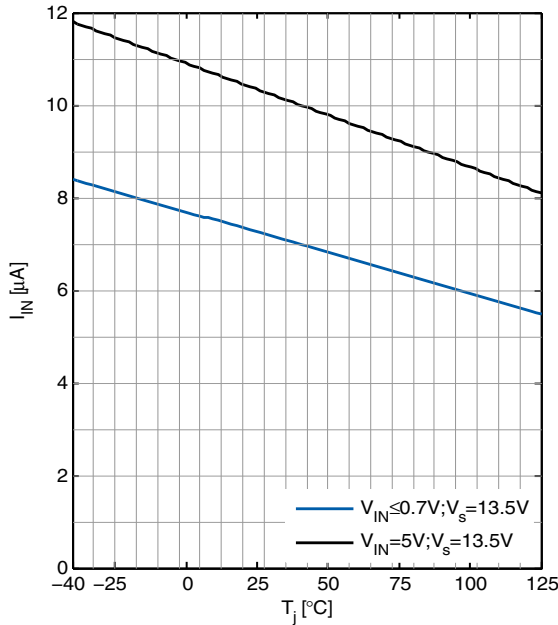

Input current consumption  $I_{IN}$  versus input voltage  $V_{IN}$

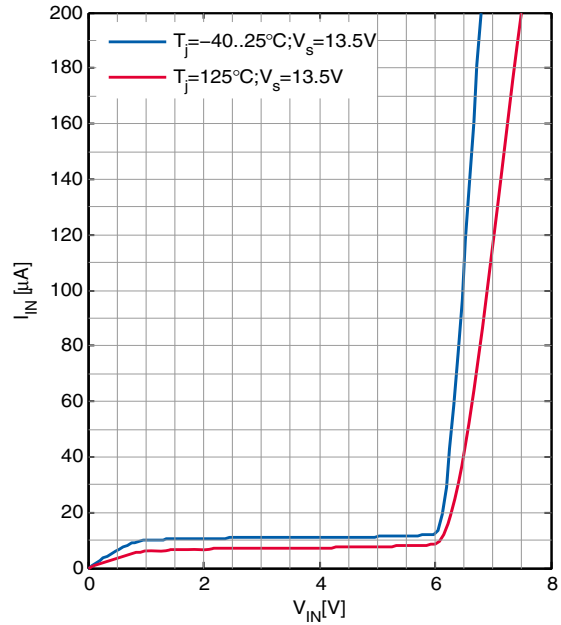

Input threshold voltage  $V_{IN,H,L}$  versus junction temperature  $T_j$

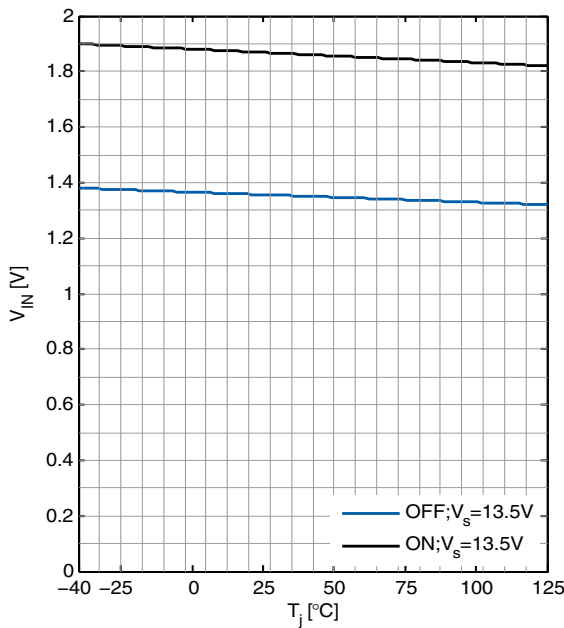

Input threshold voltage  $V_{IN,H,L}$  versus supply voltage  $V_S$

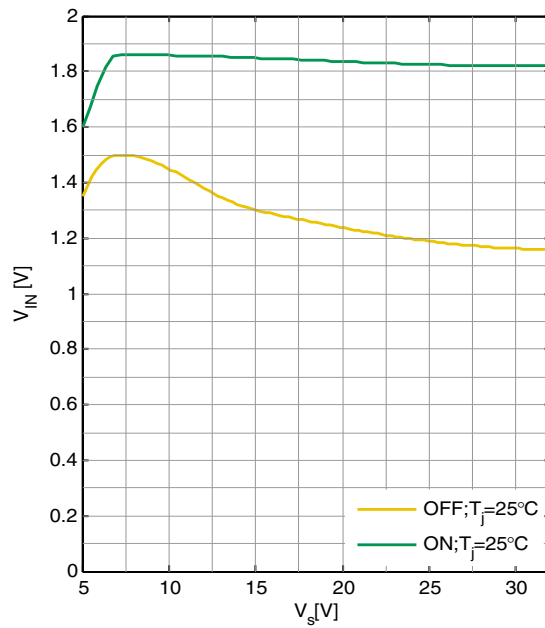

Typical performance graphs

Typical performance characteristics

Max. allowable load inductance  $L$  versus load current  $I_L$

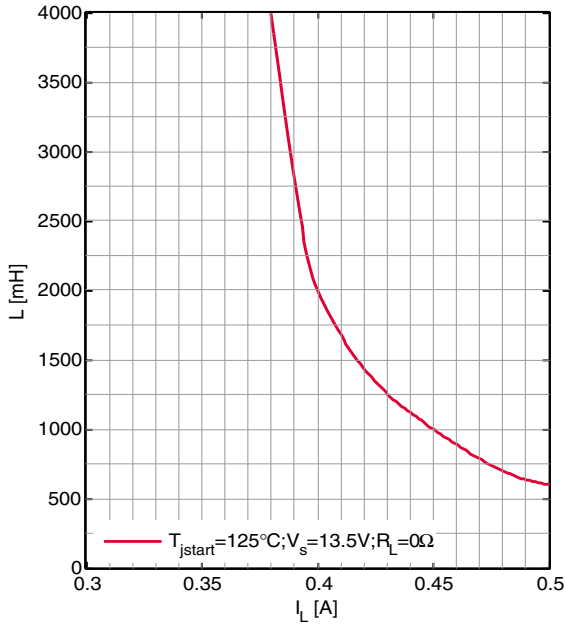

Max. allowable inductive single pulse switch-off Energy  $E_{AS}$  versus load current  $I_L$

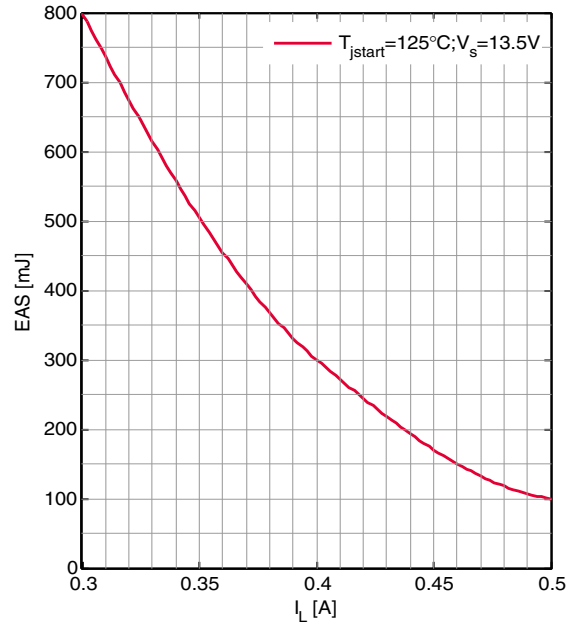

Status delay time  $t_{dp}$  versus supply voltage  $V_s$

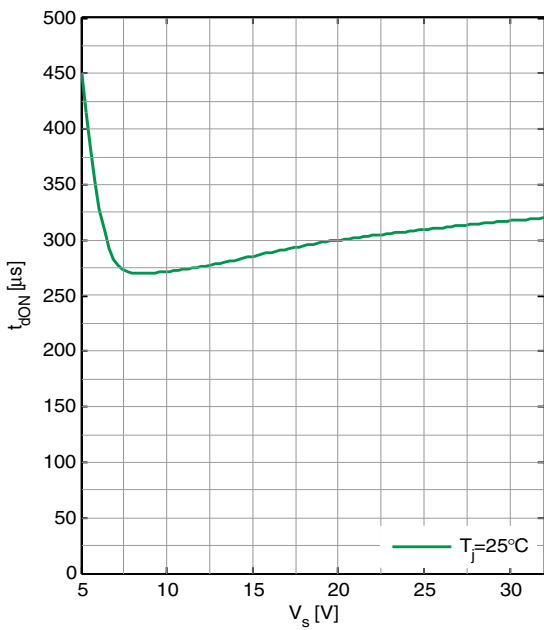

## 6 Application information

### 6.1 Application diagram

The following information is given as a hint for the implementation of the device only and shall not be regarded as a description or warranty for a certain functionality, condition or quality of the device.

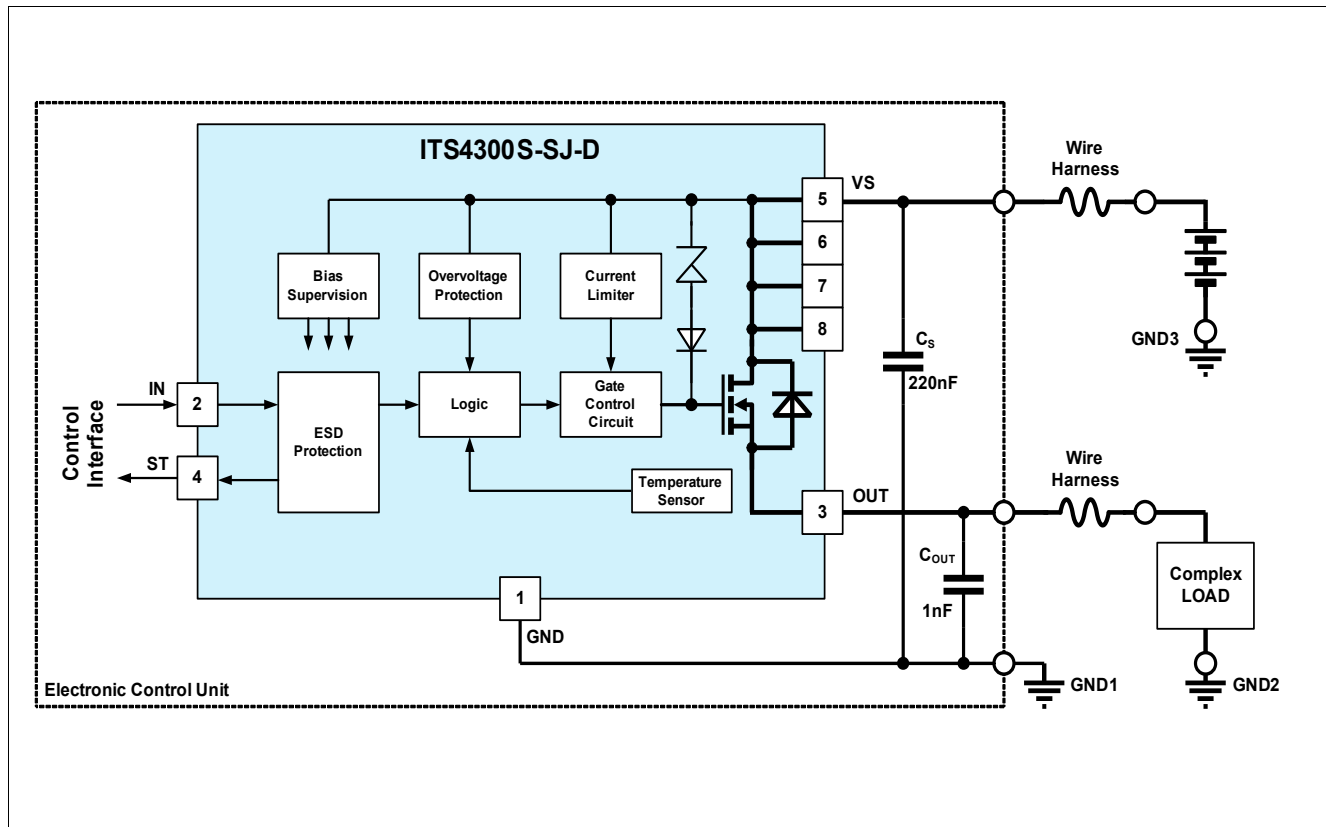

**Figure 4 Application diagram**

The ITS4300S-SJ-D can be connected directly to a supply network. It is recommended to place a ceramic capacitor (e.g.  $C_s = 220\text{nF}$ ) between supply and GND to avoid line disturbances. Wire harness inductors/resistors are sketched in the application circuit above.

The complex load (resistive, capacitive or inductive) must be connected to the output pin OUT.

A built-in current limit protects the device against destruction.

The ITS4300S-SJ-D can be switched on and off with standard logic ground related logic signal at pin IN.

In standby mode (IN=L) the ITS4300S-SJ-D is deactivated with very low current consumption.

The output voltage slope is controlled during on and off transition to minimize emissions. Only a small ceramic capacitor  $C_{OUT}=1\text{nF}$  is recommended to attenuate RF noise.

In the following chapters the main features, some typical waveforms and the protection behavior of the ITS4300S-SJ-D is shown. For further details please refer to application notes on the Infineon homepage.

**Application information**

**6.2 Diagnosis description**

For diagnostic purpose the device provides a digital output pin ST in order to indicate fault conditions.

The status output (ST) of the ITS4300S-SJ-D is a high voltage open drain output.

In “normal” operation mode the NMOS open drain transistor is switched OFF.

The following truth table defines the status output.

**Table 6 Truth table of diagnosis feature**

<b>Device operation</b>	<b>IN</b>	<b>OUT</b>	<b>ST</b>	<b>Comment</b>
Normal operation	H	H	H	
Short circuit to GND	L	L	H	No diagnosis
Short circuit to GND	H	L	L	OUT=L: $V_{OUT} < V_{OUTSC}$ ; Short circuit detection voltage; typ 2.8V
Short circuit to $V_S$ (in OFF state)	L	H	L	
Short circuit to $V_S$ (in ON state)	H	H	H	No diagnosis
Overload	L	L	H	No diagnosis
Overload	H	H	H	OUT=H: $V_{OUT} > V_{OUTSC}$ ; Short circuit detection voltage; typ 2.8V
Overtemperature	L	L	H	No diagnosis
Overtemperature	H	L	L	
Open load in OFF state	L	H	L	
Open load in OFF state	H	H	H	No diagnosis

Application information

6.3 Special feature description

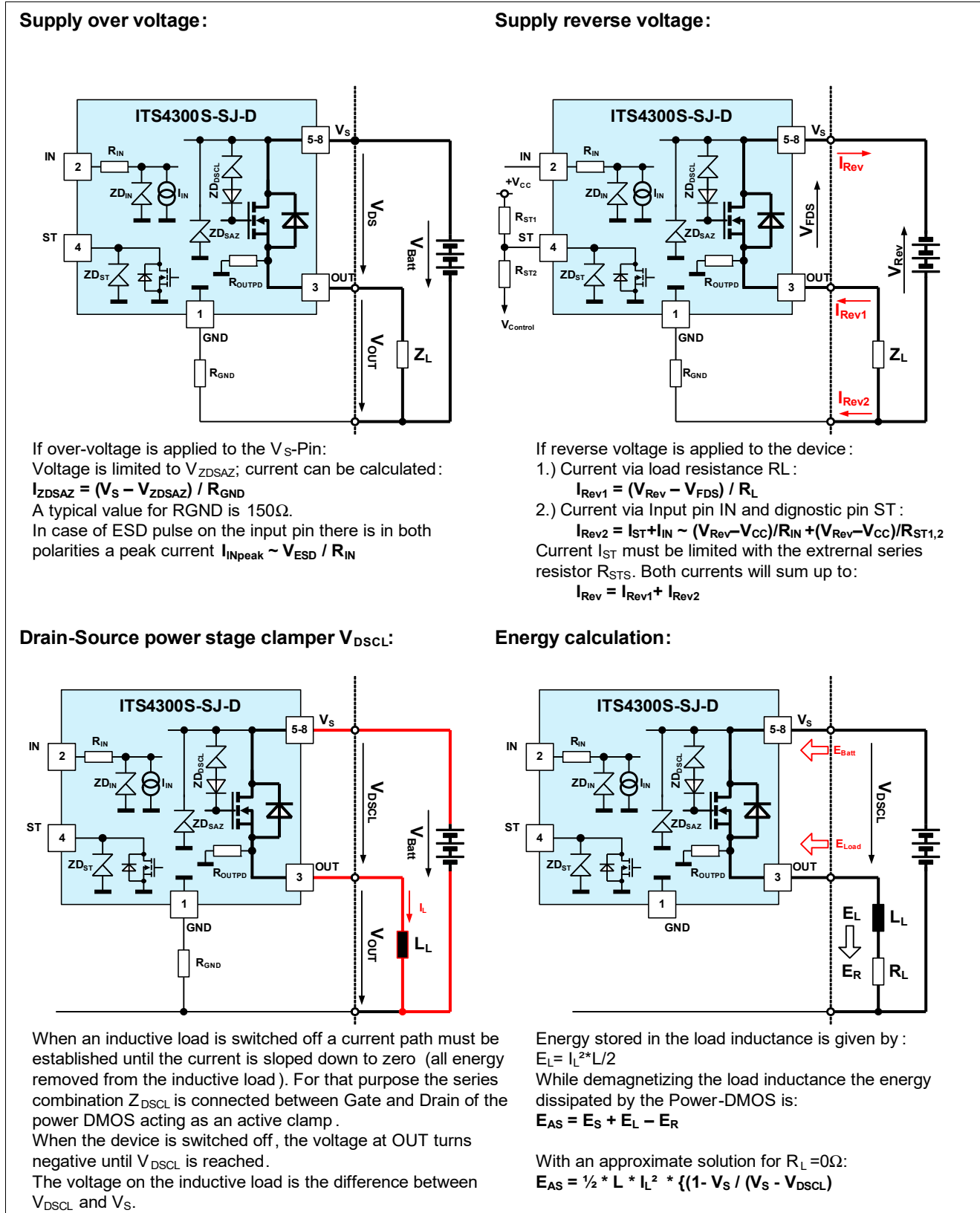

Figure 5 Special feature description

### 6.4 Typical application waveforms

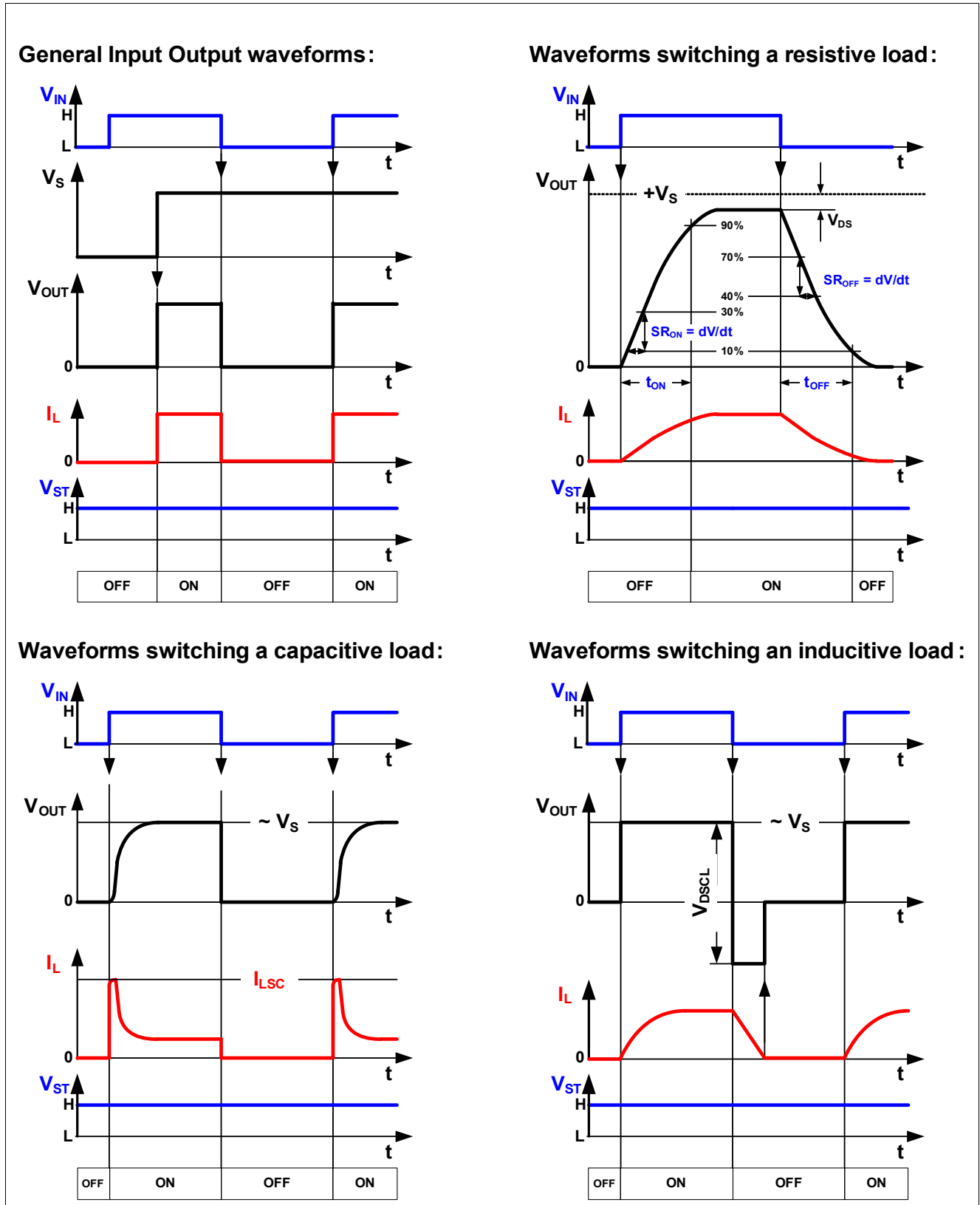

Figure 6 Typical application waveforms of the ITS4300S-SJ-D

### 6.5 Protection behavior

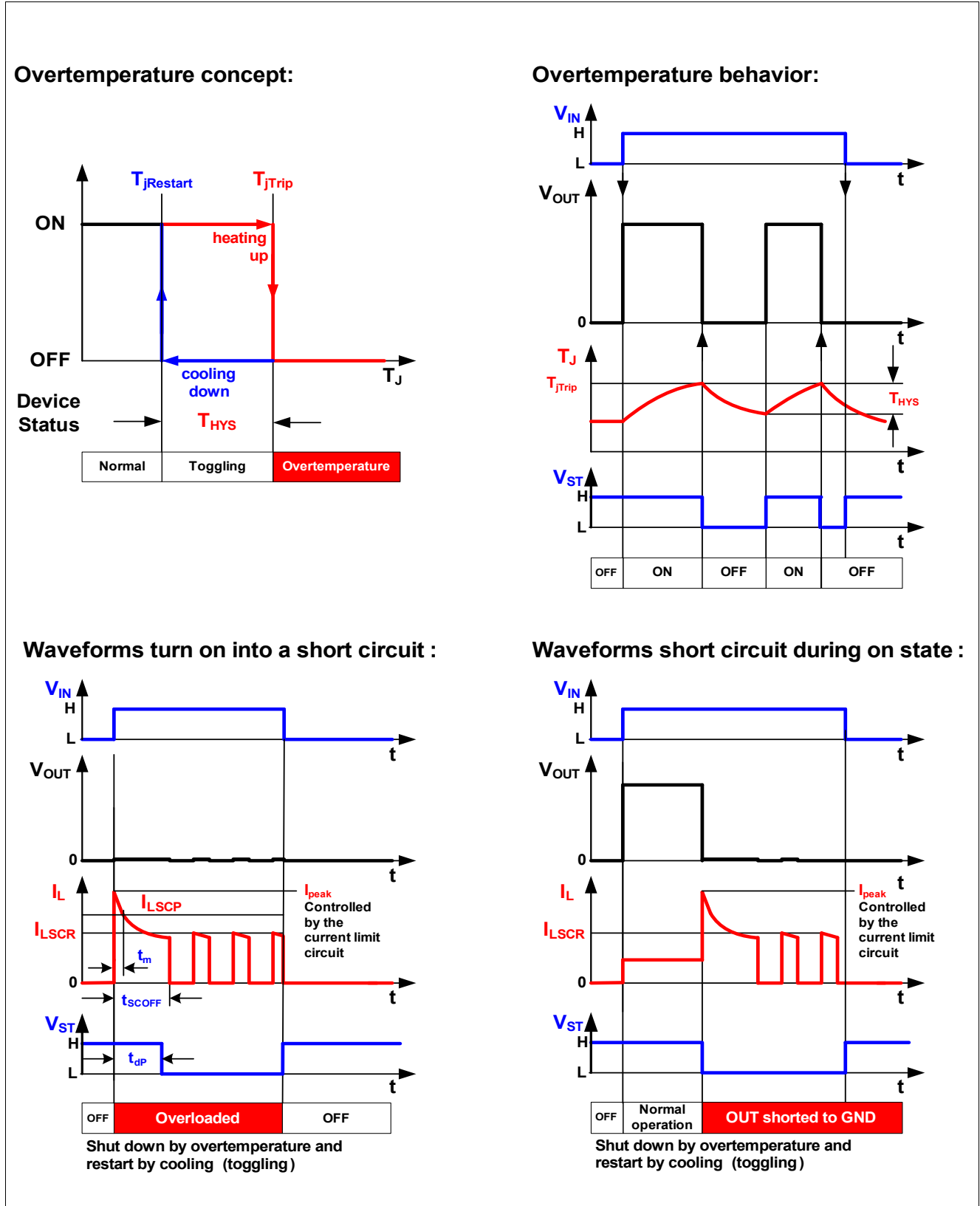

Figure 7 Protective behavior of the ITS4300S-SJ-D

Package information

7 Package information

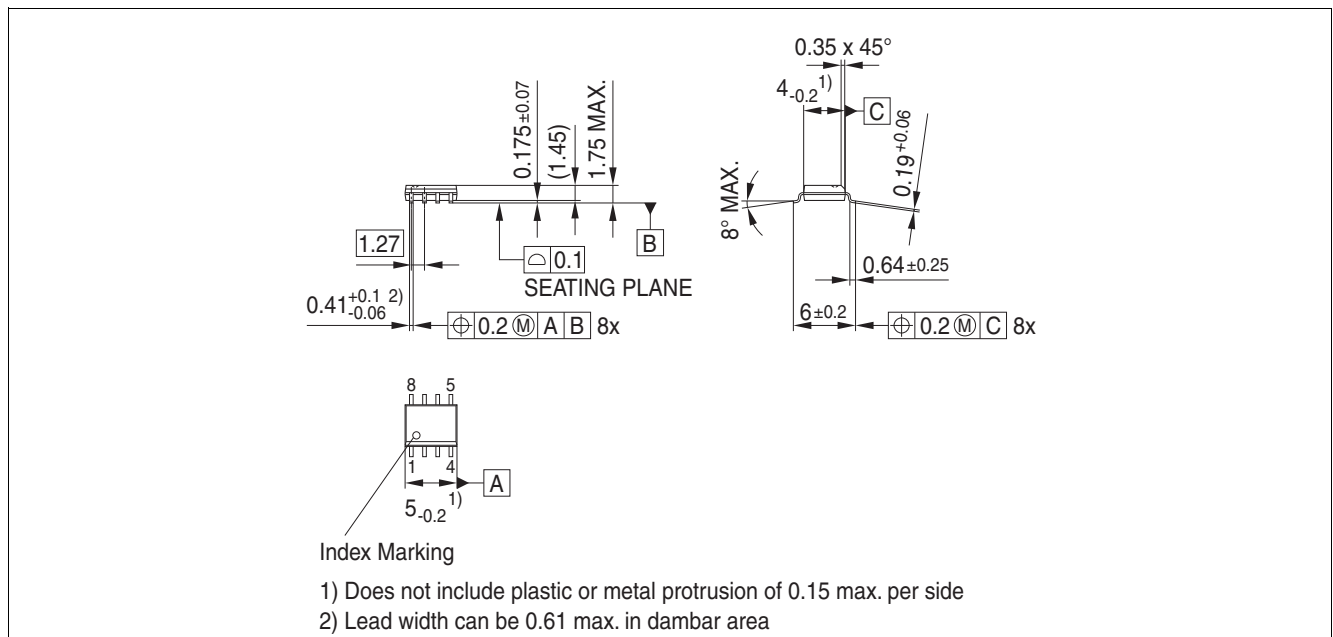

Figure 8 PG-DSO-8<sup>1)</sup>

Green Product (RoHS compliant)

To meet the world-wide customer requirements for environmentally friendly products and to be compliant with government regulations the device is available as a green product. Green products are RoHS-Compliant (i.e Pb-free finish on leads and suitable for Pb-free soldering according to IPC/JEDEC J-STD-020).

Further information on packages

<https://www.infineon.com/packages>

1) Dimensions in mm

Revision history

## 8 Revision history

Revision	Date	Changes
1.1	2019-07-25	Datasheet updated: - ESD ratings for HBM updated according to ANSI/ESDA/JEDEC JS-001 - Editorial changes
1.0	12-09-01	Datasheet release

## Trademarks

All referenced product or service names and trademarks are the property of their respective owners.

**Edition 2019-07-25**

**Published by**

**Infineon Technologies AG**

**81726 Munich, Germany**

**© 2019 Infineon Technologies AG.**

**All Rights Reserved.**

**Do you have a question about any aspect of this document?**

**Email: [erratum@infineon.com](mailto:erratum@infineon.com)**

**Z8F51106901**

## IMPORTANT NOTICE

The information given in this document shall in no event be regarded as a guarantee of conditions or characteristics ("Beschaffenheitsgarantie").

With respect to any examples, hints or any typical values stated herein and/or any information regarding the application of the product, Infineon Technologies hereby disclaims any and all warranties and liabilities of any kind, including without limitation warranties of non-infringement of intellectual property rights of any third party.

In addition, any information given in this document is subject to customer's compliance with its obligations stated in this document and any applicable legal requirements, norms and standards concerning customer's products and any use of the product of Infineon Technologies in customer's applications.

The data contained in this document is exclusively intended for technically trained staff. It is the responsibility of customer's technical departments to evaluate the suitability of the product for the intended application and the completeness of the product information given in this document with respect to such application.

For further information on technology, delivery terms and conditions and prices, please contact the nearest Infineon Technologies Office ([www.infineon.com](http://www.infineon.com)).

Please note that this product is not qualified according to the AEC Q100 or AEC Q101 documents of the Automotive Electronics Council.

## WARNINGS

Due to technical requirements products may contain dangerous substances. For information on the types in question please contact your nearest Infineon Technologies office.

Except as otherwise explicitly approved by Infineon Technologies in a written document signed by authorized representatives of Infineon Technologies, Infineon Technologies' products may not be used in any applications where a failure of the product or any consequences of the use thereof can reasonably be expected to result in personal injury.