

# NCV8605, NCV8606

## LDO Regulator - Low $I_{GND}$ , CMOS with/without Enable, Enhanced

### 500 mA

The NCV8605/NCV8606 provide in excess of 500 mA of output current at fixed voltage options or an adjustable output voltage from 5.0 V down to 1.25 V. These devices are designed for space constrained and portable battery powered applications and offer additional features such as high PSRR, low noise operation, short circuit and thermal protection. The devices are designed to be used with low cost ceramic capacitors and are packaged in the DFN6 3x3.3. NCV8605 is designed without enable pin, NCV8606 is designed with enable pin.

#### Features

- Output Voltage Options:  
Adjustable, 1.5 V, 1.8 V, 2.5 V, 2.8 V, 3.0 V, 3.3 V, 5.0 V
- Adjustable Output by External Resistors from 5.0 V down to 1.25 V
- Current Limit 675 mA
- Low  $I_{GND}$  (Independent of Load)
- $\pm 1.5\%$  Output Voltage Tolerance Over All Operating Conditions (Adjustable)
- $\pm 2\%$  Output Voltage Tolerance Over All Operating Conditions (Fixed)
- NCV8605 Fixed is Direct Replacement LP8345
- Typical Noise Voltage of  $50 \mu V_{rms}$  without a Bypass Capacitor
- Enhanced ESD Ratings: 4 kV Human Body Mode (HBM)  
200 V Machine Model (MM)
- NCV Prefix for Automotive and Other Applications Requiring Unique Site and Control Change Requirements; AEC-Q100 Qualified and PPAP Capable
- These are Pb-Free Devices

#### Typical Applications

- Hard Disk Drivers
- Notebook Computers
- Battery Power Electronics
- Portable Instrumentation

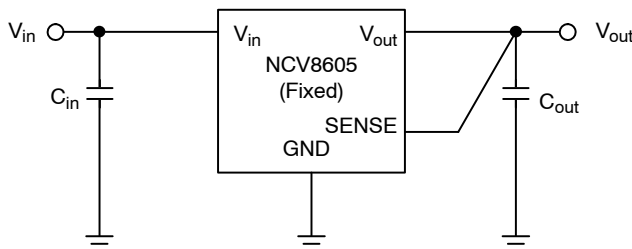

Figure 1. NCV8605 Typical Application Circuit for Fixed Version (1.5 V, 1.8 V, 2.5 V, 2.8 V, 3.0 V, 3.3 V, 5.0 V)



ON Semiconductor®

<http://onsemi.com>



DFN6  
MN SUFFIX  
CASE 506AX

#### PIN CONNECTIONS

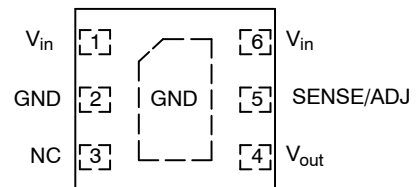

NCV8605, DFN6 3x3.3mm  
(Top View)

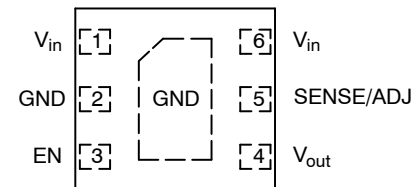

NCV8606, DFN6 3x3.3mm  
(Top View)

#### MARKING DIAGRAM

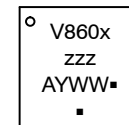

- x = 5 or 6
- ZZZ = ADJ, 150, 180, 250, 280, 300, 330, 500
- A = Assembly Location
- Y = Year
- WW = Work Week
- = Pb-Free Package

(\*Note: Microdot may be in either location)

#### ORDERING INFORMATION

See detailed ordering and shipping information in the package dimensions section on page 11 of this data sheet.

# NCV8605, NCV8606

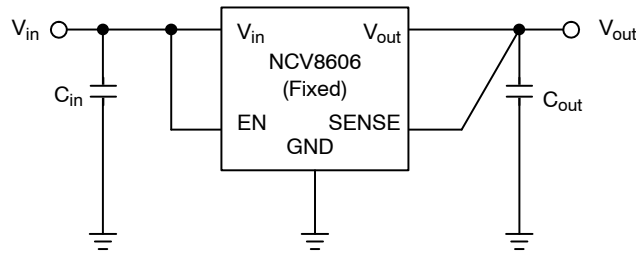

Figure 2. NCV8606 Typical Application Circuit for Fixed Version (1.5 V, 1.8 V, 2.5 V, 2.8 V, 3.0 V, 3.3 V, 5.0 V)

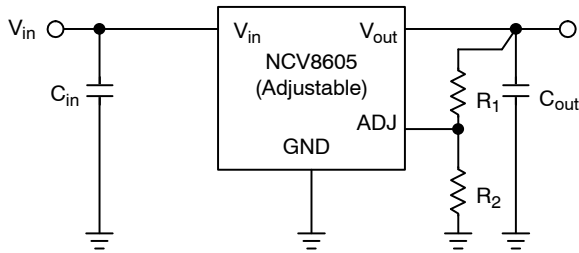

Figure 3. NCV8605 Typical Application Circuit for Adjustable Version ( $1.25\text{ V} < V_{\text{out}} \leq 5.0\text{ V}$ )

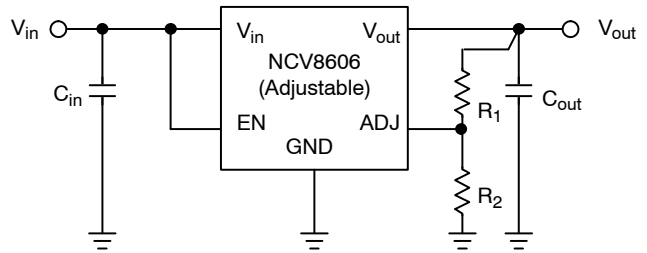

Figure 4. NCV8606 Typical Application Circuit for Adjustable Version ( $1.25\text{ V} < V_{\text{out}} \leq 5.0\text{ V}$ )

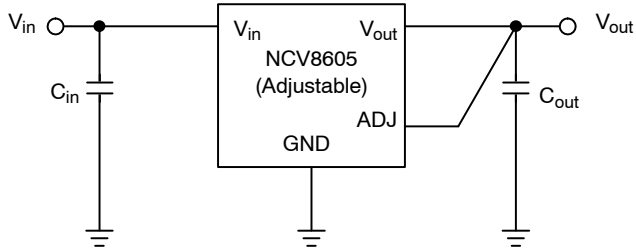

Figure 5. NCV8605 Typical Application Circuit for Adjustable Version ( $V_{\text{out}} = 1.25\text{ V}$ )

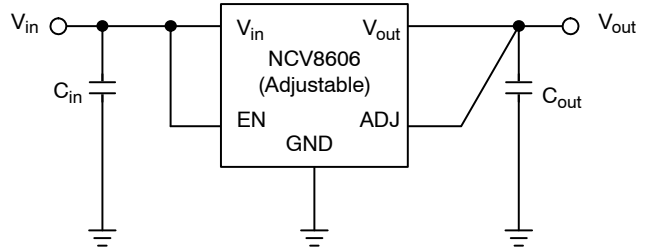

Figure 6. NCV8606 Typical Application Circuit for Adjustable Version ( $V_{\text{out}} = 1.25\text{ V}$ )

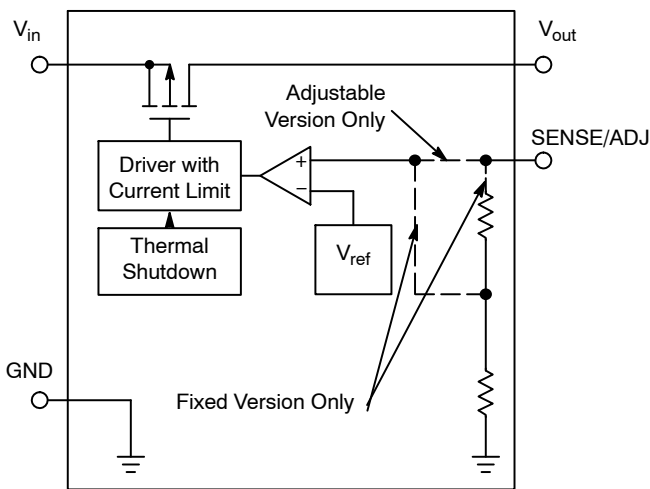

Figure 7. NCV8605 Simplified Block Diagram

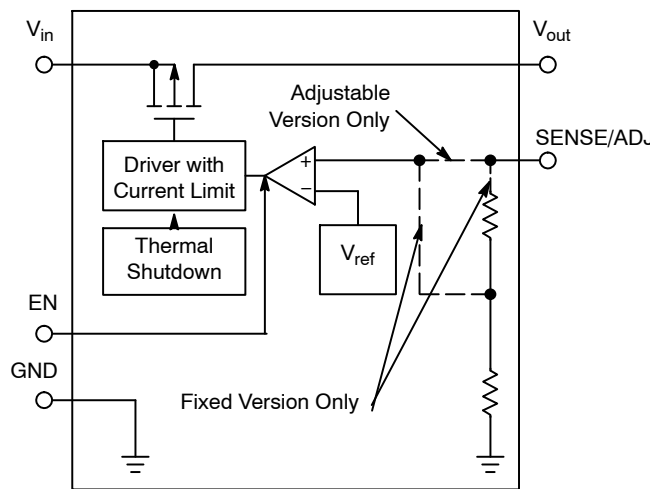

Figure 8. NCV8606 Simplified Block Diagram

# NCV8605, NCV8606

## PIN FUNCTION DESCRIPTION

Pin No.	Pin Name	Description
1	V <sub>in</sub>	Positive Power Supply Input*
2	GND	Power Supply Ground
3	NC/EN	NCV8605: This Pin is Not Connected NCV8606: This Pin is Enable Input, Active HIGH
4	V <sub>out</sub>	Regulated Output Voltage
5	SENSE/ADJ	Output Voltage Sense Input Fixed Version: Connect Directly to Output Capacitor Adjustable Version: Connect to Middle Point of External Resistor Divider
6	V <sub>in</sub>	Positive Power Supply Input*
EPAD	GND	Exposed Pad is Connected to Ground

\*Pins 1 and 6 must be connected together externally for output current full range operation

## ABSOLUTE MAXIMUM RATINGS

Rating	Symbol	Value	Unit
Input Voltage Range (Note 1)	V <sub>in</sub>	-0.3 to 6.5	V
Chip Enable Voltage Range (NCV8606 only)	V <sub>EN</sub>	-0.3 to 6.5	V
Output Voltage Range	V <sub>out</sub>	-0.3 to 6.5	V
Output Voltage/Sense Input Range, SENSE/ADJ	V <sub>ADJ</sub>	-0.3 to 6.5	V
ESD Capability Human Body Model Machine Model	ESD	4000 200	V
Maximum Junction Temperature	T <sub>J(MAX)</sub>	150	°C
Storage Temperature Range	T <sub>STG</sub>	-65 to 150	°C

Stresses exceeding Maximum Ratings may damage the device. Maximum Ratings are stress ratings only. Functional operation above the Recommended Operating Conditions is not implied. Extended exposure to stresses above the Recommended Operating Conditions may affect device reliability.

NOTE: This device series contains ESD Protection and exceeds the following tests:

ESD Human Body Model tested per AEC-Q100-002 (EIA/JESD22-A114)

ESD Machine Model tested per AEC-150 mA per JEDEC standard: JESD78Q100-003 (EIA/JESD22-A115)

Latchup Current Maximum Rating: ≤ 150 mA per JEDEC standard: JESD78.

1. Minimum V<sub>in</sub> = (V<sub>out</sub> + V<sub>DO</sub>) or 1.5 V, whichever is higher.

## THERMAL CHARACTERISTICS

Rating	Symbol	Value	Unit
Thermal Resistance, Junction-to-Ambient (Note 2)	R <sub>θJA</sub>	75	°C/W
Thermal Resistance, Junction-to-Case	R <sub>ψJC</sub>	18	°C/W

2. Soldered on 645 mm<sup>2</sup>, 1 oz copper area, FR4. Refer to ELECTRICAL CHARACTERISTICS and APPLICATION INFORMATION for Safe Operating Area.

## OPERATING RANGES (Note 3)

Rating	Symbol	Value	Unit
Input Voltage (Note 4)	V <sub>in</sub>	1.5 to 6.0	V
Output Current (Notes 5 and 6)	I <sub>out</sub>	0 to 675	mA
Junction Temperature	T <sub>J</sub>	-40 to 150	°C
Ambient Temperature	T <sub>A</sub>	-40 to 125	°C

3. Refer to Electrical Characteristics and Application Information for Safe Operating Area.

4. Minimum V<sub>in</sub> = (V<sub>out</sub> + V<sub>DO</sub>) or 1.5 V, whichever is higher.

5. Minimum limit valid for fixed versions only. For more details refer to Application Information Section.

6. Maximum limit for V<sub>out</sub> = V<sub>out(nom)</sub> - 10%.

# NCV8605, NCV8606

## ELECTRICAL CHARACTERISTICS

( $V_{in} = (V_{out} + 0.5 \text{ V})$  or 1.5 V, whichever is higher,  $C_{in} = 1 \mu\text{F}$ ,  $C_{out} = 1 \mu\text{F}$ , for typical values  $T_A = 25^\circ\text{C}$ , for min/max values  $T_A = -40^\circ\text{C}$  to  $85^\circ\text{C}$ ; unless otherwise noted.) (Notes 9 and 10)

Parameter	Test Conditions	Symbol	Min	Typ	Max	Unit
Output voltage (Adjustable Version)	$V_{in} = 1.75 \text{ V to } 6 \text{ V}$ $I_{out} = 1 \text{ mA to } 500 \text{ mA}$	$V_{out}$	1.231 (-1.5%)	1.250	1.269 (+1.5%)	V
Output voltage (Fixed Versions)	$V_{in} = (V_{out} + 0.5 \text{ V}) \text{ to } 6 \text{ V}$ $I_{out} = 1 \text{ mA to } 500 \text{ mA}$	$V_{out}$	1.470 1.764 2.450 2.744 2.940 3.234 4.900 (-2%)	1.5 1.8 2.5 2.8 3.0 3.3 5.0	1.530 1.836 2.550 2.856 3.060 3.366 5.100 (+2%)	V
Line regulation	$V_{in} = (V_{out} + 0.5 \text{ V}) \text{ to } 6 \text{ V}$ , $I_{out} = 1 \text{ mA}$	$Reg_{line}$	-	4	10	mV
Load regulation	$I_{out} = 1 \text{ mA to } 500 \text{ mA}$	$Reg_{load}$	-	10	30	mV
Dropout voltage (Adjustable Version) (Note 9)	$V_{DO} = V_{in} - V_{out}$ $V_{out} = 1.25 \text{ V}$ $I_{out} = 500 \text{ mA}$	$V_{DO}$	-	450	470	mV
Dropout voltage (Fixed Version)	$V_{DO} = V_{in} - (V_{out} - 0.1 \text{ V})$ $I_{out} = 500 \text{ mA}$ $V_{out} = 0 \text{ V to } 90\% V_{out(nom)}$	$V_{DO}$	-	290 250 200 190 180 170 150	360 300 250 240 230 220 200	mV
Disable Current (NCV8606 Only) (Note 10)	$V_{EN} = 0 \text{ V}$	$I_{DIS}$	-	0.1	1	$\mu\text{A}$
Ground Current	$I_{out} = 1 \text{ mA to } 500 \text{ mA}$	$I_{GND}$	-	145	180	$\mu\text{A}$
Current Limit (Note 11)	$V_{out} = V_{out(nom)} - 10\%$	$I_{LIM}$	675	-	-	mA
Output Short Circuit Current	$V_{out} = 0 \text{ V}$	$I_{SC}$	700	1000	1350	mA
Enable Input Threshold Voltage (NCV8606 Only) Voltage Increasing, Logic High Voltage Decreasing, Logic Low	High Low	$V_{th(EN)}$	0.9 -	- -	- 0.4	V
Turn-on Time (Note 11)	$V_{in} = 0 \text{ V to } (V_{out} + 0.5 \text{ V})$ or 1.75 V, whichever is higher $V_{out} = 0 \text{ V to } 90\%$ of $V_{out(nom)}$	$t_{on}$	-	6 6 7 8 10 12 15 30	- - - - - - - -	$\mu\text{s}$
Enable Time (NCV8606 Only) (Note 11)	$V_{EN} = \text{From } 0 \text{ V to } V_{in}$	$t_{EN}$	-	12 12 13 16 18 19 20 30	- - - - - - - -	$\mu\text{s}$

7. Refer to ABSOLUTE MAXIMUM RATINGS and APPLICATION INFORMATION for Safe Operating Area.
8. Performance guaranteed over the indicated operating temperature range by design and/or characterization tested at  $T_J = T_A = 25^\circ\text{C}$ . Low duty cycle pulse techniques are used during testing to maintain the junction temperature as close to ambient as possible.
9. Maximum dropout voltage is limited to minimum input voltage  $V_{in} = 1.7 \text{ V}$  recommended for guaranteed operation at maximum output current.
10. Refer to application information section.
11. Values based on design and/or characterization.

## NCV8605, NCV8606

### ELECTRICAL CHARACTERISTICS (continued)

( $V_{in} = (V_{out} + 0.5 \text{ V})$  or 1.5 V, whichever is higher,  $C_{in} = 1 \mu\text{F}$ ,  $C_{out} = 1 \mu\text{F}$ , for typical values  $T_A = 25^\circ\text{C}$ , for min/max values  $T_A = -40^\circ\text{C}$  to  $85^\circ\text{C}$ ; unless otherwise noted.) (Notes 9 and 10)

Parameter	Test Conditions	Symbol	Min	Typ	Max	Unit
Power Supply Ripple Rejection (Note 11)	$I_{out} = 500 \text{ mA}$ $V_{out} = 1.25 \text{ V}$ $V_{in} - V_{out} = 1 \text{ V}$ $f = 120 \text{ Hz}, 0.5 V_{PP}$ $f = 1 \text{ kHz}, 0.5 V_{PP}$ $f = 10 \text{ kHz}, 0.5 V_{PP}$	PSRR	–	62 55 40	–	dB
Output Noise Voltage (Note 11)	$f = 10 \text{ Hz to } 100 \text{ kHz}, V_{out} = 1.25 \text{ V}$	$V_n$	–	50	–	$\mu\text{V}_{rms}$
Thermal Shutdown Temperature (Note 11)		$T_{SD}$	–	175	–	$^\circ\text{C}$
Thermal Shutdown Hysteresis (Note 11)		$T_{SH}$	–	10	–	$^\circ\text{C}$

7. Refer to ABSOLUTE MAXIMUM RATINGS and APPLICATION INFORMATION for Safe Operating Area.
8. Performance guaranteed over the indicated operating temperature range by design and/or characterization tested at  $T_J = T_A = 25^\circ\text{C}$ . Low duty cycle pulse techniques are used during testing to maintain the junction temperature as close to ambient as possible.
9. Maximum dropout voltage is limited to minimum input voltage  $V_{in} = 1.7 \text{ V}$  recommended for guaranteed operation at maximum output current.
10. Refer to application information section.
11. Values based on design and/or characterization.

TYPICAL CHARACTERISTICS

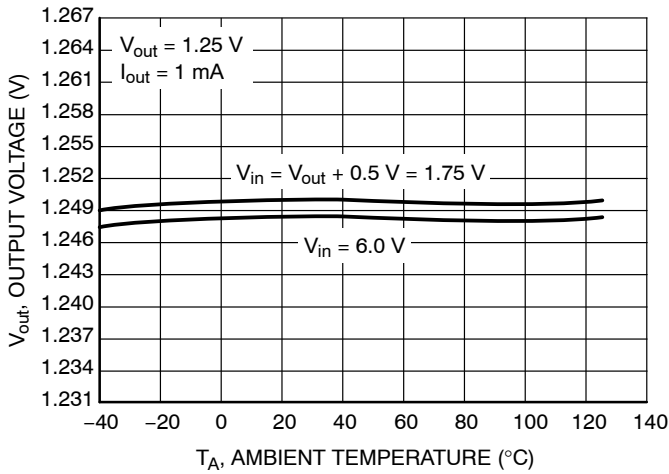

Figure 9. Output Voltage vs. Temperature  
( $V_{out} = 1.25\text{ V}$ )

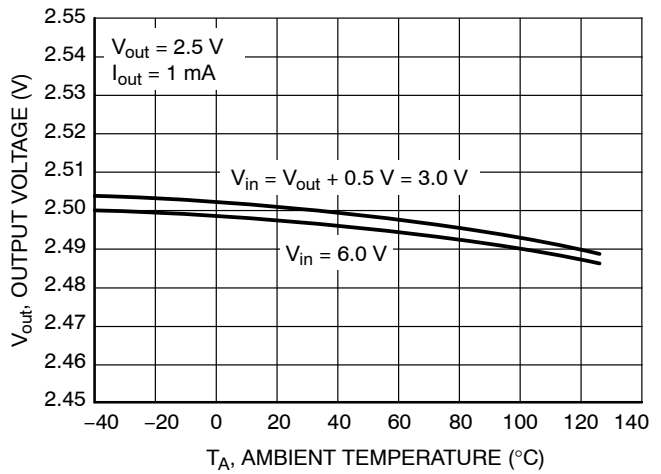

Figure 10. Output Voltage vs. Temperature  
( $V_{out} = 2.5\text{ V}$ )

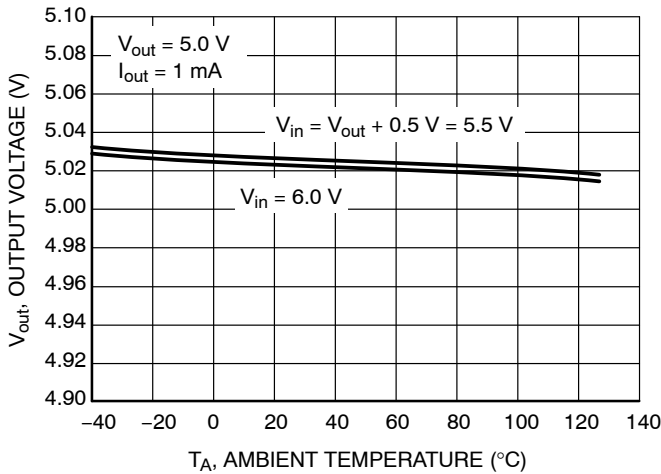

Figure 11. Output Voltage vs. Temperature  
( $V_{out} = 5.0\text{ V}$ )

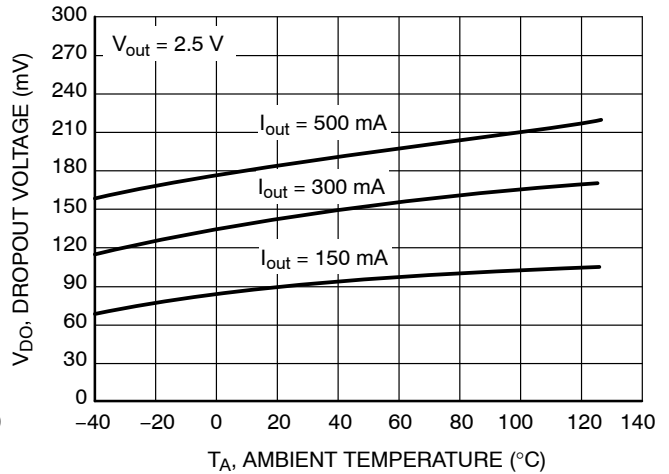

Figure 12. Dropout Voltage vs. Temperature  
( $V_{out} = 2.5\text{ V}$ )

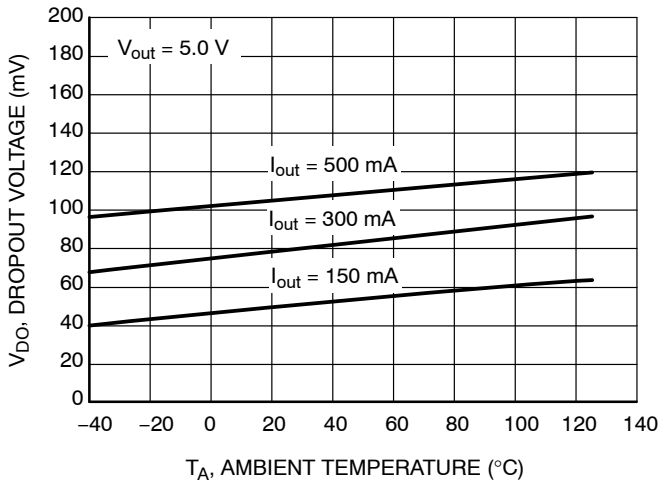

Figure 13. Dropout Voltage vs. Temperature  
( $V_{out} = 5.0\text{ V}$ )

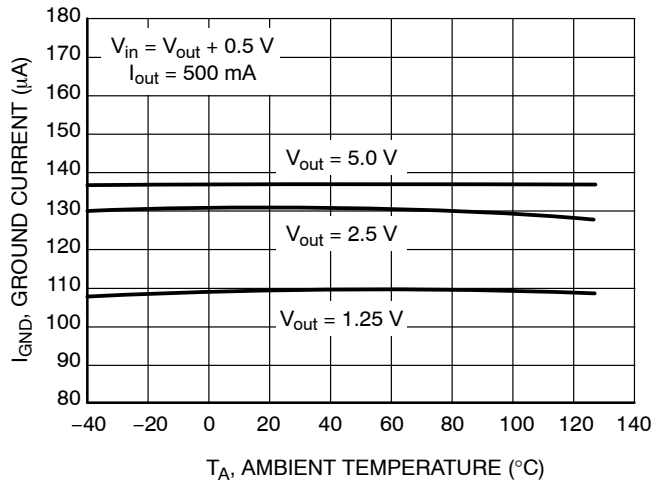

Figure 14. Ground Current vs. Temperature

TYPICAL CHARACTERISTICS

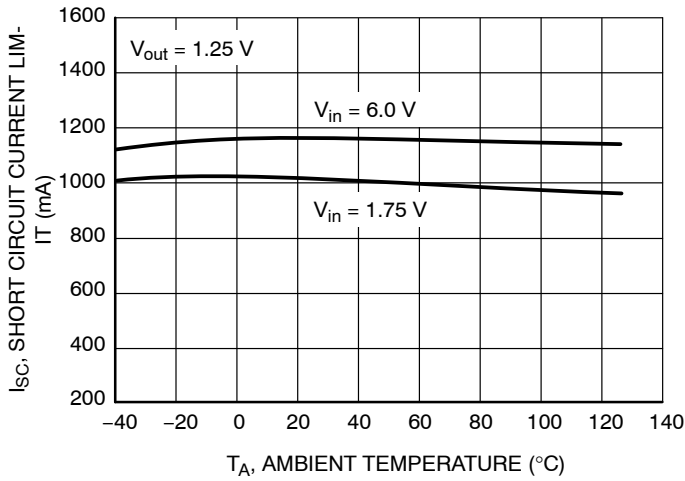

Figure 15. Short Circuit Current Limit vs. Temperature ( $V_{out} = 1.25\text{ V}$ )

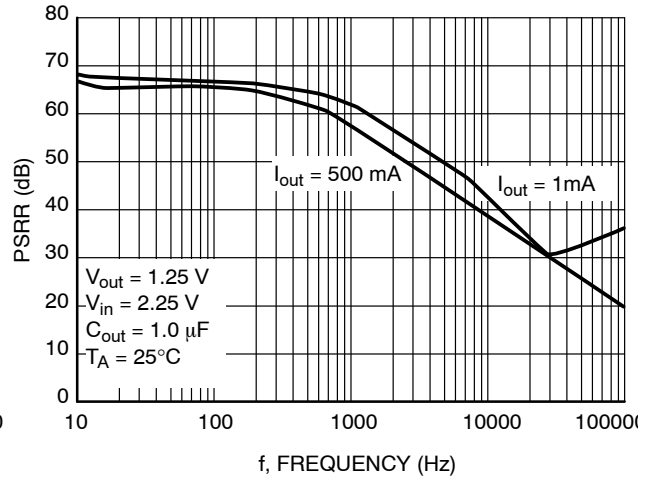

Figure 16. PSRR vs. Frequency ( $V_{out} = 1.25\text{ V}$ )

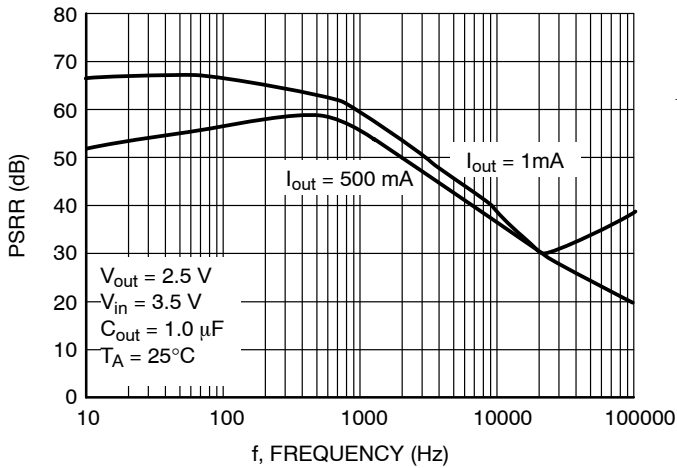

Figure 17. PSRR vs. Frequency ( $V_{out} = 2.5\text{ V}$ )

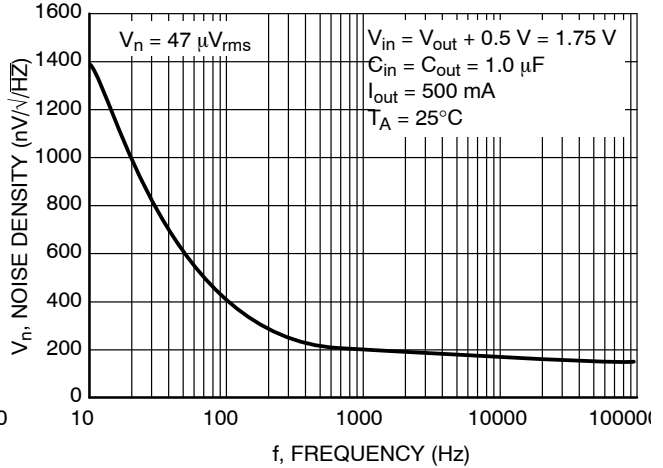

Figure 18. Noise Density vs. Frequency ( $V_{out} = 1.25\text{ V}$ )

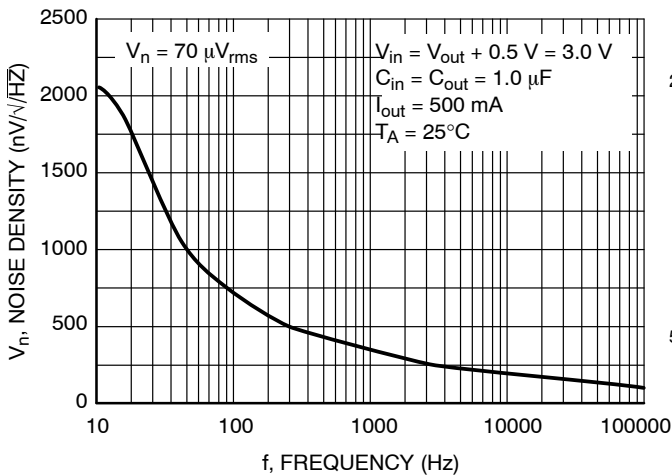

Figure 19. Noise Density vs. Frequency ( $V_{out} = 2.5\text{ V}$ )

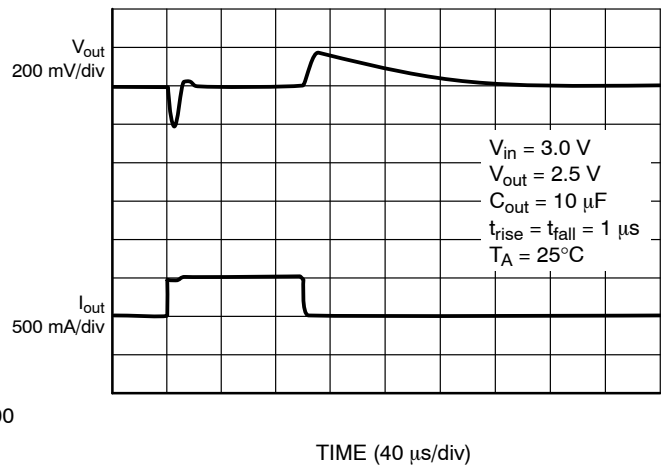

Figure 20. Load Transient ( $V_{out} = 2.5\text{ V}$ )

TYPICAL CHARACTERISTICS

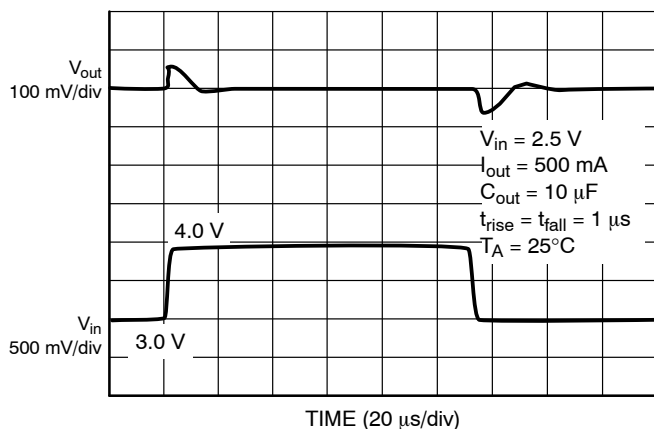

Figure 21. Line Transient ( $V_{out} = 2.5\text{ V}$ )

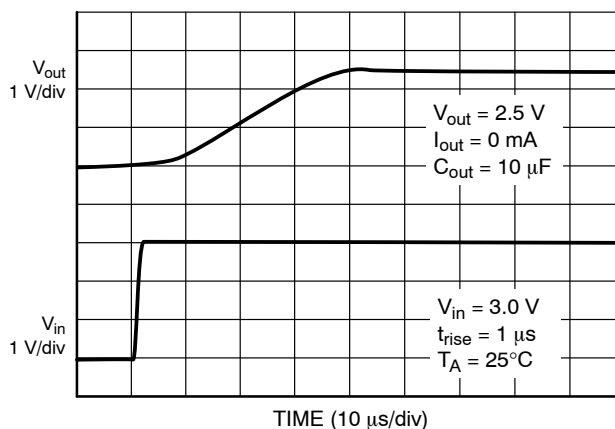

Figure 22. Startup Transient ( $V_{out} = 2.5\text{ V}$ )

DEFINITIONS

**General**

All measurements are performed using short pulse low duty cycle techniques to maintain junction temperature as close as possible to ambient temperature.

**Line Regulation**

The change in output voltage for a change in input voltage. The measurement is made under conditions of low dissipation or by using pulse techniques such that the average junction temperature is not significantly affected.

**Load Regulation**

The change in output voltage for a change in output load current at a constant temperature.

**Dropout Voltage**

The input to output differential at which the regulator output no longer maintains regulation against further reductions in input voltage. Measured when the output drops 100 mV below its nominal value. The junction temperature, load current, and minimum input supply requirements affect the dropout level.

**Ground and Disable Currents**

Ground Current is the current that flows through the ground pin when the regulator operates without a load on its output ( $I_{GND}$ ). This consists of internal IC operation, bias, etc. It is actually the difference between the input current (measured through the LDO input pin) and the output load current. If the regulator has an input pin that reduces its internal bias and shuts off the output (enable/disable function), this term is called the disable current ( $I_{DIS}$ ).

**Current Limit and Short Circuit Current Limit**

Current Limit is value of output current by which output voltage drops by 10% with respect to its nominal value.

Short Circuit Current Limit is output current value measured with output of the regulator shorted to ground.

**PSRR**

Power Supply Rejection Ratio is defined as ratio of output voltage and input voltage ripple. It is measured in decibels (dB).

**Output Noise Voltage**

This is the integrated value of the output noise over a specified frequency range. Input voltage and output load current are kept constant during the measurement. Results are expressed in  $\mu V_{rms}$  or  $nV / \sqrt{Hz}$ .

**Turn-on and Turn-off Times**

Turn-on Time is time difference measured during power-up of the device from the moment when input voltage reaches 90% of its operating value to the moment when output voltage reaches 90% of its nominal value at specific output current or resistive load.

Turn-off Time is time difference measured during power-down of the device from the moment when input voltage drops to 10% of its operating value to the moment when output voltage drops to 10% of its nominal value at specific output current or resistive load.

**Enable and Disable Times**

Enable Time is time difference measured during power-up of the device from the moment when enable voltage reaches 90% of input voltage operating value to the moment when output voltage reaches 90% of its nominal value at specific output current or resistive load.

Disable Time is time difference measured during power-down of the device from the moment when enable voltage drops to 10% of input voltage operating value to the



## NCV8605, NCV8606

moment when output voltage drops to 10% of its nominal value at specific output current or resistive load.

### Line Transient Response

Typical output voltage overshoot and undershoot response when the input voltage is excited with a given slope.

### Load Transient Response

Typical output voltage overshoot and undershoot response when the output current is excited with a given slope between no-load and full-load conditions.

### Thermal Protection

Internal thermal shutdown circuitry is provided to protect the integrated circuit in the event that the maximum junction temperature is exceeded. When activated at typically 175°C, the regulator turns off. This feature is provided to prevent failures from accidental overheating.

### Maximum Package Power Dissipation

The power dissipation level at which the junction temperature reaches its maximum operating value.

## APPLICATIONS INFORMATION

The NCV8605/NCV8606 regulator is self-protected with internal thermal shutdown and internal current limit. Typical application circuits are shown in Figures 1 to 4.

### Input Decoupling ( $C_{in}$ )

A ceramic or tantalum 1.0  $\mu\text{F}$  capacitor is recommended and should be connected close to the NCV8605/NCV8606 package. Higher capacitance and lower ESR will improve the overall line transient response.

### Output Decoupling ( $C_{out}$ )

The NCV8605/NCV8606 is a stable component and does not require a minimum Equivalent Series Resistance (ESR) for the output capacitor. The minimum output decoupling value is 1.0  $\mu\text{F}$  and can be augmented to fulfill stringent load transient requirements. The regulator works with ceramic chip capacitors as well as tantalum devices. Larger values improve noise rejection and load regulation transient response. Typical characteristics were measured with Murata ceramic capacitors. GRM219R71E105K (1  $\mu\text{F}$ , 25 V, X7R, 0805) and GRM21BR71A106K (10  $\mu\text{F}$ , 10 V, X7R, 0805).

### No-Load Regulation Considerations

The NCV8605/NCV8606 adjustable regulator will operate properly under conditions where the only load current is through the resistor divider that sets the output voltage. However, in the case where the NCV8605/NCV8606 is configured to provide a 1.250 V output, there is no resistor divider. If the part is enabled under no-load conditions, leakage current through the pass transistor at junction temperatures above 85°C can approach several microamps, especially as junction temperature approaches 150°C. If this leakage current is not directed into a load, the output voltage will rise up to a level approximately 20 mV above nominal.

The NCV8605/ NCV8606 contains an overshoot clamp circuit to improve transient response during a load current step release. When output voltage exceeds the nominal by approximately 20 mV, this circuit becomes active and clamps the output from further voltage increase. Tying the ENABLE pin to  $V_{in}$  (NCV8606 only) will ensure that the part is active whenever the supply voltage is present, thus

guaranteeing that the clamp circuit is active whenever leakage current is present.

When the NCV8606 adjustable regulator is disabled, the overshoot clamp circuit becomes inactive and the pass transistor leakage will charge any capacitance on  $V_{out}$ . If no load is present, the output can charge up to within a few millivolts of  $V_{in}$ . In most applications, the load will present some impedance to  $V_{out}$  such that the output voltage will be inherently clamped at a safe level. A minimum load of 10  $\mu\text{A}$  is recommended.

Unlike LP8345, for NCV8605/606 fixed voltage versions there is no limitation for minimum load current.

### Noise Decoupling

The NCV8605/NCV8606 is a low noise regulator and needs no external noise reduction capacitor. Unlike other low noise regulators which require an external capacitor and have slow startup times, the NCV8605/NCV8606 operates without a noise reduction capacitor, has a typical 8  $\mu\text{s}$  turn-on time and achieves a 50  $\mu\text{V}_{\text{rms}}$  overall noise level between 10 Hz and 100 kHz.

### Enable Operation (NCV8606 Only)

The enable pin will turn the regulator on or off. The threshold limits are covered in the electrical characteristics table in this data sheet. The turn-on/turn-off transient voltage being supplied to the enable pin should exceed a slew rate of 10 mV/ $\mu\text{s}$  to ensure correct operation. If the enable function is not to be used then the pin should be connected to  $V_{in}$ .

### Output Voltage Adjust

The output voltage can be adjusted from 1 times (Figure 4) to 4 times (Figure 3) the typical 1.250 V regulation voltage via the use of resistors between the output and the ADJ input. The output voltage and resistors are chosen using Equation 1 and Equation 2.

$$V_{out} = 1.250 \left( 1 + \frac{R_1}{R_2} \right) + (I_{ADJ} \times R_1) \quad (\text{eq. 1})$$

$$R_2 \cong \frac{R_1}{\frac{V_{out}}{1.25} - 1} \quad (\text{eq. 2})$$

## NCV8605, NCV8606

Input bias current  $I_{ADJ}$  is typically less than 150 nA. Choose  $R_1$  arbitrarily to minimize errors due to the bias current and to minimize noise contribution to the output voltage. Use Equation 2 to find the required value for  $R_2$ .

### Thermal

As power in the NCV8605/NCV8606 increases, it might become necessary to provide some thermal relief. The maximum power dissipation supported by the device is dependent upon board design and layout. Mounting pad configuration on the PCB, the board material, and the ambient temperature affect the rate of junction temperature rise for the part. When the NCV8605/NCV8606 has good thermal conductivity through the PCB, the junction temperature will be relatively low with high power applications. The maximum dissipation the NCV8605/NCV8606 can handle is given by:

$$P_{D(MAX)} = \frac{[T_{J(MAX)} - T_A]}{R_{\theta JA}} \quad (\text{eq. 3})$$

Since  $T_J$  is not recommended to exceed 125°C ( $T_{J(MAX)}$ ), then the NCV8605/NCV8606 soldered on 645 mm<sup>2</sup>, 1 oz copper area, FR4 can dissipate up to 1.3 W when the ambient temperature ( $T_A$ ) is 25°C. See Figure 23 for  $R_{\theta JA}$  versus PCB area.

The power dissipated by the NCV8605/NCV8606 can be calculated from the following equations:

$$P_D \approx V_{in}(I_{GND} + I_{OUT}) + I_{out}(V_{in} - V_{out}) \quad (\text{eq. 4})$$

or

$$V_{in(MAX)} \approx \frac{P_{D(MAX)} + (V_{out} \times I_{out})}{I_{out} + I_{GND}} \quad (\text{eq. 5})$$

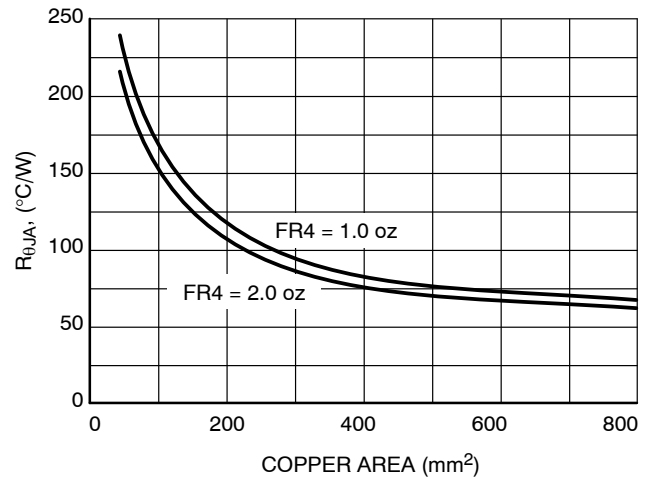

Figure 23. Thermal Resistance vs. Copper Area

### Hints

$V_{in}$  and GND printed circuit board traces should be as wide as possible. When the impedance of these traces is high, there is a chance to pick up noise or cause the regulator to malfunction. Place external components, especially the output capacitor, as close as possible to the NCV8605/NCV8606, and make traces as short as possible.

## NCV8605, NCV8606

### ORDERING INFORMATION

Device*	Nominal Output Voltage (V)	Marking	Package	Shipping†
NCV8605MNADJT2G	ADJ	V8605 ADJ	DFN6 (Pb-Free)	3000 / Tape & Reel
NCV8605MN15T2G	1.5	V8605 150	DFN6 (Pb-Free)	3000 / Tape & Reel
NCV8605MN18T2G	1.8	V8605 180	DFN6 (Pb-Free)	3000 / Tape & Reel
NCV8605MN25T2G	2.5	V8605 250	DFN6 (Pb-Free)	3000 / Tape & Reel
NCV8605MN28T2G	2.8	V8605 280	DFN6 (Pb-Free)	3000 / Tape & Reel
NCV8605MN30T2G	3.0	V8605 300	DFN6 (Pb-Free)	3000 / Tape & Reel
NCV8605MN33T2G	3.3	V8605 330	DFN6 (Pb-Free)	3000 / Tape & Reel
NCV8605MN50T2G	5.0	V8605 500	DFN6 (Pb-Free)	3000 / Tape & Reel
NCV8606MNADJT2G	ADJ	V8606 ADJ	DFN6 (Pb-Free)	3000 / Tape & Reel
NCV8606MN15T2G	1.5	V8606 150	DFN6 (Pb-Free)	3000 / Tape & Reel
NCV8606MN18T2G	1.8	V8606 180	DFN6 (Pb-Free)	3000 / Tape & Reel
NCV8606MN25T2G	2.5	V8606 250	DFN6 (Pb-Free)	3000 / Tape & Reel
NCV8606MN28T2G	2.8	V8606 280	DFN6 (Pb-Free)	3000 / Tape & Reel
NCV8606MN30T2G	3.0	V8606 300	DFN6 (Pb-Free)	3000 / Tape & Reel
NCV8606MN33T2G	3.3	V8606 330	DFN6 (Pb-Free)	3000 / Tape & Reel
NCV8606MN50T2G	5.0	V8606 500	DFN6 (Pb-Free)	3000 / Tape & Reel

†For information on tape and reel specifications, including part orientation and tape sizes, please refer to our Tape and Reel Packaging Specifications Brochure, BRD8011/D.

\*NCV Prefix for Automotive and Other Applications Requiring Unique Site and Control Change Requirements; AEC-Q100 Qualified and PPAP Capable

# MECHANICAL CASE OUTLINE

## PACKAGE DIMENSIONS

ON Semiconductor®

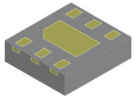

### DFN6 3.0x3.3, 0.95P

#### CASE 506AX

#### ISSUE A

DATE 22 SEP 2020

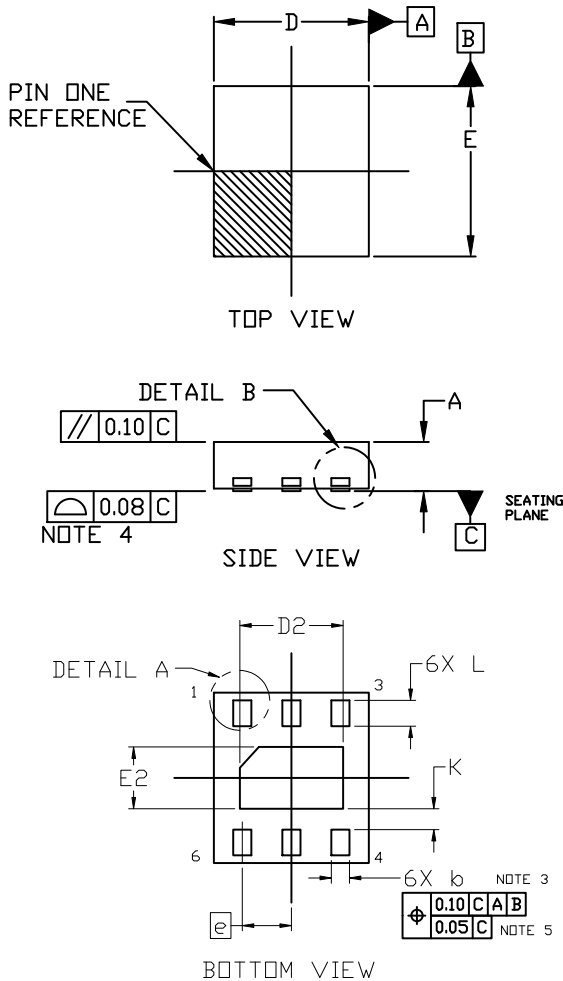

- NOTES:
1. DIMENSIONING AND TOLERANCING PER ASME Y14.5M, 2009.
  2. CONTROLLING DIMENSION: MILLIMETERS
  3. DIMENSION *b* APPLIES TO PLATED TERMINALS AND IS MEASURED BETWEEN 0.15 AND 0.30MM FROM THE TERMINAL TIP.
  4. COPLANARITY APPLIES TO THE EXPOSED PAD AS WELL AS THE TERMINALS.
  5. POSITIONAL TOLERANCE APPLIES TO THE EXPOSED PAD AS WELL AS THE TERMINALS.

DIM	MILLIMETERS		
	MIN.	NOM.	MAX.
A	0.80	0.90	1.00
A1	0.00	---	0.05
b	0.30	0.35	0.40
D	2.90	3.00	3.10
D2	1.90	2.00	2.10
E	3.20	3.30	3.40
E2	1.10	1.20	1.30
e	0.95 BSC		
K	0.40 REF		
L	0.40	0.50	0.60
L1	0.00	---	0.15

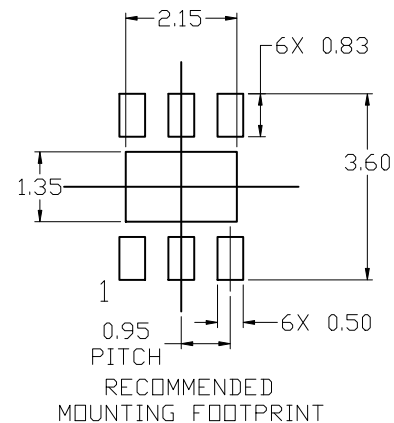

### GENERIC MARKING DIAGRAM\*

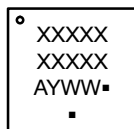

- XXXX = Specific Device Code
- A = Assembly Location
- Y = Year
- WW = Work Week
- = Pb-Free Package

(Note: Microdot may be in either location)

\* For additional information on our Pb-Free strategy and soldering details, please download the ON Semiconductor Soldering and Mounting Techniques Reference Manual, SOLDERM/D.

\*This information is generic. Please refer to device data sheet for actual part marking. Pb-Free indicator, "G" or microdot "▪", may or may not be present. Some products may not follow the Generic Marking.

<b>DOCUMENT NUMBER:</b>	<b>98AON21930D</b>	Electronic versions are uncontrolled except when accessed directly from the Document Repository. Printed versions are uncontrolled except when stamped "CONTROLLED COPY" in red.
<b>DESCRIPTION:</b>	<b>DFN6 3.0X3.3, 0.95P</b>	<b>PAGE 1 OF 1</b>

ON Semiconductor and ON are trademarks of Semiconductor Components Industries, LLC dba ON Semiconductor or its subsidiaries in the United States and/or other countries. ON Semiconductor reserves the right to make changes without further notice to any products herein. ON Semiconductor makes no warranty, representation or guarantee regarding the suitability of its products for any particular purpose, nor does ON Semiconductor assume any liability arising out of the application or use of any product or circuit, and specifically disclaims any and all liability, including without limitation special, consequential or incidental damages. ON Semiconductor does not convey any license under its patent rights nor the rights of others.

ON Semiconductor and  are trademarks of Semiconductor Components Industries, LLC dba ON Semiconductor or its subsidiaries in the United States and/or other countries. ON Semiconductor owns the rights to a number of patents, trademarks, copyrights, trade secrets, and other intellectual property. A listing of ON Semiconductor's product/patent coverage may be accessed at [www.onsemi.com/site/pdf/Patent-Marking.pdf](http://www.onsemi.com/site/pdf/Patent-Marking.pdf). ON Semiconductor reserves the right to make changes without further notice to any products herein. ON Semiconductor makes no warranty, representation or guarantee regarding the suitability of its products for any particular purpose, nor does ON Semiconductor assume any liability arising out of the application or use of any product or circuit, and specifically disclaims any and all liability, including without limitation special, consequential or incidental damages. Buyer is responsible for its products and applications using ON Semiconductor products, including compliance with all laws, regulations and safety requirements or standards, regardless of any support or applications information provided by ON Semiconductor. "Typical" parameters which may be provided in ON Semiconductor data sheets and/or specifications can and do vary in different applications and actual performance may vary over time. All operating parameters, including "Typicals" must be validated for each customer application by customer's technical experts. ON Semiconductor does not convey any license under its patent rights nor the rights of others. ON Semiconductor products are not designed, intended, or authorized for use as a critical component in life support systems or any FDA Class 3 medical devices or medical devices with a same or similar classification in a foreign jurisdiction or any devices intended for implantation in the human body. Should Buyer purchase or use ON Semiconductor products for any such unintended or unauthorized application, Buyer shall indemnify and hold ON Semiconductor and its officers, employees, subsidiaries, affiliates, and distributors harmless against all claims, costs, damages, and expenses, and reasonable attorney fees arising out of, directly or indirectly, any claim of personal injury or death associated with such unintended or unauthorized use, even if such claim alleges that ON Semiconductor was negligent regarding the design or manufacture of the part. ON Semiconductor is an Equal Opportunity/Affirmative Action Employer. This literature is subject to all applicable copyright laws and is not for resale in any manner.

## PUBLICATION ORDERING INFORMATION

### LITERATURE FULFILLMENT:

Email Requests to: [orderlit@onsemi.com](mailto:orderlit@onsemi.com)

ON Semiconductor Website: [www.onsemi.com](http://www.onsemi.com)

### TECHNICAL SUPPORT

North American Technical Support:  
Voice Mail: 1 800-282-9855 Toll Free USA/Canada  
Phone: 011 421 33 790 2910

### Europe, Middle East and Africa Technical Support:

Phone: 00421 33 790 2910

For additional information, please contact your local Sales Representative