

SMD CRYSTAL UNIT SPECIFICATIONS

Customer	帝哲
Customer P/N	
Product	2520 Seam Sealing Crystal
Nominal Frequency	27.120000MHz
HOSONIC P/N	E2SB27E0X000CE
Version	10C0
Issue Date	2021/8/11

HOSONIC		
Drawn	Checked	Approved
LUCY	ZOE	JOHN

Approved By Customer : _____



HOSONIC ELECTRONIC CO., LTD.



Revised Record

Rev.	Rev. Date	Item	Content	Remark
1.0	2021-08-11		Initial released	

I ELECTRICAL PARAMETERS

Electrical characteristics measured by S&A250B or equivalent.

No.	Item	Symb.	Electrical Specification				Remark	
			Min.	Typ.	Max.	Units		
1	Nominal Frequency	F0	27.120000			MHz		
2	Mode of Vibration		Fundamental					
3	Frequency Tolerance	$\Delta F/F0$	-10	-	10	ppm	At 25°C±3°C	
4	Operating Temperature Range	T _{OPR}	-30	-	85	°C		
5	Frequency Stability (over operating temperature)	TC	-10	-	10	ppm	Ref. to 25°C	
6	Storage Temperature	T _{STG}	-55	-	125	°C		
7	Load capacitance	CL	-	10	-	pF		
8	Equivalent Series Resistance	ESR	-	-	50	Ω		
9	Drive Level	DL	-	50	100	μW		
10	Insulation Resistance	IR	500	-	-	MΩ	At 100V _{DC}	
11	Shunt Capacitance	C0	-	-	3	pF		
12	Aging Per Year	Fa	-2	-	2	ppm	First Year	
13	Package type	E2SB						

NOTE: Storage Temperature is only for the product itself, the temperature for the packing material is -4~40°C.

I STORAGE REQUIRMENT

Storage environmental conditions: -4~40°C, 70%RH max.

Maximum storage time: 24 Months from date of manufacture.

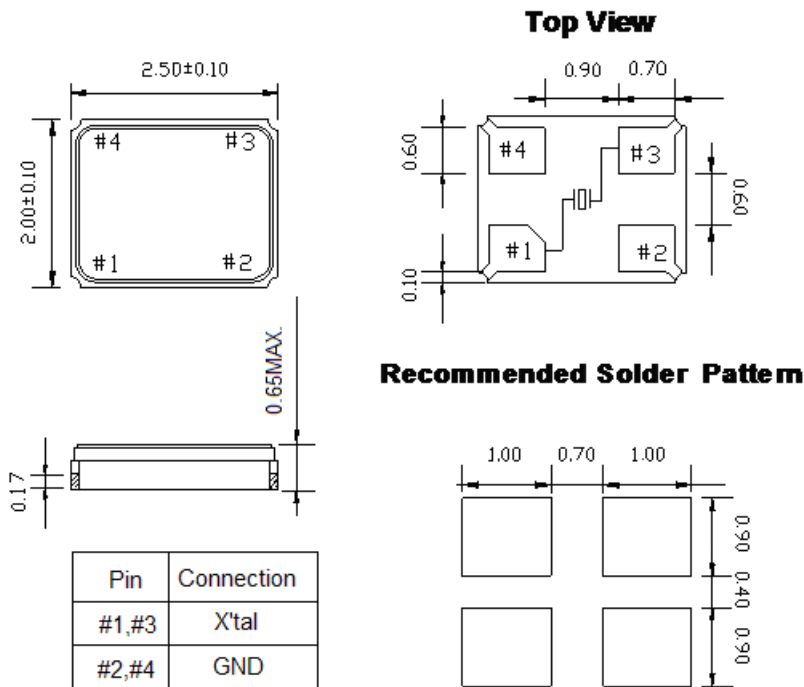
I OUTLINE DIMENSIONS (UNIT: mm)

*unlabeled tolerance: ± 0.1 mm

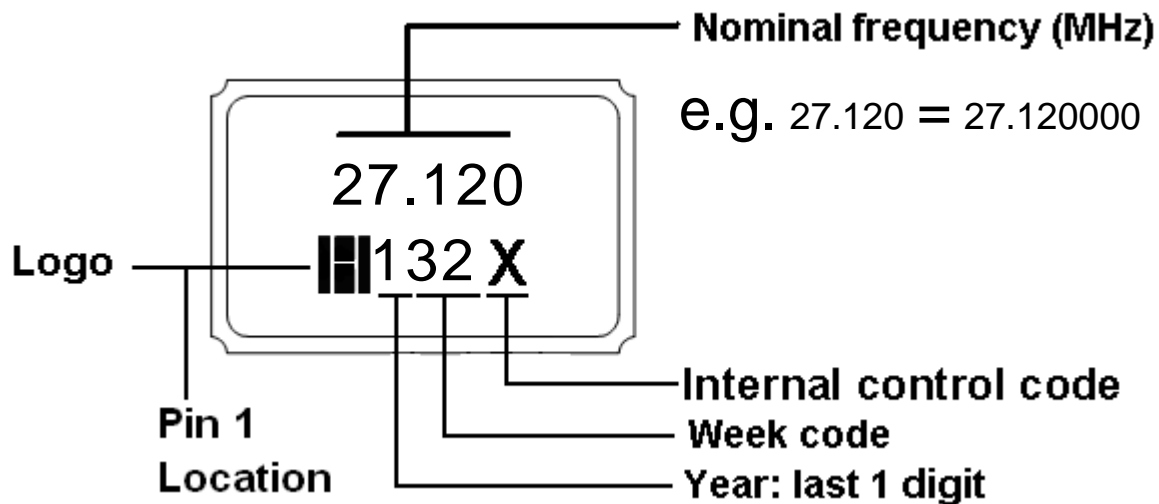
I MARKING:

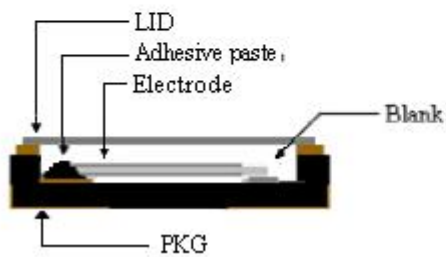
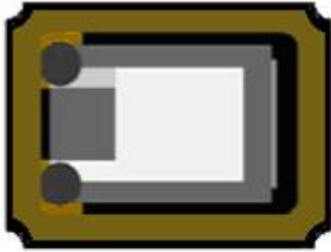
I PRODUCT LAYOUT

NO.	PART	MATERIAL	REMARK
1	LID	KOVAR(Fe+Co+Ni alloy)	
2	PKG	Al ₂ O ₃	Base
3	Blank	SiO ₂	Quartz
4	Adhesive paste	Ag/Silicon	Support
5	Electrode	Noble metal	

I REFLOW PROFILES

Profiles Feature	Pb-Free Assembly
Average Ramp-up Rate (Ts max to Tp)	3°C/second max.
Preheat <ul style="list-style-type: none"> ■ Temperature Min (Ts min) ■ Temperature Max (Ts max) ■ Time (ts min to ts max) 	125°C 200°C 60~180 seconds
Time maintained above <ul style="list-style-type: none"> ■ Temperature (T_L) ■ Time (t_L) 	217°C 60~150 seconds
Peak/Classification Temperature (Tp)	260°C
Time within 5°C of actual Peak Temperature (t _p)	20~40 seconds
Ramp-down rate	6°C/second max.
Time 25°C to Peak Temperature	8 minutes max.
Suggest reflow times	3 Times max

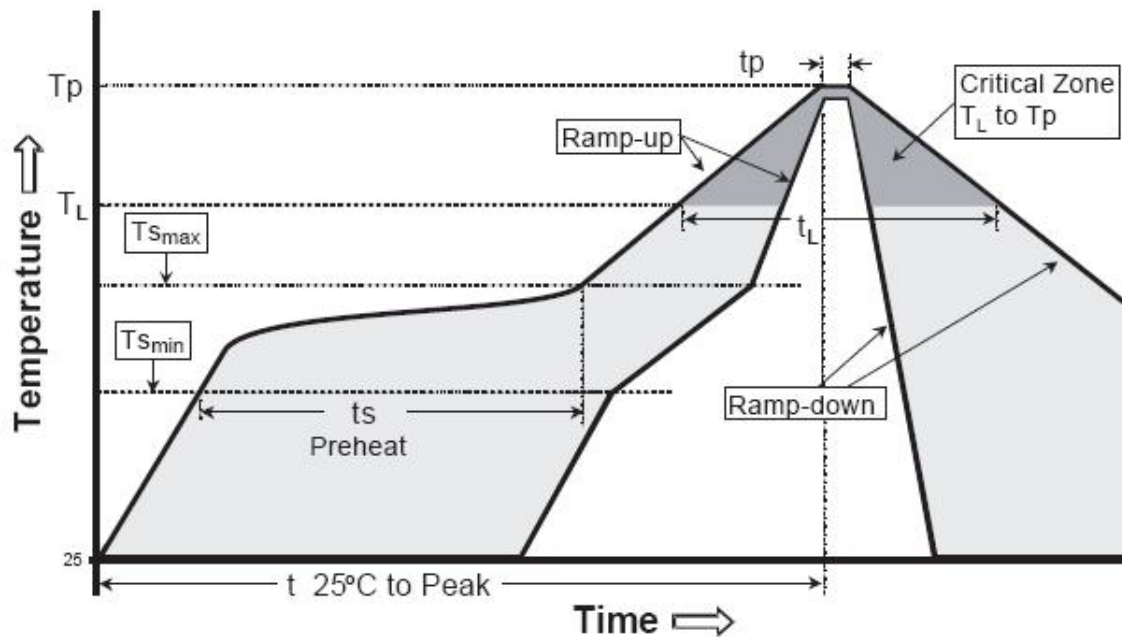

Remark: To reference JEDEC J-STD-020

I PACKAGE(reference to EIA-481)

Tape Dimensions(unit : mm)

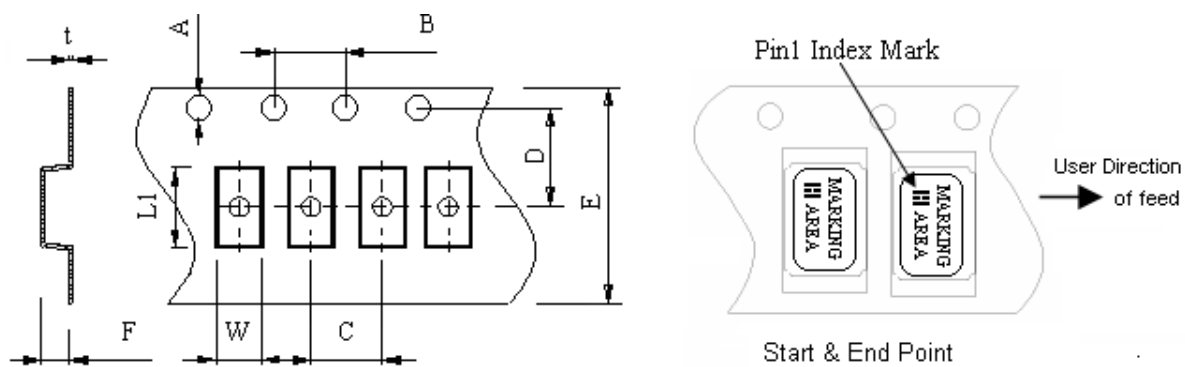

A	B	C	D	E	F	L1	W	t
1.50	4.0	4.0	3.5	8.0	1.0	2.75	2.25	0.2

Reel Dimensions(unit: mm)

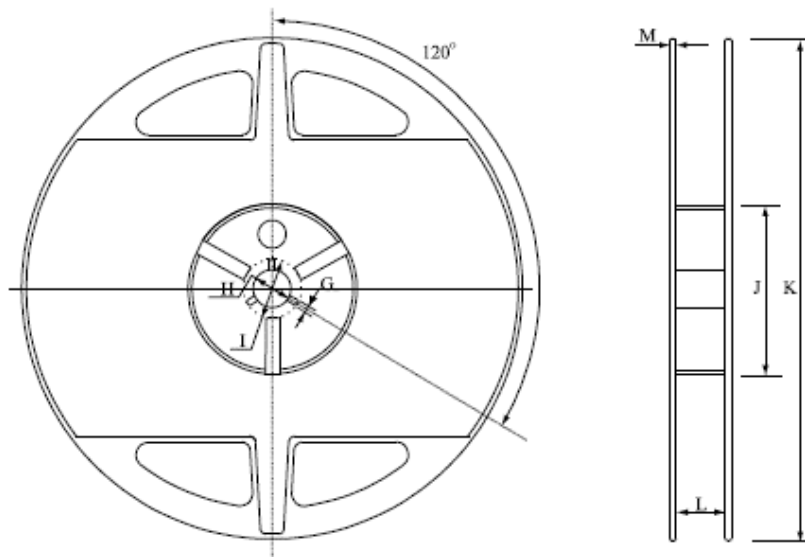

G	H	I	J	K	L	M
2.5	13.5	21.6	60.0	178	9.5	1.6

*3000pcs/Reel

Carton Dimension (unit : mm)



1 reel = 1 Inner box



20 Inner boxes = 1 Carton

60kpcs = 1 Carton

I RELIABILITY SPECIFICATIONS

No.	Test Item	Test Conditions	Reference
1	High Temperature Storage	Temperature: $125^{\circ}\text{C} \pm 3^{\circ}\text{C}$ Time: 1000 ± 12 Hours	MIL-STD-202 Method 108
2	Temperature Cycle	Temperature 1: $-55^{\circ}\text{C} \pm 3^{\circ}\text{C}$ Temperature 2: $125^{\circ}\text{C} \pm 3^{\circ}\text{C}$ Temperature change between T1 and T2 at soonest Run 1000 cycles, maintain T1 and T2 5minutes each in one cycle	JESD22 Method JA-104
3	Solder Heat Resistance	Pre-heat: 125°C 60~120 Seconds Solder Temperature: $260^{\circ}\text{C} \pm 5^{\circ}\text{C}$ Time: 30 Seconds	MIL-STD-202 Method 210
4	Drop Test	3 Times Free Fall from 150cm height to concrete floor.	IEC 68-2-32
5	High Temperature, High Humidity Storage	Temperature: $85^{\circ}\text{C} \pm 5^{\circ}\text{C}$ Relative Humidity: 80%--85% Time: 250Hours ± 12 Hours	MIL-STD-202 Method 103
6	Steam Aging	Temperature: $97^{\circ}\text{C} \pm 3^{\circ}\text{C}$ Time: 24 Hours 260°C solder pot to check solderability	J-STD-002
7	Solderability	Dip in flux 5~10 seconds Temperature: $245^{\circ}\text{C} \pm 5^{\circ}\text{C}$ Time: 10 Seconds	J-STD-002
8	Aging	Temperature: $85^{\circ}\text{C} \pm 2^{\circ}\text{C}$ Time: 250 ± 12 Hours	MIL-STD-202 Method 108
9	Thermal Shock	Temperature 1: $-55^{\circ}\text{C} \pm 3^{\circ}\text{C}$ Temperature 2: $125^{\circ}\text{C} \pm 3^{\circ}\text{C}$ Temperature change between T1 and T2: 5 seconds 100 cycles, maintain T1 and T2 for 30 minutes each in one cycle	MIL-STD-202 Method 107
10	Vibration	Frequency Range: 10Hz~2000Hz Amplitude: 1.5mm or 20G 4Hours in each direction, total 12Hours	MIL-STD-202 Method 204