

N-Channel High Density Trench MOSFET (60V, 0.5A)

PRODUCT SUMMARY		
V_{DS}	I_D	$R_{DS(on)}$ (Ω) Max
60V	0.5A	3 @ $V_{GS} = 10V, I_D=0.5A$
		4 @ $V_{GS} = 4.5V, I_D=0.5A$

Features

- Low On-Resistance
- Low Input Capacitance
- Fast Switching Speed
- Low Input/Output Leakage
- ESD Protected Up To 2KV
- Ordering information:GN2N7002K -G(Lead(Pb)-free and halogen-free)

RoHS+HF

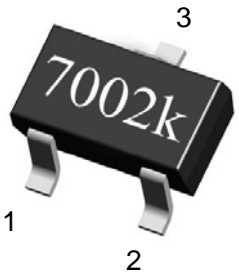

GN2N7002K Pin Assignment & Symbol

3-Lead Plastic **SOT-23**
Pin 1: Gate 2: Source 3: Drain

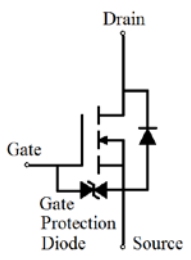

Absolute Maximum Ratings ($T_A=25^\circ\text{C}$, unless otherwise noted)

Symbol	Parameter	Ratings	Units
V_{DS}	Drain-Source Voltage	60	V
V_{GS}	Gate-Source Voltage	± 20	V
I_D	Drain Current	0.5	A
I_{DM}	Drain Current (Pulsed) ^a	0.8	A
P_D	Total Power Dissipation @ $T_A=25^\circ\text{C}$	0.35	W
T_j, T_{stg}	Operating Junction and Storage Temperature Range	-55 to +150	$^\circ\text{C}$
$R_{\theta JA}$	Thermal Resistance Junction to Ambient (PCB mounted) ^b	357	$^\circ\text{C/W}$

Electrical Characteristics (T_A=25°C, unless otherwise noted)

Symbol	Characteristic	Test Conditions	Min.	Typ.	Max.	Unit
• Off Characteristics						
BV _{DSS}	Drain-Source Breakdown Voltage	V _{GS} =0V, I _D =10μA	60	-	-	V
I _{DSS}	Zero Gate Voltage Drain Current	V _{DS} =48V, V _{GS} =0V	-	-	1	μA
I _{GSS}	Gate-Body Leakage Current	V _{GS} =±20V, V _{DS} =0V	-	-	±10	μA
• On Characteristics^c						
V _{GS(th)}	Gate Threshold Voltage	V _{DS} =10V, I _D =1mA	1	-	2.2	V
R _{DS(on)}	Drain-Source On-State Resistance	V _{GS} =10V, I _D =0.5A	-	1.9	3	Ω
		V _{GS} =4.5V, I _D =0.5A	-	2.4	4	
• Dynamic Characteristics^d						
C _{iss}	Input Capacitance	V _{DS} =25V, V _{GS} =0V, f=1MHz	-	21	50	pF
C _{oss}	Output Capacitance		-	11	25	
C _{rss}	Reverse Transfer Capacitance		-	4.2	5	
• Switching Characteristics^d						
Q _g	Total Gate Charge	V _{DS} =10V, I _D =0.3A, V _{GS} =4.5V	-	1.7	-	nC
t _{d(on)}	Turn-on Delay Time	V _{DD} =30V, I _D =0.2A, V _{GS} =10V, R _{GEN} =10Ω	-	10	-	nS
t _r	Turn-on Rise Time		-	50	-	
t _{d(off)}	Turn-Off Delay Time		-	17	-	
t _f	Turn-Off Fall Time		-	10	-	
• Diode Characteristics						
V _{SD}	Diode Forward Voltage ^c	V _{GS} =0 V, I _{SD} =0.5A	-	0.7	1.3	V
I _S	Diode Forward Current ^b		-	-	0.5	A

Notes:

- Repetitive Rating: Pulse width limited by maximum junction temperature.
- Surface Mounted on FR4 Board, t ≤ 10 sec.
- Pulse Test: Pulse Width ≤ 300μs, Duty Cycle ≤ 2%.
- Guaranteed by design, not subject to production

Characteristics Curve

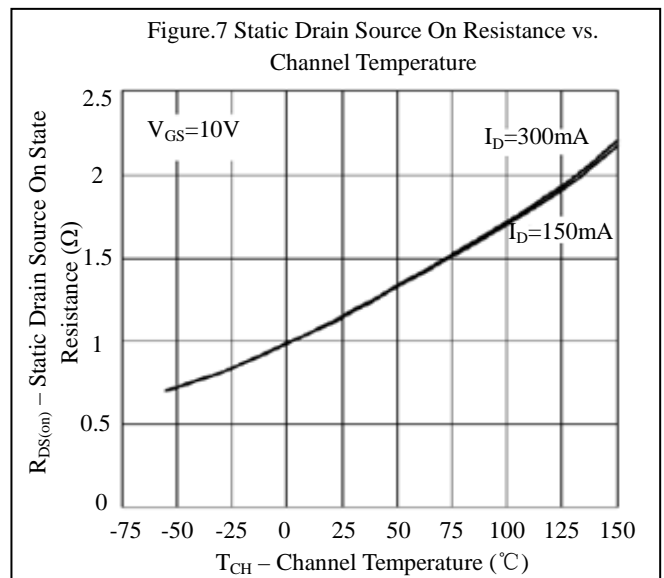
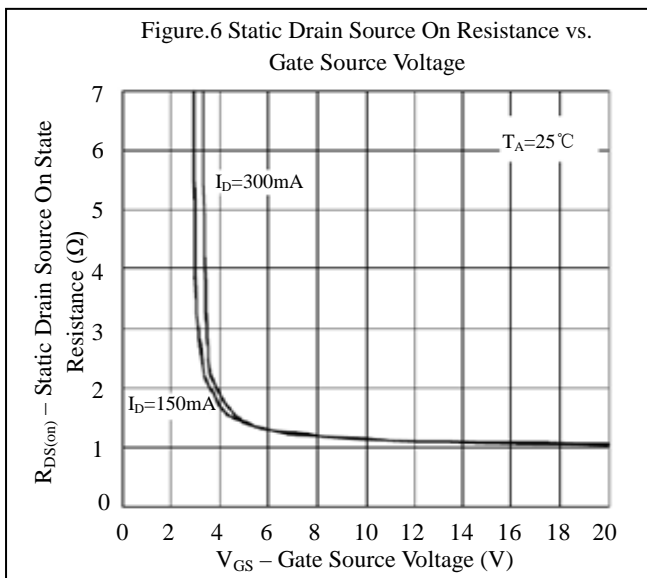
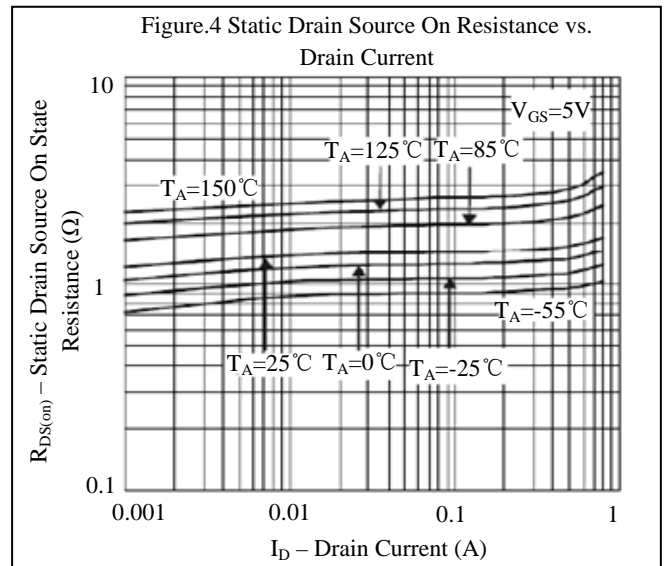
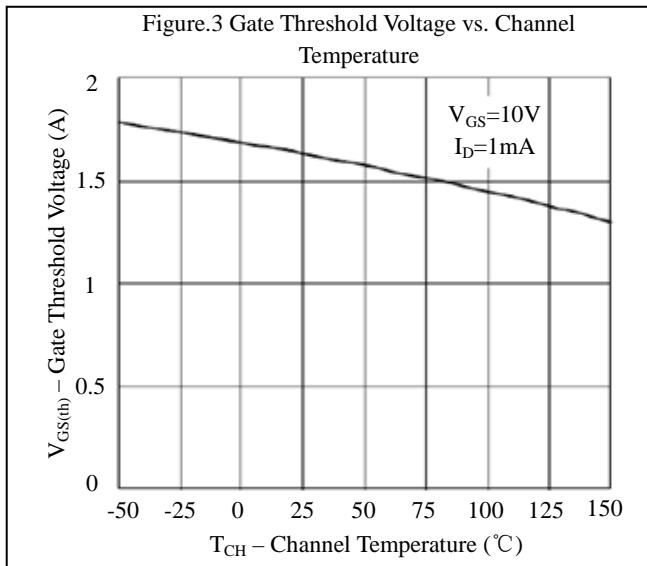
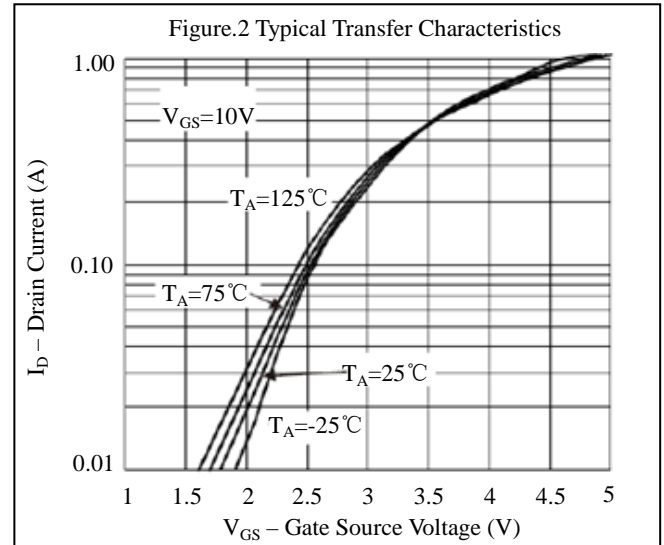
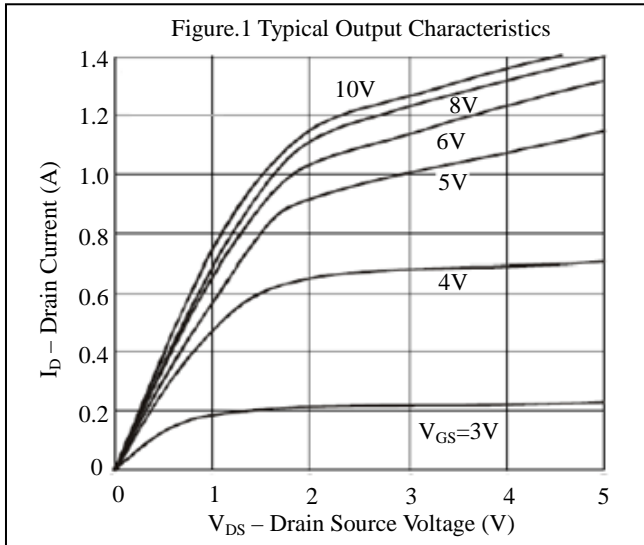

Characteristics Curve

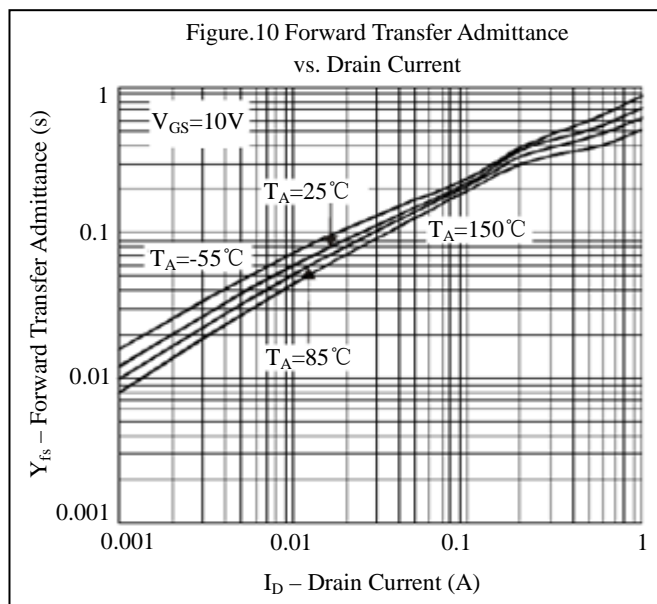
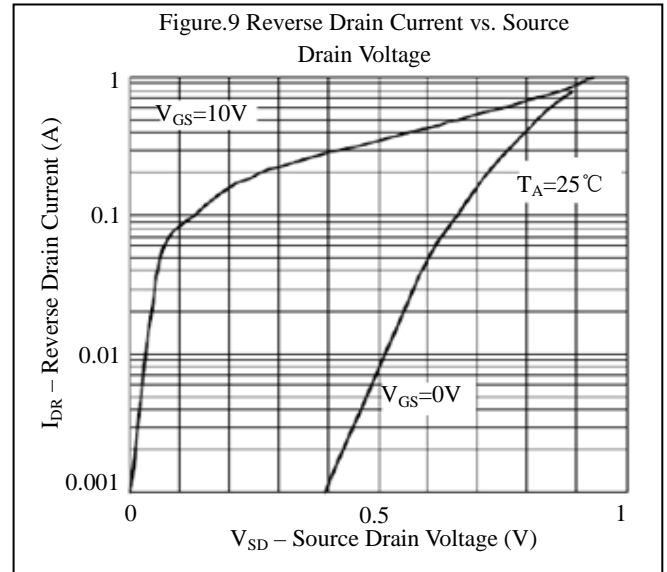
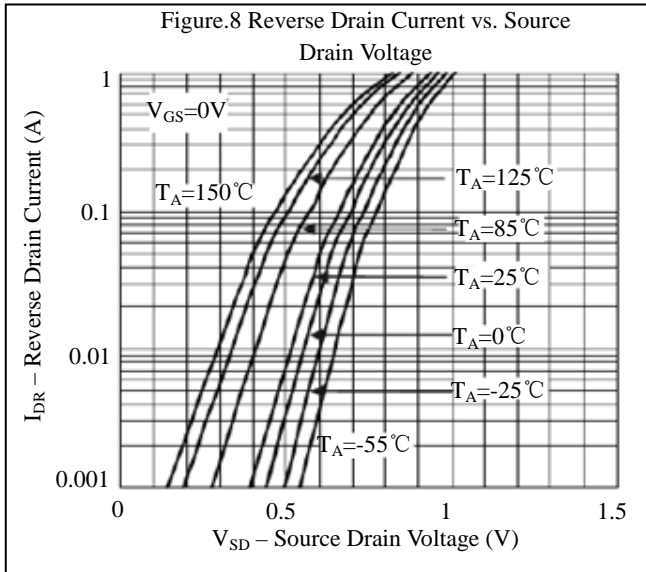

SOT-23 PACKAGE OUTLINE DIMENSIONS

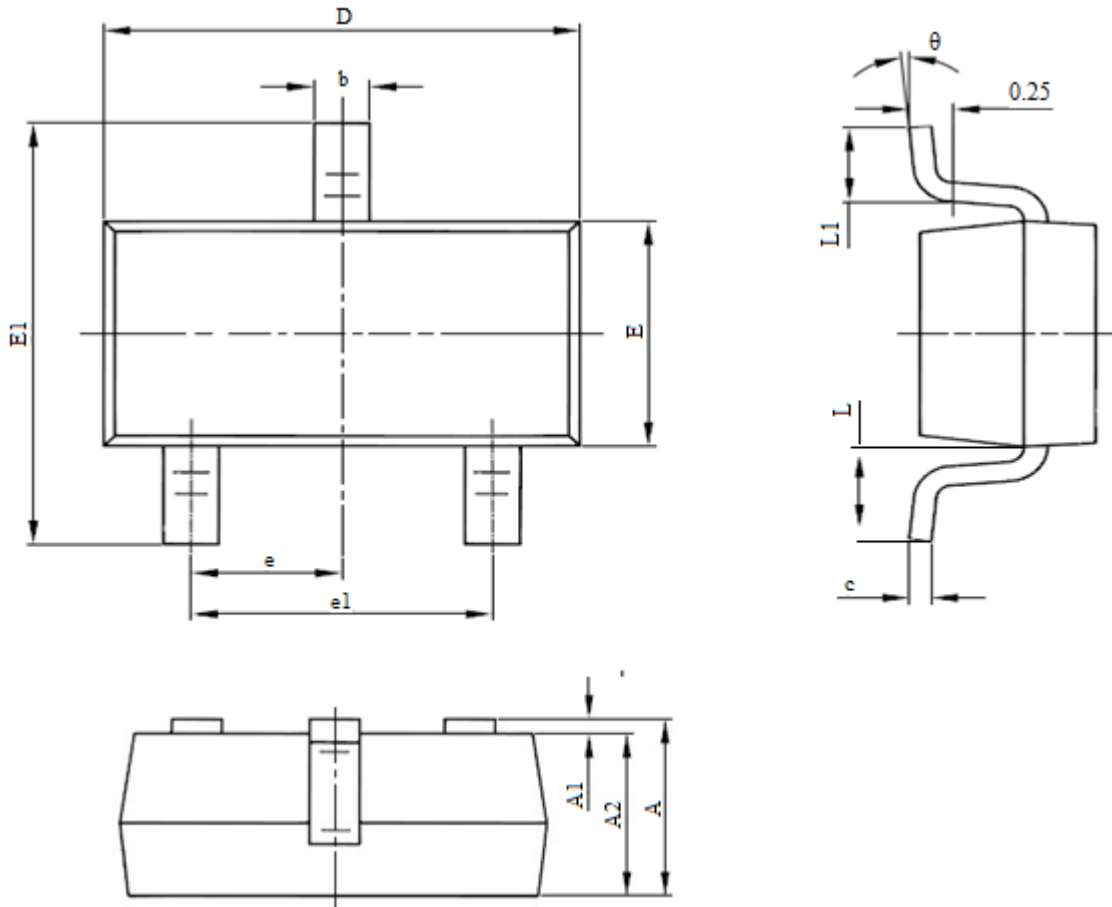

Symbol	Dimensions In Millimeters		Dimensions In Inches	
	Min	Max	Min	Max
A	0.9	1.15	0.035	0.045
A1	0	0.1	0	0.004
A2	0.9	1.05	0.035	0.041
b	0.3	0.5	0.012	0.020
c	0.08	0.15	0.003	0.006
D	2.8	3	0.11	0.118
E	1.2	1.4	0.047	0.055
E1	2.25	2.55	0.089	0.1
e	0.95(BSC)		0.037(BSC)	
e1	1.8	2	0.071	0.079
L	0.55REF		0.022REF	
L	0.3	0.5	0.012	0.02
θ	0°	8°	0°	8°



Notice

1. Specification of the products displayed herein is subject to change without notice. Continuous development may necessitate changes in technical data without notice. GEMMICRO or anyone on its behalf assumes no responsibility or liability for any errors or inaccuracies.
2. Stresses beyond those listed under “Absolute Maximum Ratings” may cause permanent damage to the device. These are stress ratings only and functional operation of the device at these or any other conditions beyond those indicated in the operational sections of the specifications are not implied. Exposure to absolute maximum rating conditions for extended periods may affect device reliability.