

TSC002*****

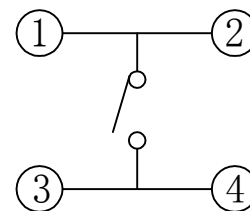

电路图

CIRCUIT DIAGRAM

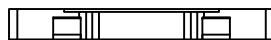
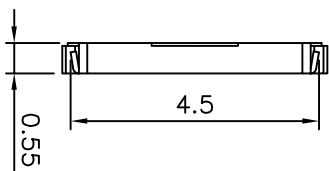
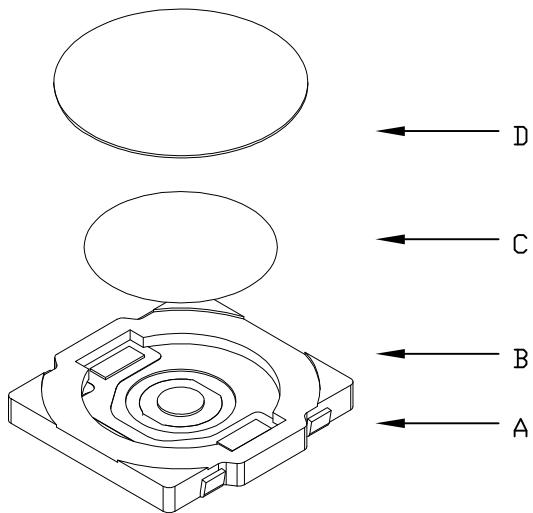
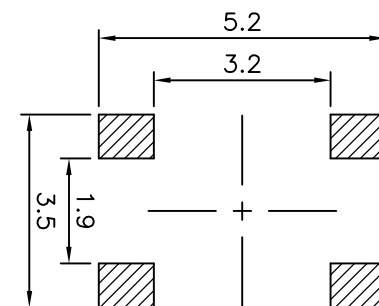
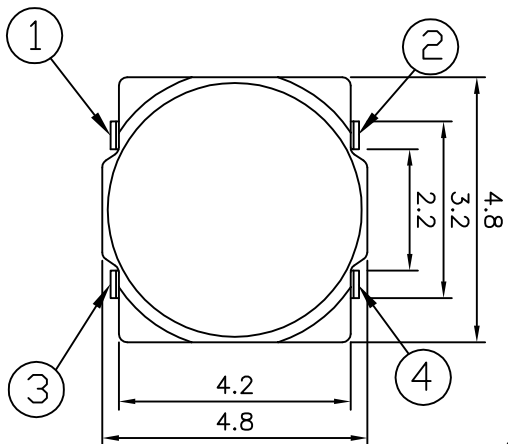

PCB. 焊接图

PCB. WELDING DRAWING

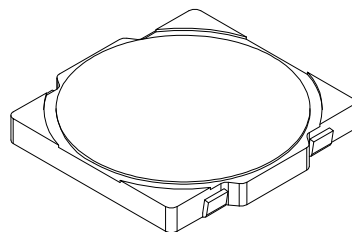

主要技术参数、性能

The Main Thchnology Performance

额定电流、电压 Rate voltage,current	50mA DC12V
接触电阻 Contact resistance	≤100mΩ
按力 Operating force	±50gf
行程 Travel	0.20±0.10mm
绝缘电阻 Insulated resistance	≥100MΩ
介电强度 Dielectric strength	≥250VAC/1min

T S C 0 0 2

寿命:
A: ≥30000次
B: ≥100000次
C: ≥200000次

高度H:
55: 0.55H

力度:
12: 120g
18: 180g
26: 260g

包装方式:
A: 散件
B: 冷封编带
C: 热封编带

D	防尘膜	聚酰亚胺	1	橙黄色
C	弹片	不锈钢	1	镀银
B	本体	LCP	1	白色
A	卡件	磷铜	1	镀银
项目 ITEM	名称 DESCRIPTION	材质 MATERIAL	数量 QTY	表面处理/颜色 FINISH/COLOR

					第一视角 FIRST VIEW		名称/NAME: 轻触开关 TACTILE SWITCH	
							型号/MODEL: TSC002*****	
标记 SING	处数 FREQUENCY	更改文件号 REVISION	签名 APPROVED	日期 DATE	比例 SCALE	1:1	一般公差 GENERAL TOLERANCE	
设计 DESIGN	朱元隆		2021. 06. 01		单位 UNIT	mm	≥0~2<	±0.10
审核 CHECKED	赵晓峰		2021. 06. 01		重量 WEIGHT		≥2~5<	±0.25
批准 APPROVED	陈乐峰		2021. 06. 01				≥5	±0.30
							角度 ANGLE	±0.5°

名称/NAME: 轻触开关 TACTILE SWITCH	
型号/MODEL: TSC002*****	
BZCN 浙江博众电气有限公司 ZHEJIANG BOZHONG ELECTRONIC CO., LTD.	