



南京时恒电子科技有限公司

规格承认书

APPROVAL SHEET

客户名称:

CUSTOMER _____

产品名称:

PART NAME _____

热敏电阻规格书

产品规格:

PART NUMBER _____

CMFA 103F3435

日期:

DATE _____

2021年8月17日

确 认

CONFIRM

客户

品保部: _____

制造部: _____

工程部: _____

供货商/制造商

规格书制作: 鞠晓丽 _____

业务员审核: _____

技术部审核: 程鹏 _____

品质部审核: 李少媛 _____

南京时恒电子科技有限公司

地址: 南京市江宁区湖熟镇金阳路18号 邮编: 211121

TEL: 025-52121868

FAX: 025-52122373



Http:// www.shiheng.com.cn

E-MAILsales@shiheng.com.cn

1 外形尺寸 Shape and Dimensions

- 尺寸: 见图 1 和表 1
- PCB 焊盘: 见图 2 和表 1
- Dimensions: See Fig.1 and Table 1.
- Recommended PCB pattern for reflow soldering: See Fig.2 and Table 1



图 1 Fig.1



图 2 Fig.2

表 1 (Table 1)

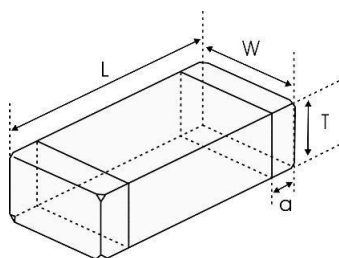
单位 unit: inch[mm]

类别Type	L	W	T	a	A	B	C
A [0603]	0.063±0.006 [1.6±0.15]	0.031±0.006 [0.8±0.15]	0.031±0.006 [0.8±0.15]	0.012±0.008 [0.3±0.2]	[0.6-0.8]	[0.6-0.7]	[0.6-0.8]

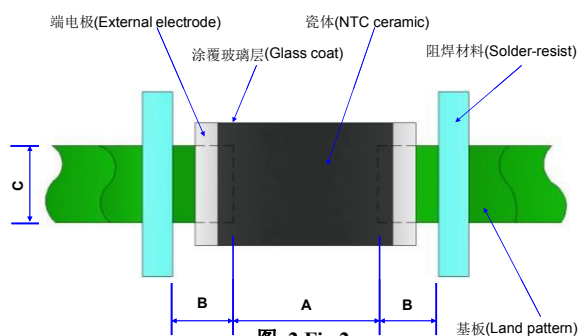
2 产品标识 (料号) Product Identification(Part Number)

CMF **A** **103** **F** **3435**

① ② ③ ④ ⑤

① 类别 Type	
CMF	片式NTC 热敏电阻器 Chip NTC Thermistor

② 外形尺寸(mm) External Dimensions (L×W×T)	
0201[A]	0.60×0.3 0×0.3 0
X[0402]	1.00×0.5 0×0.5 0
A[0603]	1.60×0.8 0×0.80
B[0805]	2.00×1.2 5×0.85

③ 25℃ 的零功率电阻Nominal Zero-Power Resistance	
472	4.7kΩ
103	10kΩ
④ 电阻值公差 Tolerance of Resistance	
F	±1%
G	±2%
H	±3%
J	±5%

⑤ B 值常数 B Constant	
3435	3435K
3950	3950K
4500	4500K

3 电气特性 Electrical Characteristics

型号 Part No	电阻值 Resistance (25℃) (kΩ)	B 常数B Constant (25/50℃) (K)	B 常数B Constant (25/85℃) (K)	允许工作电流 Permissible Operating Current (25℃) (mA)	耗散系数 Dissipation Factor (mW/℃)	热时间常数 Thermal Time Constant (s)	额定功率 Rated Electric Power(25℃) (mW)	工作温度 Operating ambient temperature (℃)
CMFA 103F3435	10±1%	3435±1%	3480	0.31	1.0	<5	100	-40~+125

4 检验和测试程序

测试条件

如无特别规定，检验和测试的标准大气环境条件如下：

- 环境温度：20±15℃；
- 相对湿度：65±20%；
- 气压：86 kPa~106 kPa

如果对测试结果有异议，则在下述条件下测试：

- 环境温度：25±2℃；
- 相对湿度：65±5%；
- 气压：86kPa ~ 106kPa

检查设备

外观检查：20 倍放大镜；

阻值检查：热敏电阻测试仪

4 Test and Measurement Procedures

Test Conditions

Unless otherwise specified, the standard atmospheric conditions for measurement/test as:

- Ambient Temperature: 20±15℃
- Relative Humidity: 65±20%
- Air Pressure: 86kPa to 106kPa

If any doubt on the results, measurements/tests should be made within the following limits:

- Ambient Temperature: 25±2℃
- Relative Humidity: 65±5%
- Air Pressure: 86kPa to 106kPa

Inspection Equipment

Visual Examination: 20× magnifier

Resistance value test: Thermistor resistance tester

5 电性测试 Electrical Test

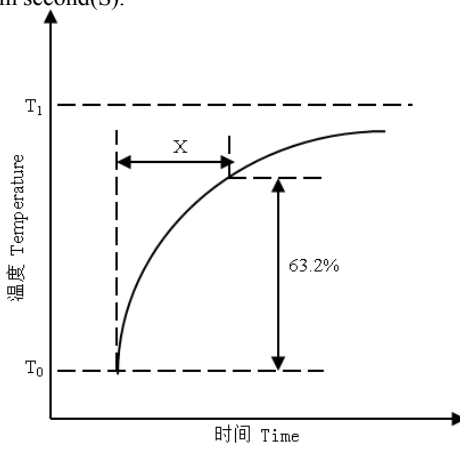
序号 No.	项目 Items	测试方法及备注 Test Methods and Remarks
1	25℃零功率电阻值 Nominal Zero-Power Resistance at 25℃(R25)	环境温度Ambient temperature: 25±0.05℃ 测试功率Measuring electric power: ≤0.1mW
2	B 值常数 Nominal B Constant	分别在环境温度 25±0.05℃, 50±0.05℃或 85±0.05℃下测量电阻值。 Measure the resistance at the ambient temperature of 25±0.05℃, 50±0.05℃ or 85±0.05℃. $B(25-50^{\circ}\text{C}) = \frac{\ln R_{25} - \ln R_{50}}{1/T_{25} - 1/T_{50}} \quad B(25-85^{\circ}\text{C}) = \frac{\ln R_{25} - \ln R_{85}}{1/T_{25} - 1/T_{85}}$ T: 绝对温度 (K) Absolute temperature (K)
3	热时间常数 Thermal Time Constant	<p>在零功率条件下，当热敏电阻的环境温度发生急剧变化时，热敏电阻元件产生最初温度 T₀ 与最终温度 T₁ 两者温度差的 63.2% 的温度变化所需要的时间，通常以秒(S)表示。</p> <p>The total time for the temperature of the thermistor to change by 63.2% of the difference from ambient temperature T₀ (°C) to T₁ (°C) by the drastic change of the power applied to thermistor from Non-zero Power to Zero-Power state, normally expressed in second(S).</p> 

4	耗散系数 Dissipation Factor	在一定环境温度下，NTC 热敏电阻通过自身发热使其温度升高 1℃时所需要的功率，通常以mW/℃表示。可由下面公式计算： The required power which makes the NTC thermistor body temperature raise 1℃ through self-heated, normally expressed in milliwatts per degree Celsius (mW/℃). It can be calculated by the following formula: $\delta = \frac{W}{T-T_0}$
5	额定功率 Rated Power	在环境温度 25℃下因自身发热使表面温度升高 100℃所需要的功率。The necessary electric power makes thermistor's temperature rise 100℃ by self-heating at ambient temperature 25℃.
6	允许工作电流 Permissible operating current	在静止空气中通过自身发热使其升温为 1℃的电流。 The current that keep body temperature of chip NTC on the PC board in still air rising 1℃by self-heating.

6 信赖性试验 Reliability Test

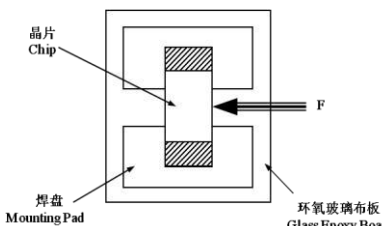
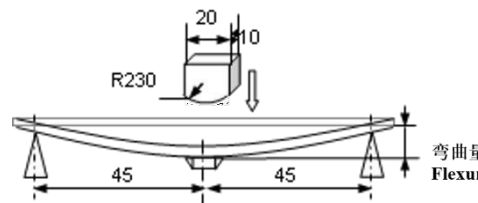
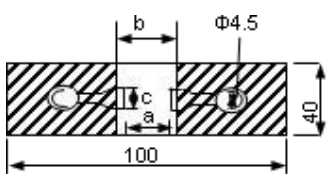
项目 Items	测试标准 Standard	测试方法及备注 Test Methods and Remarks	要求 Requirements																														
端头附着力 Terminal Strength	IEC 60068-2-21	<p>将晶片焊接在测试基板上（如右图所示的环氧玻璃布板），按箭头所示方向施加作用力； Solder the chip to the testing jig (glass epoxy board shown in the right) using eutectic solder. Then apply a force in the direction of the arrow.</p> <table border="1"> <thead> <tr> <th>尺寸 Size</th> <th>F</th> <th>保持时间 Duration</th> </tr> </thead> <tbody> <tr> <td>0201</td> <td>2N</td> <td rowspan="3">10±1s</td> </tr> <tr> <td>X, A</td> <td>5N</td> </tr> <tr> <td>B</td> <td>10N</td> </tr> </tbody> </table>	尺寸 Size	F	保持时间 Duration	0201	2N	10±1s	X, A	5N	B	10N	<p>端电极无脱落且瓷体无损伤。 No removal or split of the termination or other defects shall occur.</p> 																				
尺寸 Size	F	保持时间 Duration																															
0201	2N	10±1s																															
X, A	5N																																
B	10N																																
抗弯强度 Resistance to Flexure	IEC 60068-2-21	<p>将晶片焊接在测试基板上（如右图所示的环氧玻璃布板），按下图箭头所示方向施加作用力； Solder the chip to the test jig (glass epoxy board shown in the right) using a eutectic solder. Then apply a force in the direction shown as follow;</p>  <table border="1"> <thead> <tr> <th>尺寸 Size</th> <th>弯曲变形量 Flexure</th> <th>施压速度 Pressurizing Speed</th> <th>保持时间 Duration</th> </tr> </thead> <tbody> <tr> <td>0201,</td> <td>1mm</td> <td rowspan="2"><0.5mm/s</td> <td rowspan="2">10±1s</td> </tr> <tr> <td>X, A, B</td> <td>2mm</td> </tr> </tbody> </table>	尺寸 Size	弯曲变形量 Flexure	施压速度 Pressurizing Speed	保持时间 Duration	0201,	1mm	<0.5mm/s	10±1s	X, A, B	2mm	<p>① 无外观损伤。 No visible damage. ② $\Delta R_{25}/R_{25} \leq 2\%$</p> <p>单位 unit: mm</p> <table border="1"> <thead> <tr> <th>类型 Type</th> <th>a</th> <th>b</th> <th>c</th> </tr> </thead> <tbody> <tr> <td>0201</td> <td>0.25</td> <td>0.3</td> <td>0.3</td> </tr> <tr> <td>X</td> <td>0.4</td> <td>1.5</td> <td>0.5</td> </tr> <tr> <td>A</td> <td>1.0</td> <td>3.0</td> <td>1.2</td> </tr> <tr> <td>B</td> <td>1.2</td> <td>4.0</td> <td>1.65</td> </tr> </tbody> </table> 	类型 Type	a	b	c	0201	0.25	0.3	0.3	X	0.4	1.5	0.5	A	1.0	3.0	1.2	B	1.2	4.0	1.65
尺寸 Size	弯曲变形量 Flexure	施压速度 Pressurizing Speed	保持时间 Duration																														
0201,	1mm	<0.5mm/s	10±1s																														
X, A, B	2mm																																
类型 Type	a	b	c																														
0201	0.25	0.3	0.3																														
X	0.4	1.5	0.5																														
A	1.0	3.0	1.2																														
B	1.2	4.0	1.65																														

振动 Vibration	IEC 60068-2-80	① 将晶片焊接在测试基板上（如右图所示的环氧玻璃布板）； Solder the chip to the testing jig (glass epoxy board shown in the left) using eutectic solder. ② 晶片以全振幅为 1.5mm 进行振动，频率范围为 10Hz ~55 Hz； The chip shall be subjected to a simple harmonic motion having total amplitude of 1.5mm, the frequency being varied uniformly between the approximate limits of 10 and 55 Hz. ③ 振动频率按 10Hz→55Hz→10Hz 循环，周期为 1 分钟，在空间三个互相垂直的方向上各振动 2 小时（共 6 小时）。 The frequency ranges from 10 to 55 Hz and return to 10 Hz shall be traversed in approximately 1 minute. This motion shall be applied for a period of 2 hours in each 3 mutually perpendicular directions (total of 6 hours).	无外观损伤。 No visible damage. 															
坠落 Dropping	IEC 60068-2-32	从 1m 的高度让晶片自由坠落至水泥地面 10 次。 Drop a chip 10 times on a concrete floor from a height of 1 meter.	无外观损伤。 No visible damage.															
可焊性 Solderability	IEC 60068-2-58	① 焊接温度 Solder temperature: 245±5 °C. ② 浸渍时间 Duration: 3±0.3s. ③ 焊锡成分 Solder: 96.5Sn/3.0Ag/0.5Cu. ④ 助焊剂 Flux: (重量比) 25%松香和 75%酒精 25% Resin and 75% ethanol in weight.	① 无外观损伤； No visible damage. ② 元件端电极的焊锡覆盖率不小于 95%。 Wetting shall exceed 95% coverage.															
耐焊性 Resistance to Soldering Heat	IEC 60068-2-58	① 焊接温度 Solder temperature: 260±5 °C. ② 浸渍时间 Duration: 10±1s. ③ 焊锡成分 Solder: 96.5Sn/3.0Ag/0.5Cu. ④ 助焊剂 Flux: (重量比) 25%松香和 75%酒精 25% Resin and 75% ethanol in weight. ⑤ 试验后标准条件下放置 1~2 小时后测量。 The chip shall be stabilized at normal condition for 1~2 hours before measuring.	① 无外观损伤； No visible damage. ② $ \Delta R_{25}/R_{25} \leq 2\%$ ③ $ \Delta B/B \leq 1\%$															
温度周期 Temperature cycling	IEC 60068-2-14	① 无负载于下表所示的环境条件下重复 5 次。 5 cycles of following sequence without loading. <table border="1" data-bbox="491 1429 1040 1621"> <thead> <tr> <th>步骤 Step</th> <th>温度 Temperature</th> <th>时间 Time</th> </tr> </thead> <tbody> <tr> <td>1</td> <td>-40±5 °C</td> <td>30±3min</td> </tr> <tr> <td>2</td> <td>25±2 °C</td> <td>5±3min</td> </tr> <tr> <td>3</td> <td>125±2 °C</td> <td>30±3min</td> </tr> <tr> <td>4</td> <td>25±2 °C</td> <td>5±3min</td> </tr> </tbody> </table> ② 试验后标准条件下放置 1~2 小时后测量。 The chip shall be stabilized at normal condition for 1~2 hours before measuring.	步骤 Step	温度 Temperature	时间 Time	1	-40±5 °C	30±3min	2	25±2 °C	5±3min	3	125±2 °C	30±3min	4	25±2 °C	5±3min	① 无外观损伤； No visible damage. ② $ \Delta R_{25}/R_{25} \leq 2\%$ ③ $ \Delta B/B \leq 1\%$
步骤 Step	温度 Temperature	时间 Time																
1	-40±5 °C	30±3min																
2	25±2 °C	5±3min																
3	125±2 °C	30±3min																
4	25±2 °C	5±3min																
高温存放 Resistance to dry heat	IEC 60068-2-2	① 在 125±5 °C 空气中，无负载放置 1000±24 小时。 125±5 °C in air, for 1000±24 hours without loading. ② 试验后标准条件下放置 1~2 小时后测量。 The chip shall be stabilized at normal condition for 1~2 hours before measuring.	① 无外观损伤； No visible damage. ② $ \Delta R_{25}/R_{25} \leq 2\%$ ③ $ \Delta B/B \leq 1\%$															

低温存放 Resistance to cold	IEC 60068-2-1	① 在 $-40\pm 3^{\circ}\text{C}$ 空气中, 无负载放置 1000 ± 24 小时。 $-40\pm 3^{\circ}\text{C}$ in air, for 1000 ± 24 hours without loading. ② 试验后标准条件下放置 1~2 小时后测量。 The chip shall be stabilized at normal condition for 1~2 hours before measuring.	① 无外观损伤; No visible damage. ② $ \Delta R25/R25 \leq 2\%$ ③ $ \Delta B/B \leq 1\%$
湿热存放 Resistance to damp heat	IEC 60068-2-78	① 在 $40\pm 2^{\circ}\text{C}$, 相对湿度 90~95%空气中, 无负载放置 1000 ± 24 小时。 $40\pm 2^{\circ}\text{C}$, 90~95%RH in air, for 1000 ± 24 hours without loading. ② 试验后标准条件下放置 1~2 小时后测量。 The chip shall be stabilized at normal condition for 1~2 hours before measuring.	① 无外观损伤; No visible damage. ② $ \Delta R25/R25 \leq 2\%$ ③ $ \Delta B/B \leq 1\%$
高温负荷 Resistance to high temperature load	IEC 60539-1 5.25.4	① 在 $85\pm 2^{\circ}\text{C}$ 空气中, 施加允许工作电流 1000 ± 48 小时。 $85\pm 2^{\circ}\text{C}$ in air with permissive operating current for 1000 ± 48 hours ② 试验后标准条件下放置 1~2 小时后测量。 The chip shall be stabilized at normal condition for 1~2 hours before measuring.	① 无外观损伤; No visible damage. ② $ \Delta R25/R25 \leq 2\%$ ③ $ \Delta B/B \leq 1\%$

7 编带 Taping

类型 Type	0201	X	A	B
编带厚度 Tape thickness(mm)	0.5 ± 0.15	0.5 ± 0.15	0.8 ± 0.15	0.85 ± 0.2
编带材质 Tape material	纸带 Paper Tape			
每盘数量 Quantity per Reel	15K	10K	4K	4K

(1) 编带图 Taping Drawings

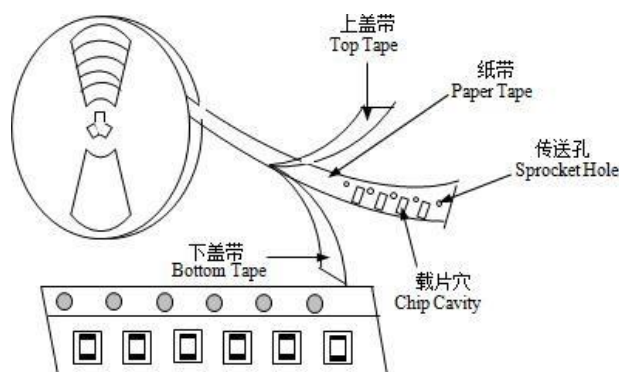

(2) 纸带尺寸 Paper Tape Dimensions (单位 Unit: mm)

CMF0201 系列 CMF0201 series

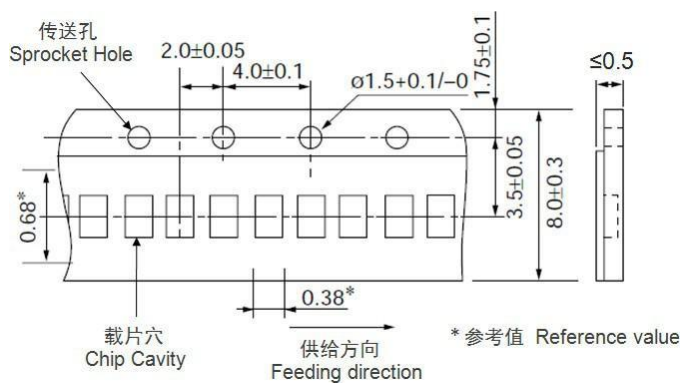

CMFX 系列 CMFX series

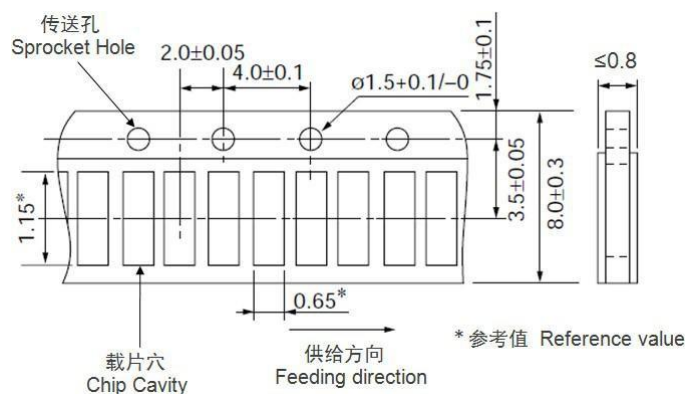

CMFA 系列 CMFA series

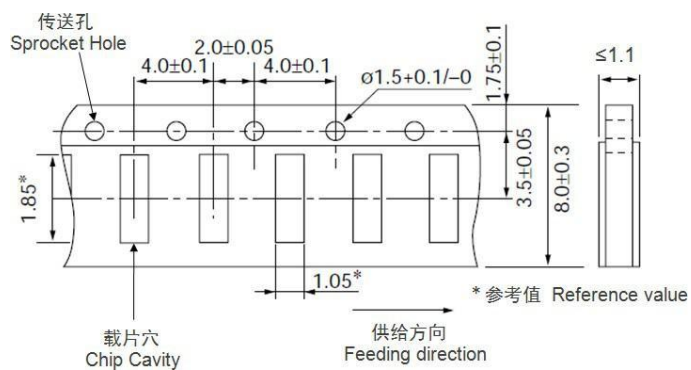

CMFB 系列 CMFB series

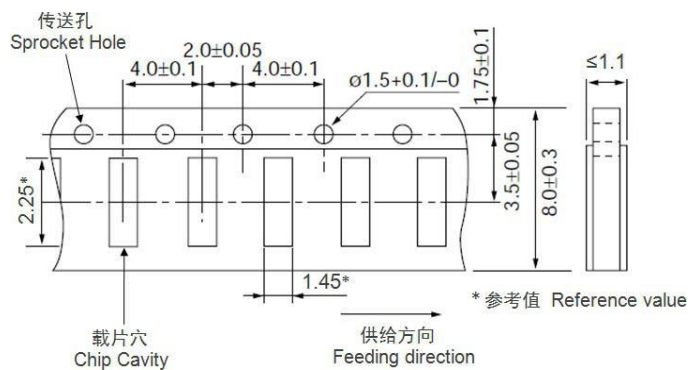

(3) 卷盘尺寸 Reel Dimensions (单位 Unit: mm)

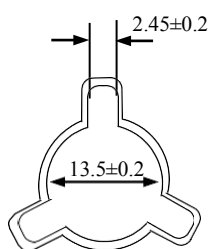
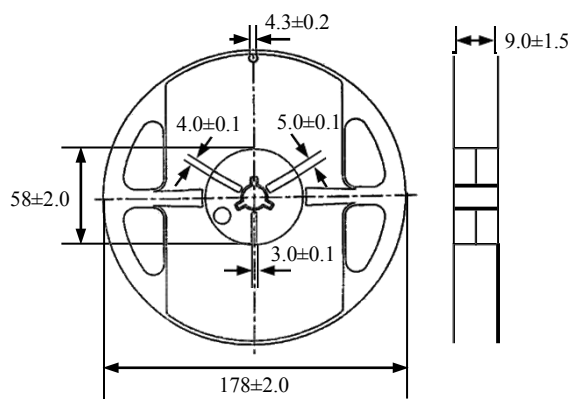

8 储存

• 储存条件

- a. 储存温度: $-10^{\circ}\text{C} \sim 40^{\circ}\text{C}$
- b. 相对湿度: $\leq 75\% \text{RH}$
- c. 避免接触粉尘、腐蚀性气氛和阳光

• 储存期限: 产品交付后 6 个月

9 注意事项

• CMF 系列热敏电阻不可在以下条件下工作或储存:

- (1) 腐蚀性气体或还原性气体
(氯气、硫化氢气体、氨气、硫酸气体、一氧化氮等)。
- (2) 挥发性或易燃性气体
- (3) 多尘条件
- (4) 高压或低压条件
- (5) 潮湿场所
- (6) 存在盐水、油、化学液体或有机溶剂的场所
- (7) 强烈振动
- (8) 存在类似有害条件的其他场所

• CMF 系列热敏电阻的陶瓷属于易碎材料, 使用时不可施加过大压力或冲击。

• CMF 系列热敏电阻不可在超过目录规定的温度范围情况下工作。

8 Storage

• Storage Conditions

- a. Storage Temperature: $-10^{\circ}\text{C} \sim 40^{\circ}\text{C}$
- b. Relative Humidity: $\leq 75\% \text{RH}$
- c. Keep away from corrosive atmosphere and sunlight.

• Period of Storage: 6 Months after delivery

9 Notes & Warnings

• The CMF series thermistors shall not be operated and stored under the following environmental condition:

- (1) Corrosive or deoxidized atmospheres
(such as chlorine, sulfurated hydrogen, ammonia, sulfuric acid, nitric oxide and so on)
- (2) Volatile or inflammable atmospheres
- (3) Dusty condition
- (4) Excessively high or low pressure condition
- (5) Humid site
- (6) Places with brine, oil, chemical liquid or organic solvent
- (7) Intense vibration
- (8) Places with analogously deleterious conditions

• The ceramic body of the CMF series thermistors is fragile, no excessive pressure or impact shall be exerted on it.

• The CMF series thermistors shall not be operated beyond the specified "Operating Temperature Range" in the catalog.

10 建议焊接条件

• 回流焊

温升 1~2°C/sec.

预热: 150~170°C/90±30 sec.

大于 240°C时间: 20~40sec

峰值温度: 最高 260°C/10 sec.

焊锡: 96.5Sn/3.0Ag/0.5Cu

回流焊: 最多 2 次

10 Recommended Soldering Technologies

• Re-flowing Profile

1~2°C/sec. Ramp

Pre-heating: 150~170°C/90±30 sec.

Time above 240°C: 20~40 sec.

Peak temperature: 260°C Max./10 sec.

Solder paste: 96.5Sn/3.0Ag/0.5Cu

Max.2 times for re-flowing

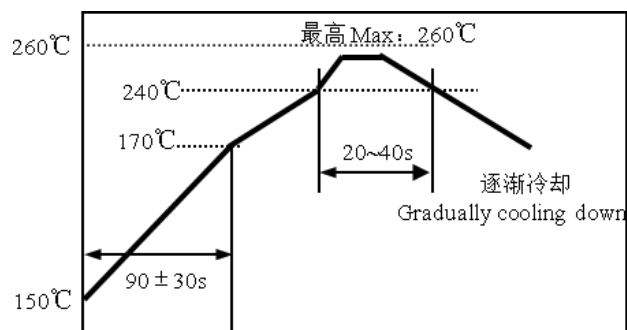

• 手工焊

烙铁功率: 最大 20W

预热: 150°C/60sec.

烙铁头温度: 最高 280°C

焊接时间: 最多 3sec.

焊锡: 96.5Sn/3.0Ag/0.5Cu

手工焊: 最多 1 次

• Iron Soldering Profile

Iron soldering power: Max.20W

Pre-heating: 150°C/60sec.

Soldering Tip temperature: 280°C Max.

Soldering time: 3 sec Max.

Solder paste: 96.5Sn/3.0Ag/0.5Cu

Max.1 times for iron soldering

[注: 不要使烙铁头接触到端头]

[Note: Take care not to apply the tip of the soldering iron to the terminal electrodes.]

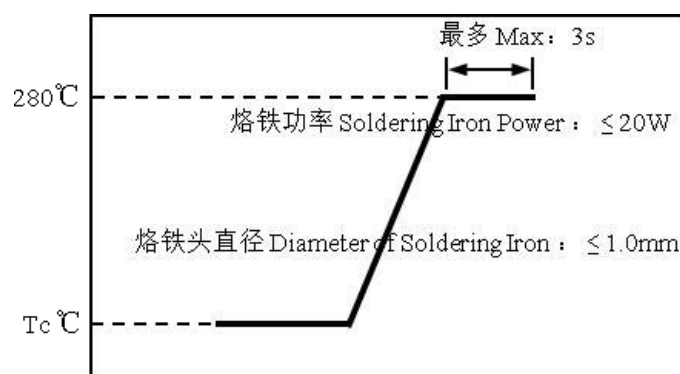

11 R-T 表 R-T table

CMFA 103F3435

温度 Temp. (°C)	R 最小值 R_Min (Kohm)	R 中心值 R_Cent (Kohm)	R 最大值 R_Max (Kohm)	阻值公差 Res TOL.	温度公差 Temp. TOL.(°C)
-40	192.371	200.225	208.380	4.07%	0.69
-39	182.189	189.524	197.134	4.02%	0.69
-38	172.599	179.449	186.553	3.96%	0.68
-37	163.561	169.961	176.593	3.90%	0.68
-36	155.043	161.022	167.216	3.85%	0.67
-35	147.012	152.600	158.384	3.79%	0.67
-34	139.439	144.661	150.064	3.73%	0.66
-33	132.294	137.176	142.224	3.68%	0.66
-32	125.552	130.117	134.833	3.63%	0.65
-31	119.189	123.457	127.865	3.57%	0.65
-30	113.181	117.173	121.293	3.52%	0.64
-29	107.507	111.241	115.093	3.46%	0.64
-28	102.147	105.640	109.242	3.41%	0.63
-27	97.083	100.351	103.719	3.36%	0.62
-26	92.295	95.354	98.504	3.30%	0.62
-25	87.769	90.632	93.578	3.25%	0.61
-24	83.489	86.168	88.925	3.20%	0.61
-23	79.440	81.948	84.527	3.15%	0.60
-22	75.608	77.956	80.370	3.10%	0.60
-21	71.981	74.180	76.439	3.04%	0.59
-20	68.548	70.607	72.721	2.99%	0.59
-19	65.296	67.225	69.203	2.94%	0.58
-18	62.216	64.022	65.874	2.89%	0.57
-17	59.297	60.989	62.723	2.84%	0.57
-16	56.531	58.116	59.739	2.79%	0.56
-15	53.908	55.393	56.913	2.74%	0.56
-14	51.421	52.812	54.236	2.69%	0.55
-13	49.062	50.366	51.698	2.65%	0.54
-12	46.824	48.045	49.293	2.60%	0.54
-11	44.700	45.844	47.013	2.55%	0.53
-10	42.683	43.755	44.850	2.50%	0.52
-9	40.768	41.772	42.798	2.45%	0.52
-8	38.949	39.890	40.851	2.41%	0.51
-7	37.221	38.103	39.002	2.36%	0.50
-6	35.578	36.405	37.247	2.31%	0.50
-5	34.017	34.792	35.581	2.27%	0.49
-4	32.533	33.259	33.998	2.22%	0.48
-3	31.121	31.802	32.493	2.18%	0.48
-2	29.779	30.416	31.064	2.13%	0.47
-1	28.501	29.098	29.704	2.08%	0.46
0	27.285	27.844	28.412	2.04%	0.46
1	26.127	26.651	27.182	1.99%	0.45

温度 Temp. (°C)	R 最小值 R_Min (Kohm)	R 中心值 R_Cent (Kohm)	R 最大值 R_Max (Kohm)	阻值公差 Res TOL.	温度公差 Temp. TOL.(°C)
2	25.024	25.515	26.013	1.95%	0.44
3	23.974	24.434	24.899	1.91%	0.43
4	22.974	23.404	23.840	1.86%	0.43
5	22.020	22.423	22.831	1.82%	0.42
6	21.111	21.488	21.870	1.78%	0.41
7	20.245	20.598	20.955	1.73%	0.41
8	19.419	19.749	20.082	1.69%	0.40
9	18.630	18.939	19.251	1.65%	0.39
10	17.878	18.167	18.459	1.60%	0.38
11	17.161	17.431	17.703	1.56%	0.38
12	16.476	16.728	16.982	1.52%	0.37
13	15.821	16.057	16.295	1.48%	0.36
14	15.197	15.417	15.639	1.44%	0.35
15	14.600	14.806	15.012	1.40%	0.34
16	14.030	14.222	14.414	1.36%	0.34
17	13.485	13.664	13.844	1.32%	0.33
18	12.964	13.131	13.298	1.28%	0.32
19	12.466	12.621	12.777	1.24%	0.31
20	11.990	12.134	12.280	1.20%	0.30
21	11.534	11.669	11.804	1.16%	0.30
22	11.099	11.224	11.349	1.12%	0.29
23	10.681	10.798	10.914	1.08%	0.28
24	10.282	10.390	10.498	1.04%	0.27
25	9.900	10.000	10.100	1.00%	0.26
26	9.527	9.627	9.727	1.04%	0.27
27	9.169	9.269	9.369	1.08%	0.29
28	8.828	8.927	9.026	1.11%	0.30
29	8.500	8.599	8.698	1.15%	0.31
30	8.186	8.285	8.383	1.19%	0.32
31	7.886	7.984	8.082	1.23%	0.33
32	7.598	7.695	7.792	1.26%	0.35
33	7.322	7.419	7.515	1.30%	0.36
34	7.058	7.153	7.249	1.34%	0.37
35	6.805	6.899	6.994	1.38%	0.38
36	6.562	6.655	6.749	1.41%	0.40
37	6.328	6.421	6.514	1.45%	0.41
38	6.105	6.196	6.288	1.48%	0.42
39	5.890	5.980	6.071	1.52%	0.43
40	5.684	5.773	5.863	1.56%	0.45
41	5.487	5.575	5.663	1.59%	0.46
42	5.297	5.384	5.471	1.63%	0.47
43	5.115	5.200	5.287	1.66%	0.49
44	4.940	5.024	5.109	1.70%	0.50
45	4.771	4.855	4.939	1.73%	0.51

温度 Temp. (°C)	R 最小值 R_Min (Kohm)	R 中心值 R_Cent (Kohm)	R 最大值 R_Max (Kohm)	阻值公差 Res TOL.	温度公差 Temp. TOL.(°C)
46	4.610	4.692	4.775	1.77%	0.52
47	4.455	4.535	4.617	1.80%	0.54
48	4.305	4.385	4.465	1.84%	0.55
49	4.162	4.240	4.319	1.87%	0.57
50	4.024	4.101	4.179	1.90%	0.58
51	3.891	3.967	4.044	1.94%	0.59
52	3.763	3.838	3.914	1.97%	0.61
53	3.641	3.714	3.788	2.01%	0.62
54	3.522	3.595	3.668	2.04%	0.63
55	3.409	3.480	3.552	2.07%	0.65
56	3.299	3.369	3.440	2.10%	0.66
57	3.194	3.262	3.332	2.14%	0.68
58	3.092	3.160	3.228	2.17%	0.69
59	2.994	3.061	3.128	2.20%	0.70
60	2.900	2.965	3.031	2.24%	0.72
61	2.809	2.873	2.938	2.27%	0.73
62	2.722	2.785	2.849	2.30%	0.75
63	2.637	2.699	2.762	2.33%	0.76
64	2.556	2.617	2.679	2.36%	0.78
65	2.478	2.537	2.598	2.39%	0.79
66	2.402	2.461	2.520	2.43%	0.81
67	2.329	2.387	2.445	2.46%	0.82
68	2.259	2.315	2.373	2.49%	0.84
69	2.191	2.246	2.303	2.52%	0.85
70	2.125	2.180	2.236	2.55%	0.87
71	2.062	2.116	2.170	2.58%	0.88
72	2.001	2.054	2.107	2.61%	0.90
73	1.942	1.994	2.047	2.64%	0.91
74	1.885	1.936	1.988	2.67%	0.93
75	1.830	1.880	1.931	2.70%	0.94
76	1.777	1.826	1.876	2.73%	0.96
77	1.726	1.774	1.823	2.76%	0.98
78	1.677	1.724	1.772	2.79%	0.99
79	1.629	1.675	1.722	2.82%	1.01
80	1.582	1.628	1.674	2.85%	1.02
81	1.538	1.582	1.628	2.88%	1.04
82	1.494	1.538	1.583	2.91%	1.05
83	1.452	1.495	1.539	2.94%	1.07
84	1.412	1.454	1.497	2.97%	1.09
85	1.373	1.414	1.456	3.00%	1.10
86	1.335	1.375	1.417	3.02%	1.12
87	1.298	1.338	1.379	3.05%	1.14
88	1.263	1.302	1.342	3.08%	1.15
89	1.229	1.267	1.306	3.11%	1.17

温度 Temp. (°C)	R 最小值 R_Min (Kohm)	R 中心值 R_Cent (Kohm)	R 最大值 R_Max (Kohm)	阻值公差 Res TOL.	温度公差 Temp. TOL.(°C)
90	1.195	1.233	1.272	3.14%	1.19
91	1.163	1.200	1.238	3.16%	1.20
92	1.132	1.168	1.206	3.19%	1.22
93	1.102	1.137	1.174	3.22%	1.24
94	1.073	1.108	1.143	3.25%	1.25
95	1.044	1.079	1.114	3.27%	1.27
96	1.017	1.051	1.085	3.30%	1.29
97	0.990	1.023	1.057	3.33%	1.31
98	0.965	0.997	1.030	3.36%	1.32
99	0.940	0.971	1.004	3.38%	1.34
100	0.915	0.947	0.979	3.41%	1.36
101	0.892	0.923	0.954	3.44%	1.38
102	0.869	0.899	0.930	3.46%	1.39
103	0.847	0.877	0.907	3.49%	1.41
104	0.826	0.855	0.885	3.51%	1.43
105	0.805	0.833	0.863	3.54%	1.45
106	0.785	0.813	0.842	3.57%	1.46
107	0.765	0.793	0.821	3.59%	1.48
108	0.746	0.773	0.801	3.62%	1.50
109	0.728	0.754	0.782	3.64%	1.52
110	0.710	0.736	0.763	3.67%	1.54
111	0.693	0.718	0.745	3.70%	1.55
112	0.676	0.701	0.727	3.72%	1.57
113	0.659	0.684	0.710	3.75%	1.59
114	0.643	0.668	0.693	3.77%	1.61
115	0.628	0.652	0.677	3.80%	1.63
116	0.613	0.637	0.661	3.82%	1.65
117	0.598	0.622	0.645	3.85%	1.67
118	0.584	0.607	0.630	3.87%	1.69
119	0.571	0.593	0.616	3.89%	1.70
120	0.557	0.579	0.602	3.92%	1.72
121	0.544	0.566	0.588	3.94%	1.74
122	0.532	0.553	0.575	3.97%	1.76
123	0.519	0.540	0.562	3.99%	1.78
124	0.507	0.528	0.549	4.02%	1.80
125	0.496	0.516	0.537	4.04%	1.82