

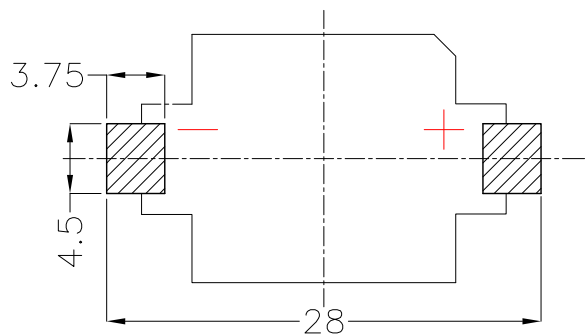

REV.	ECN NO.	REVISED	DATE

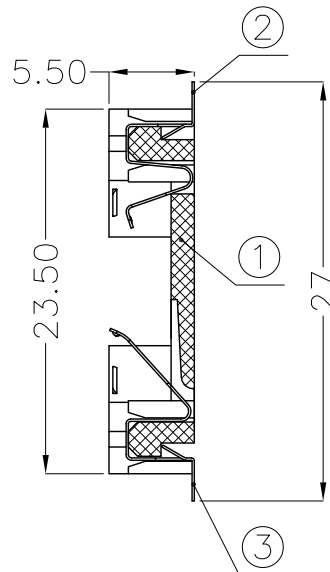
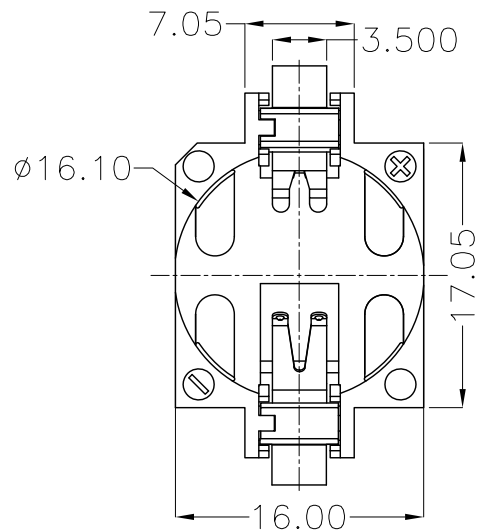

PCB Layout Diagram  
Top View

NOTE:  
 1.MATERIAL:  
 a.HOUSING:LCP UL94V-0  
 b.CONTACT:PHOSPHOR BRONZE  
 (SURFACE PLATING: Au 1U")  
 SEE ORDERING INFORMATION  
 2.ELECTRIC:  
 a.CONTACT RESISTANCE: 30 MILLIOHMS MAX  
 b.INSULATION RESISTANCE: 1000 MEGA OHMS MIN  
 c.DIELECTNIC VOLTAGE: 500V AC ONE SEC LEVEL  
 d.OPERATING TEMPERATURE: -25°C~ +85°C

ORDERING INFORMATION

BS-16-B\*\*\*006

电池座系列  
 BS-16系列  
 SMT 180° TYPE

PLATING:  
 A-Au1U"  
 J-Ni100U"~120U"  
 K-Sn100U"~120U"

MATERIAL:  
 1A-PBT BLACK  
 1B-PA66 BLACK  
 2A-PPA BROWN  
 2B-PPA BLACK  
 3A-PPS BROWN  
 3B-PPS BLACK  
 4A-LCP WHITE  
 4B-LCP BLACK

工程部  
 2020-05-11  
 LQ HUANG

3	TERMINAL(-)	1	PHOSPHOR BRONZE, T=0.15mm	Au-Plating
2	TERMINAL(+)	1	PHOSPHOR BRONZE, T=0.15mm	Au-Plating
1	HOUSING	1	LCP	WHITE
NO.	PART NAME	Q'TY	MATERIAL	PLATING & COLOR

UNLESS OTHERWISE SPECIFIED TOLERANCES		MYOUNG 美阳 www.meiyangdz.com			
DECIMALS: X :±0.30 X.X :±0.25 X.XX :±0.20 X.XXX :±0.10	ANGLES: X :±1° X.X :±0.5°	DSND	YangFeng	DATE	2020-05-11
WEIGHT: 1.34g		CHKD	ZhouRuicai	DATE	2020-05-11
SHEET 1 OF 1		APVD	XueShunyong	DATE	2020-05-11
SCALE: 2:1		SIZE: A4	VIEW:	TITLE: BS-1632-1 Au SMT	
UNIT: mm		REV.: A/0	OBJECT: MY	PART NO.: BS-16-B4AA006	
				DRAW NO.:MY-CP-0224	

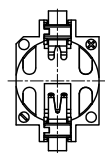

产品

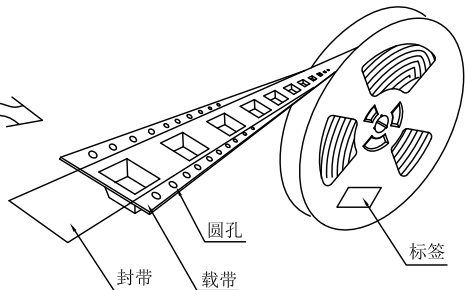

圆孔

封带

载带

标签

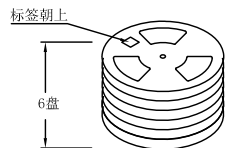

标签朝上

6盘

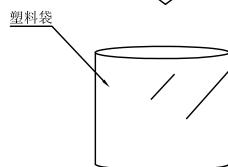

塑料袋

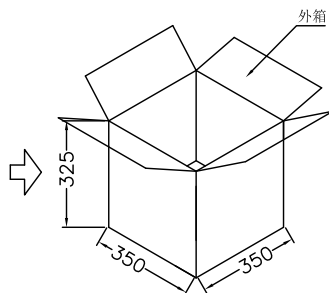

外箱

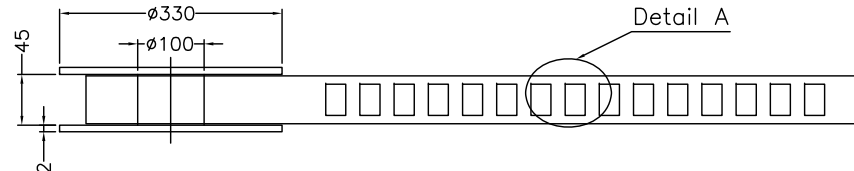
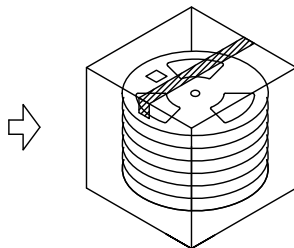

Detail A

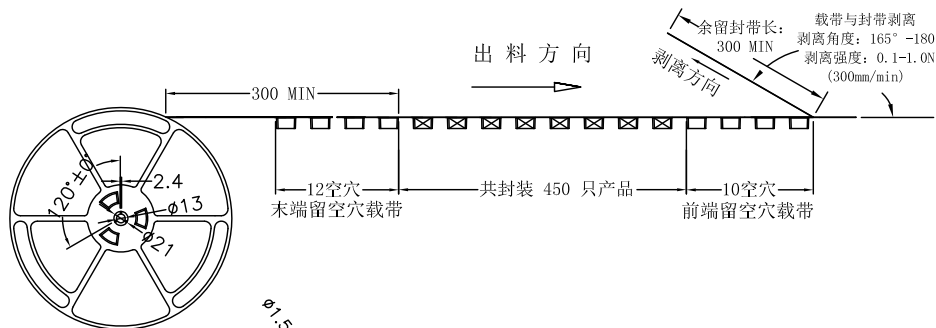

出料方向

剥离方向

余留封带长: 300 MIN  
载带与封带剥离角度: 165° -180°  
剥离强度: 0.1-1.0N (300mm/min)

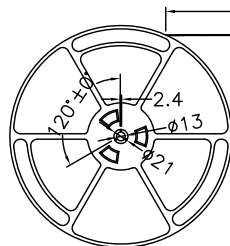

φ1.50±0.10  
φ0.00

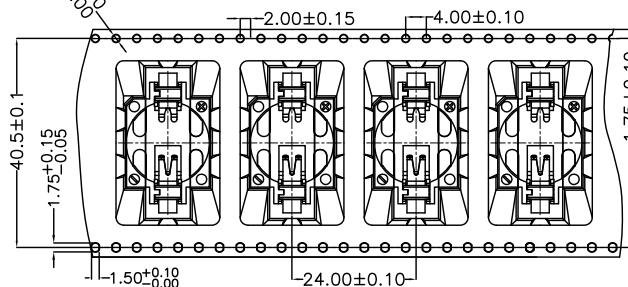

Detail A

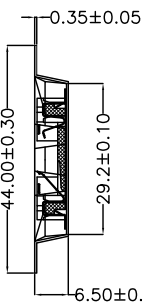

技术要求:

1. 圆孔十个孔距离累计允许公差为±0.2mm
2. 带长250mm内容许弯曲度1mm
3. 材料厚度以在载带边缘测量为准
4. 所有尺寸定义依循EIA-481-C系准则定义之
5. 材料: 黑色PS T=0.35mm
6. 所有卷轮为灰蓝挖空旋转塑胶卷轮
7. 整模成型长度: 11.328M,
8. 非指明公差范围为: ±0.1mm; 超过250mm不计算累计误差
9. 型腔外形凡未标明处倒角R为0.2-0.3; 拔模斜度未标注的为3° 以下

包装信息:

- 1、每卷盘装产品 450 只, 卷盘外侧贴相关标签;
- 2、每 6 卷盘放在一个塑料袋中;
- 3、每外箱装6盘, 产品总数: 2700 只;
- 4、外箱上下用胶纸封成“工”字;
- 5、净重: 3.42 KG, 毛重: 5.6 KG。



UNLESS OTHERWISE SPECIFIED TOLERANCES		<b>MYOUNG 美阳</b> www.meiyangdz.com			
DECIMALS: X : ±*** X.X : ±*** X.XX : ±*** X.XXX : ±***	ANGLES: X : ±*** X.X : ±***	DSND	YangFeng	DATE	2017-12-01
		CHKD	ZhouRuicai	DATE	2017-12-01
		APVD	XueShunyong	DATE	2017-12-01
WEIGHT:		SCALE:	3:1	SIZE:	A4
SHEET 1 OF 1		UNIT:	mm	REV.:	A/0
		VIEW:	④ ⊞	OBJECT:	MY
		TITLE:		BS-1632-1 SMT 卷装	
		PART NO.:		BS-16-B***00*-R	
		DRAW NO.:		MY-BD-0012	