

Overview

KEMET L-SWS ferrite-based Wire Wound Chip Inductors are designed for signal line EMI suppression. The bottom-surface electrode structure allows for high Q and narrow inductance tolerance. This small size wire wound inductor is suitable for module design of signal line applications.

Applications

- PC, tablet, peripherals
- Portable equipment
- Optical storage, HDD
- Digital still camera
- Gaming
- Network equipment

Benefits

- High Q
- Narrow inductance tolerance $\pm 5\%$
- Bottom surface electrode
- Inductance value from 0.12 to 100 μH
- Rated current range from 0.08 – 0.61 A
- Rated DC Resistance Range Typical 0.13 – 8 Ω
- Operating temperature range from -40°C to $+105^{\circ}\text{C}$
- Low profile 1.8 mm maximum

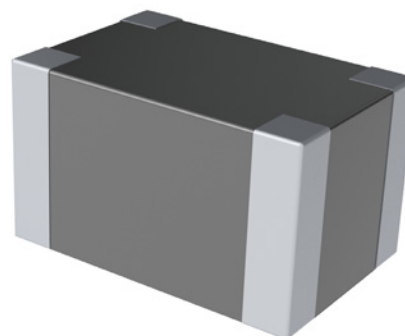

Part Number System

L	0806	B	1R5	J	SWS	T
Inductor	EIA Case Size (L" x W")	Specification	Inductance Value (μH)	Inductance Tolerance	Series	Packaging
	0806 (2016 in mm)	B = Bottom Surface Electrode	R = decimal point Examples: 1R5 = 1.5 μH The first two digits represent the inductance value. The third digit indicates the number of zeros to be added. Examples: 100 = 10 μH 101 = 100 μH	J = $\pm 5\%$	SWS = Signal line wire wound chip type	T = Tape & Reel

Dimensions – Millimeters (Inches)

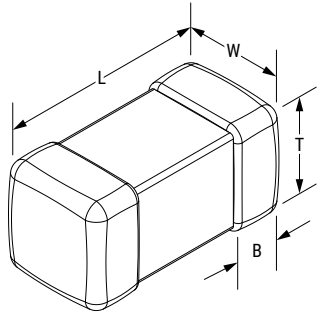
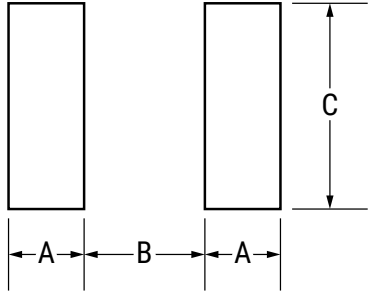
Dimensions - Millimeters (Inches)						Land Pattern - Millimeters		
								
EIA Size Code	Metric Size Code	L Length	W Width	T Thickness	B Bandwidth	A	B	C
0806	2016	2.00 (0.079) ±0.20 (0.008)	1.60 (0.063) ±0.20 (0.008)	1.60 (0.063) ±0.20 (0.008)	0.50 (0.020) ±0.2 (0.008)	0.6	1.0	1.8

Performance Characteristics

Item	Performance Characteristics
Operating Temperature Range	-40°C to +105°C
Rated Inductance Range	0.12 – 100 µH
Inductance Tolerance	±5%
Rated Current Range	0.08 – 0.61 A
Rated DC Resistance Range Typical	0.13 – 8 Ω
Rated DC Resistance Range Maximum	0.169 – 10.4 Ω

Environmental Compliance

All KEMET Chip Inductors are RoHS and REACH Compliant.

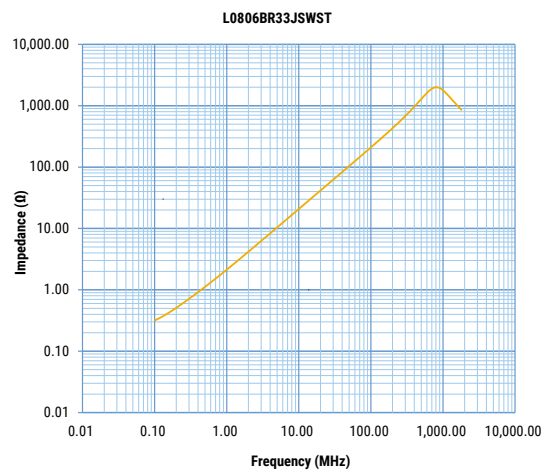
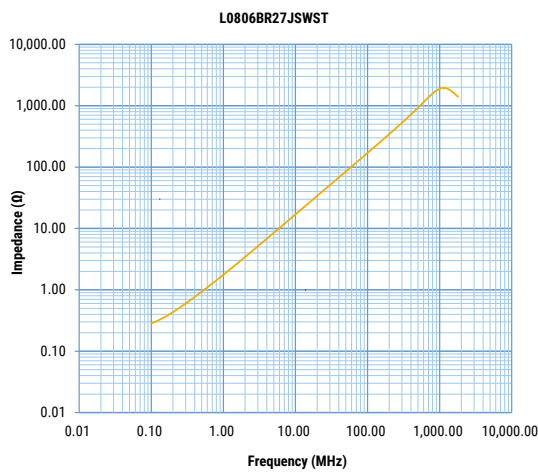
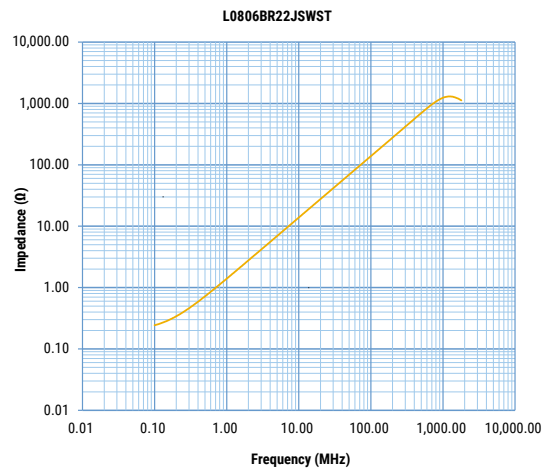
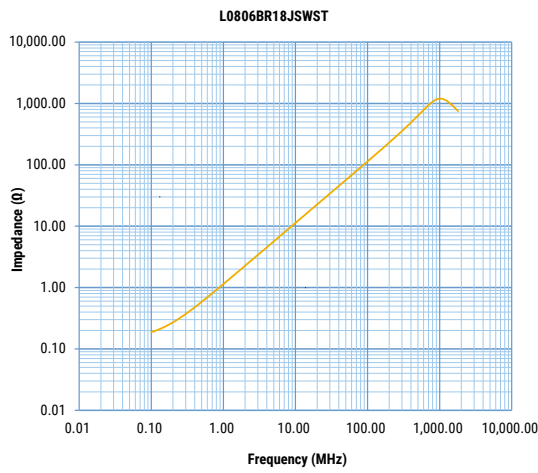
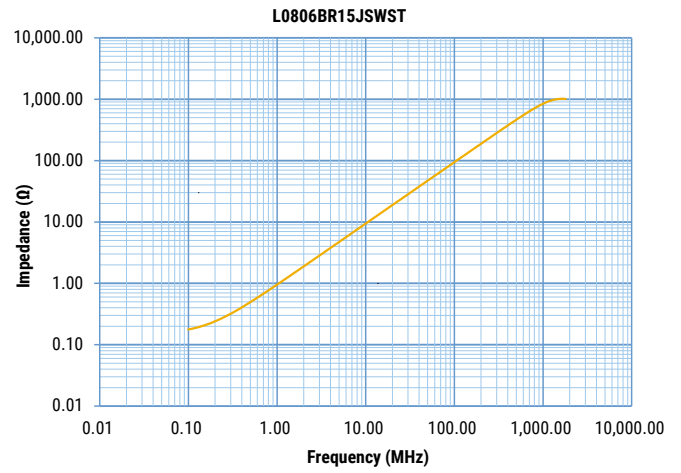
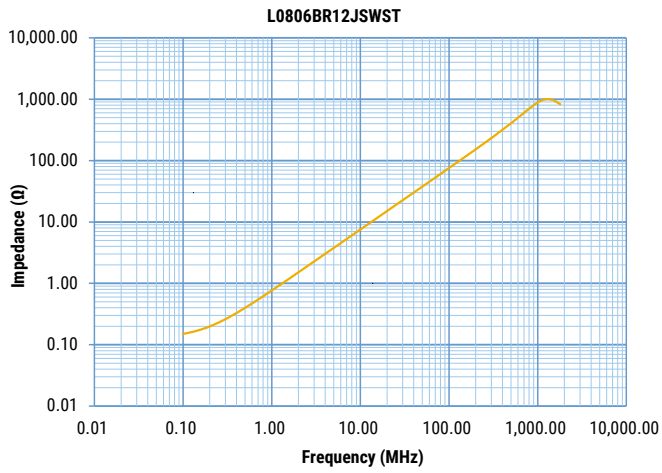

Table 1 – Ratings & Part Number Reference

Part Number	Inductance (µH)	Inductance Tolerance	Rated Current (A) ¹	DC Resistance (Ω) Typical ±30%	Q Value Minimum	Self-Resonance Frequency (MHz) Minimum	Inductance Measuring Frequency (MHz)
L0806BR12JSWST	0.12	±5 %	0.61	0.13	30	600	25.2
L0806BR15JSWST	0.15	±5 %	0.57	0.15	30	550	25.2
L0806BR18JSWST	0.18	±5 %	0.56	0.15	30	500	25.2
L0806BR22JSWST	0.22	±5 %	0.52	0.2	30	450	25.2
L0806BR27JSWST	0.27	±5 %	0.51	0.21	30	425	25.2
L0806BR33JSWST	0.33	±5 %	0.49	0.21	30	400	25.2
L0806BR39JSWST	0.39	±5 %	0.44	0.26	30	375	25.2
L0806BR47JSWST	0.47	±5 %	0.43	0.26	30	350	25.2
L0806BR56JSWST	0.56	±5 %	0.41	0.29	30	300	25.2
L0806BR68JSWST	0.68	±5 %	0.4	0.32	30	270	25.2
L0806BR82JSWST	0.82	±5 %	0.39	0.34	30	250	25.2
L0806B1R0JSWST	1.0	±5 %	0.385	0.38	30	220	7.96
L0806B1R2JSWST	1.2	±5 %	0.37	0.41	30	180	7.96
L0806B1R5JSWST	1.5	±5 %	0.35	0.47	30	135	7.96
L0806B1R8JSWST	1.8	±5 %	0.345	0.48	30	100	7.96
L0806B2R2JSWST	2.2	±5 %	0.34	0.54	30	75	7.96
L0806B2R7JSWST	2.7	±5 %	0.31	0.59	30	55	7.96
L0806B3R3JSWST	3.3	±5 %	0.29	0.68	30	48	7.96
L0806B3R9JSWST	3.9	±5 %	0.275	0.74	30	43	7.96
L0806B4R7JSWST	4.7	±5 %	0.27	0.78	30	40	7.96
L0806B5R6JSWST	5.6	±5 %	0.255	0.88	25	36	7.96
L0806B6R8JSWST	6.8	±5 %	0.24	0.97	25	33	7.96
L0806B8R2JSWST	8.2	±5 %	0.225	1.1	25	30	7.96
L0806B100JSWST	10	±5 %	0.215	1.2	25	27	2.52
L0806B120JSWST	12	±5 %	0.2	1.4	25	23	2.52
L0806B150JSWST	15	±5 %	0.19	1.5	25	20	2.52
L0806B180JSWST	18	±5 %	0.15	2.5	25	18	2.52
L0806B220JSWST	22	±5 %	0.14	2.8	25	17	2.52
L0806B270JSWST	27	±5 %	0.13	3.2	25	16	2.52
L0806B330JSWST	33	±5 %	0.125	3.6	25	15	2.52
L0806B390JSWST	39	±5 %	0.12	3.9	20	14	2.52
L0806B470JSWST	47	±5 %	0.115	4.1	20	13	2.52
L0806B560JSWST	56	±5 %	0.095	5.9	20	12	2.52
L0806B680JSWST	68	±5 %	0.09	7	20	11	2.52
L0806B820JSWST	82	±5 %	0.085	7.7	20	10	2.52
L0806B101JSWST	100	±5 %	0.08	8	15	9	0.796
Part Number	Inductance (µH)	Inductance Tolerance	Rated Current (A) ¹	DC Resistance (Ω) Typical ±30%	Q Value Minimum	Self-Resonance Frequency (MHz) Minimum	Inductance Measuring Frequency (MHz)

¹ Inductance drop within 10% and temperature rise within 20°C at rated current

Impedance versus Frequency Characteristics



Impedance versus Frequency Characteristics cont.

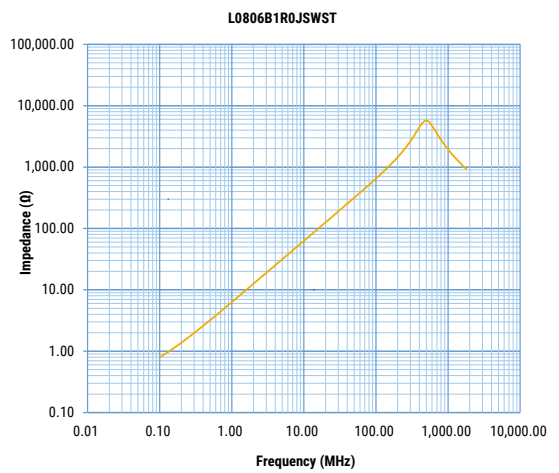
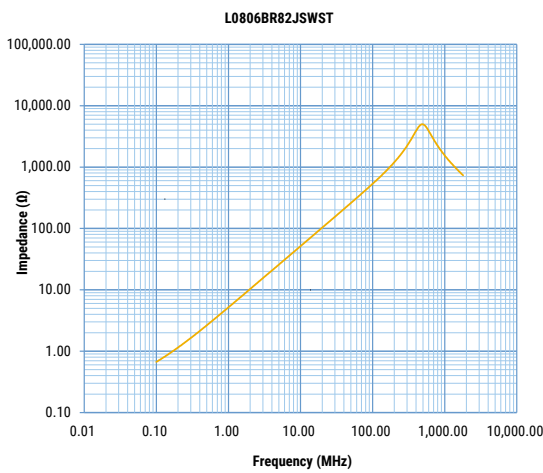
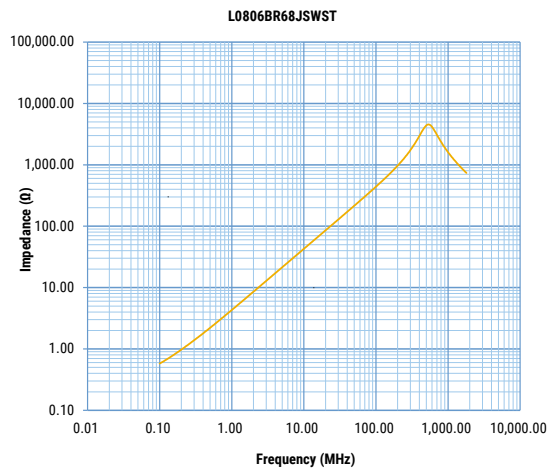
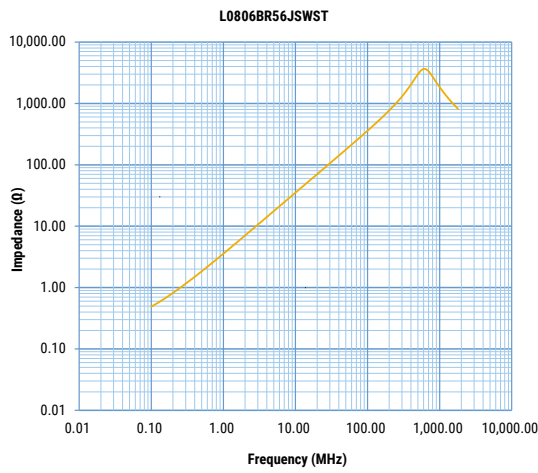
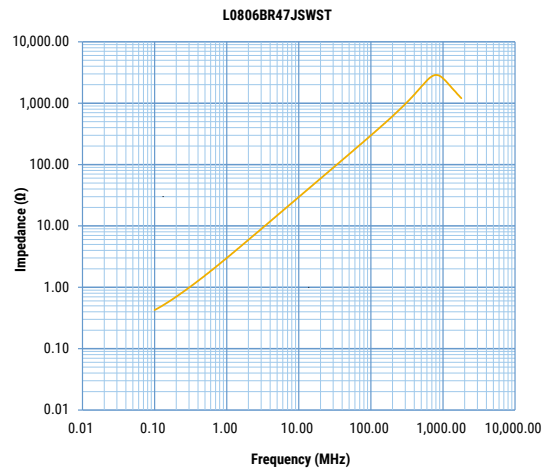
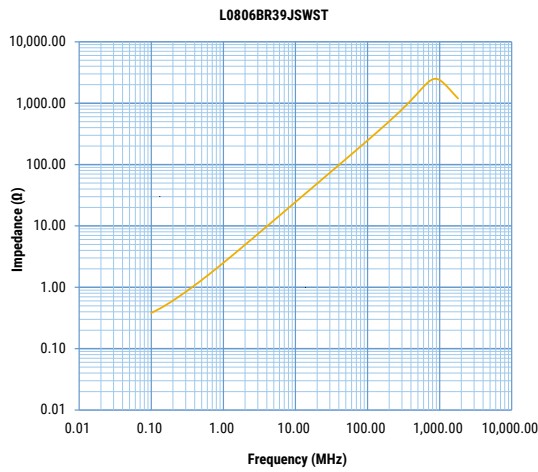

Impedance versus Frequency Characteristics cont.

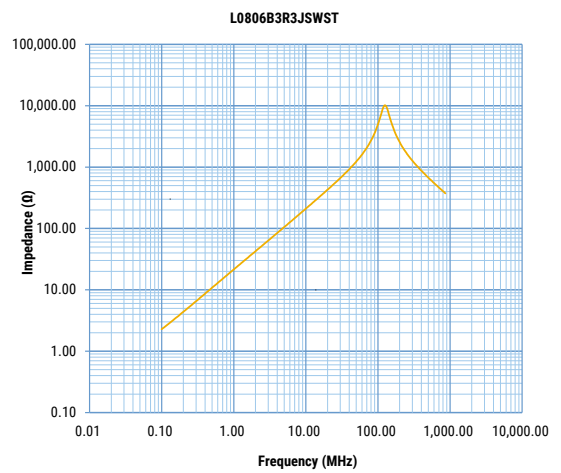
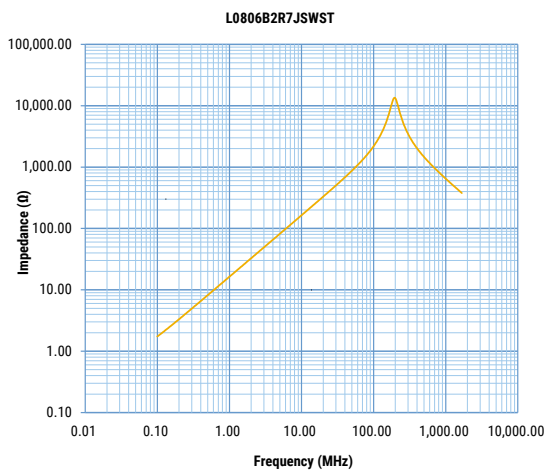
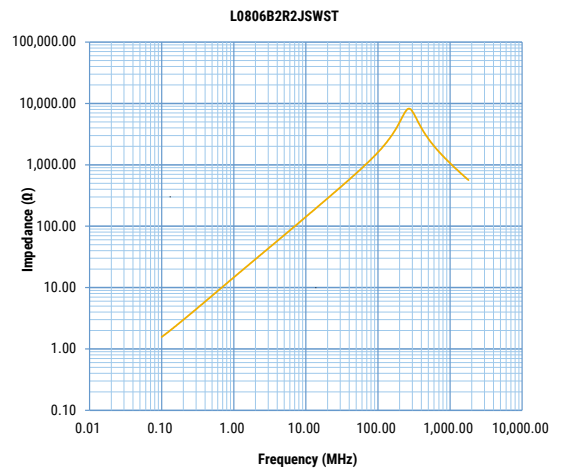
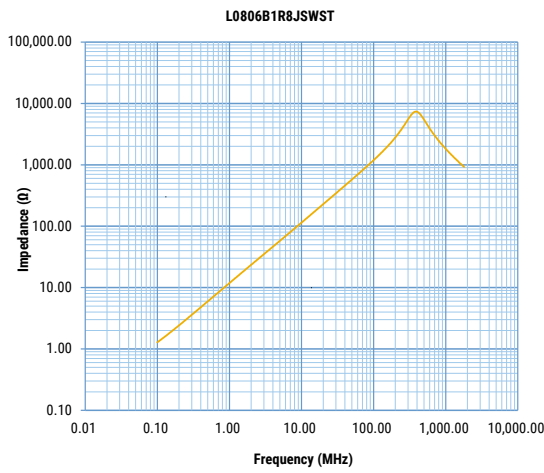
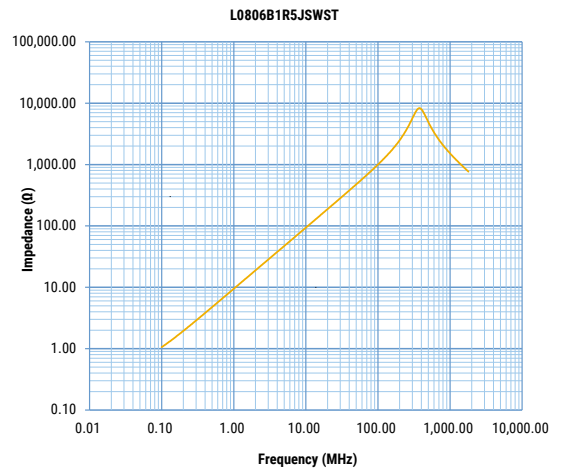
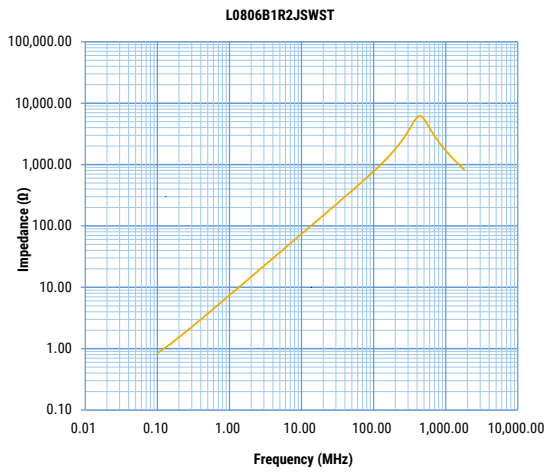

Impedance versus Frequency Characteristics cont.

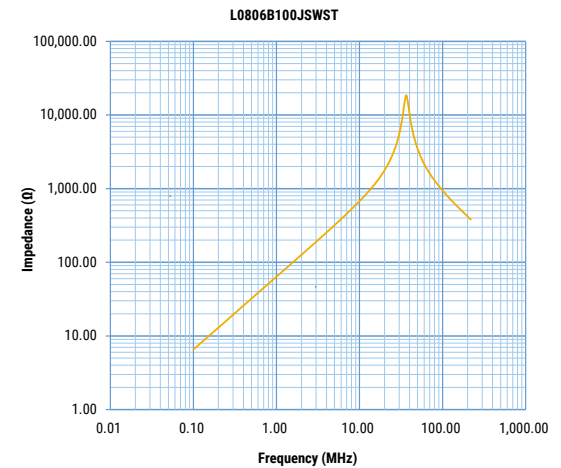
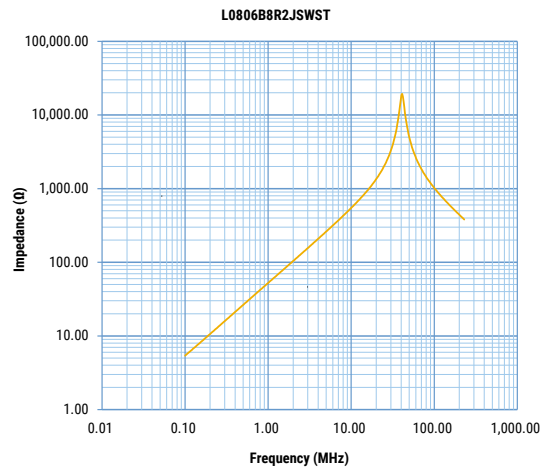
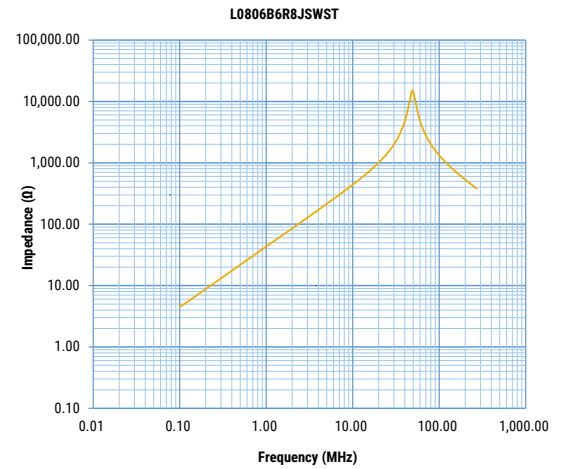
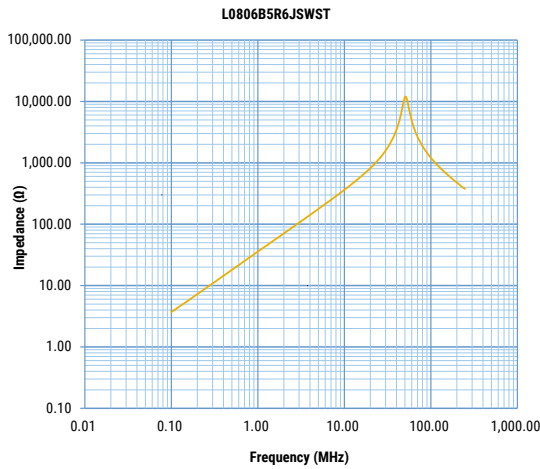
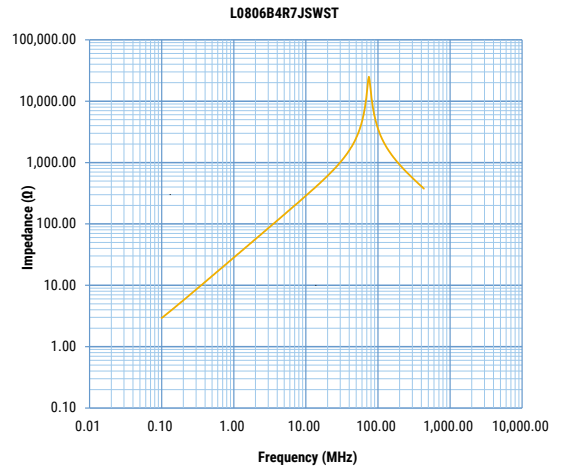
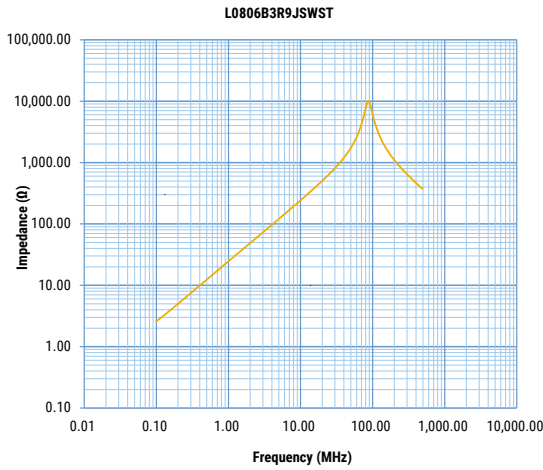

Impedance versus Frequency Characteristics cont.

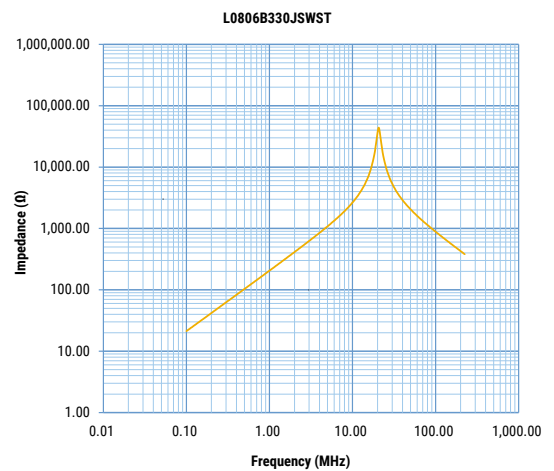
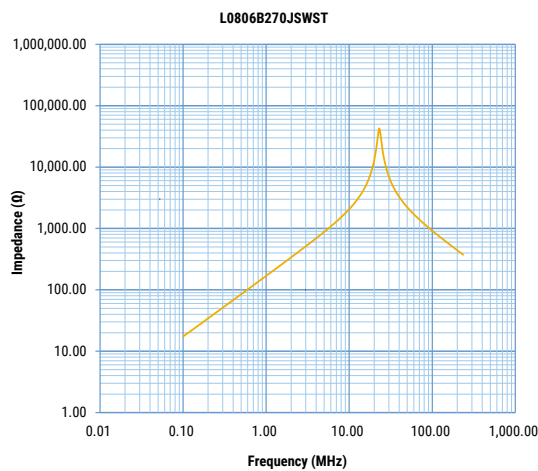
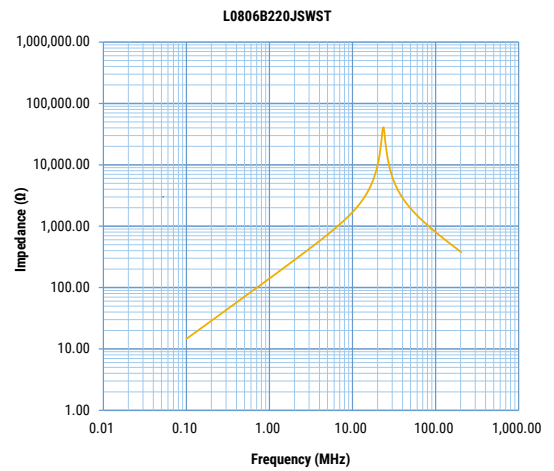
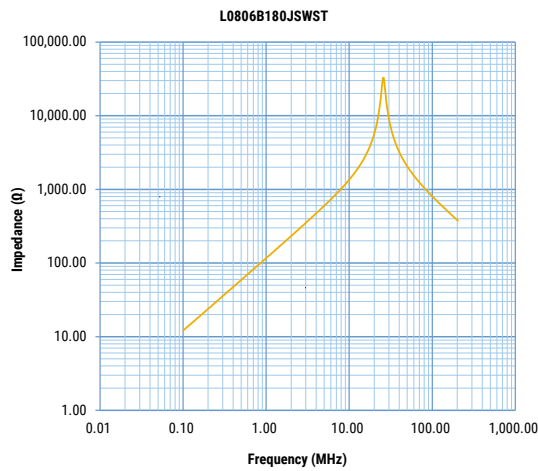
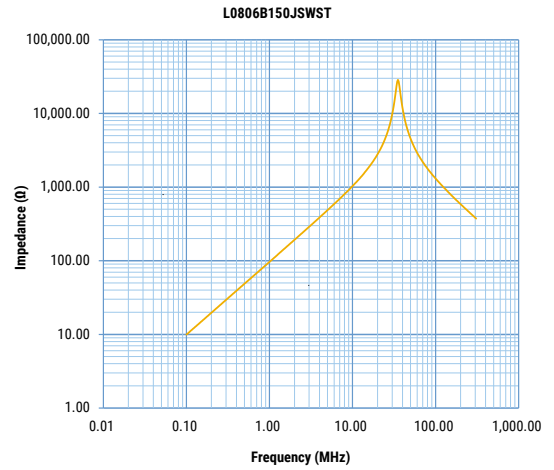
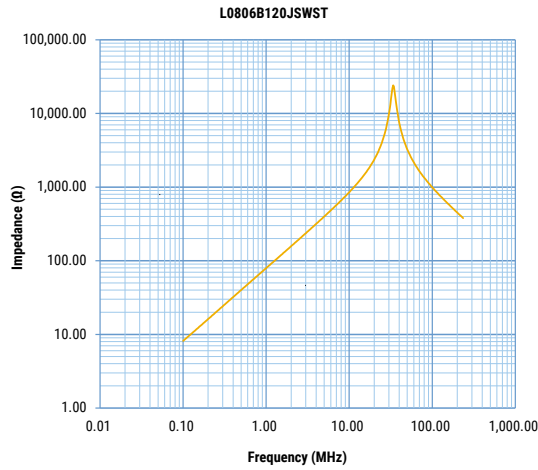

Impedance versus Frequency Characteristics cont.

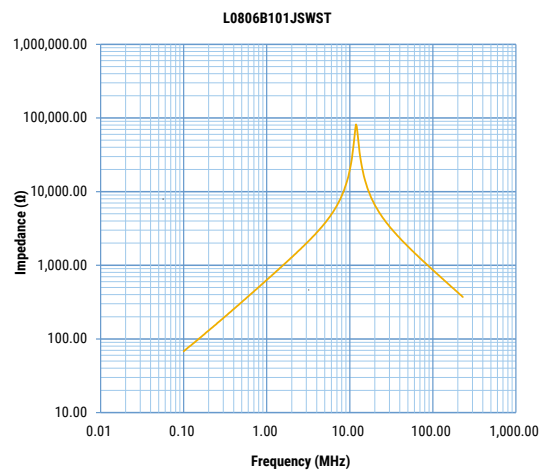
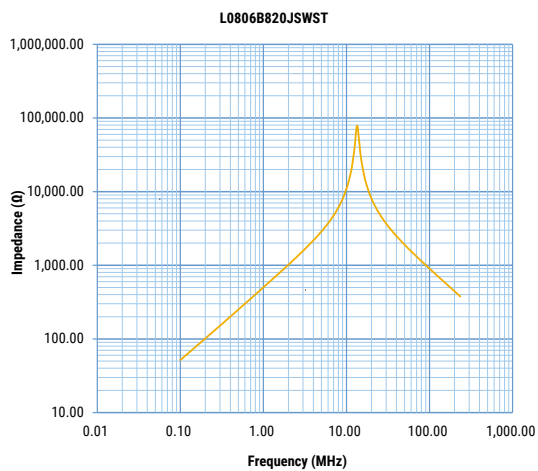
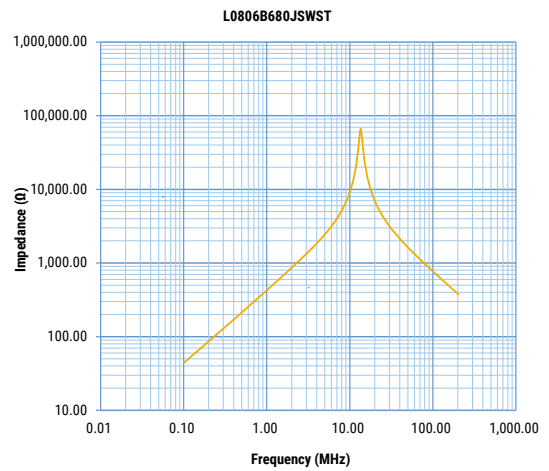
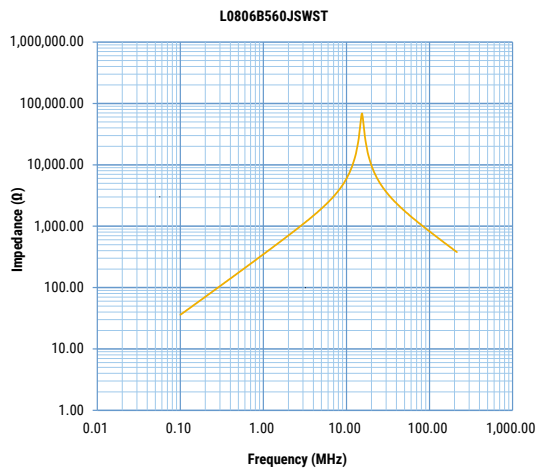
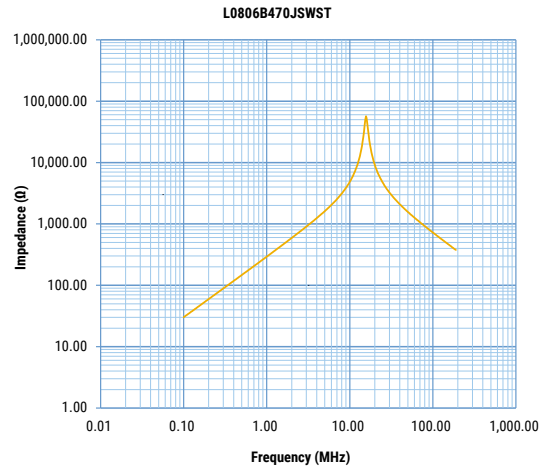
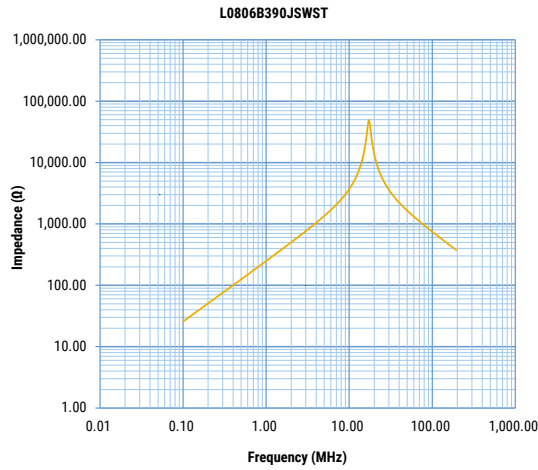

DC-Superposed Characteristics

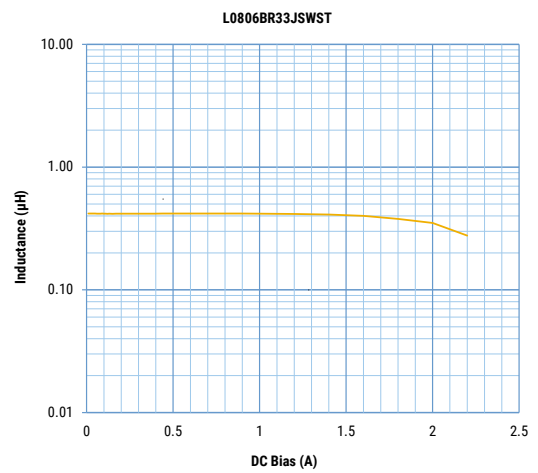
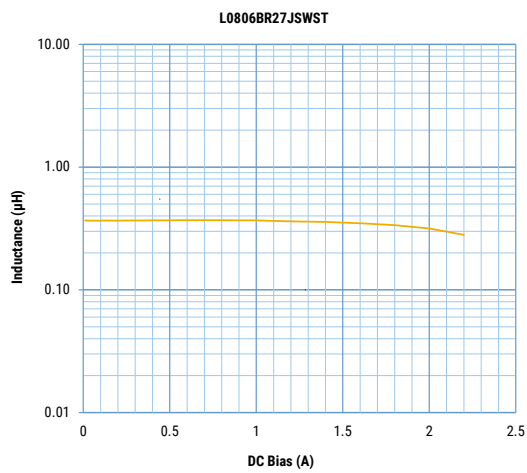
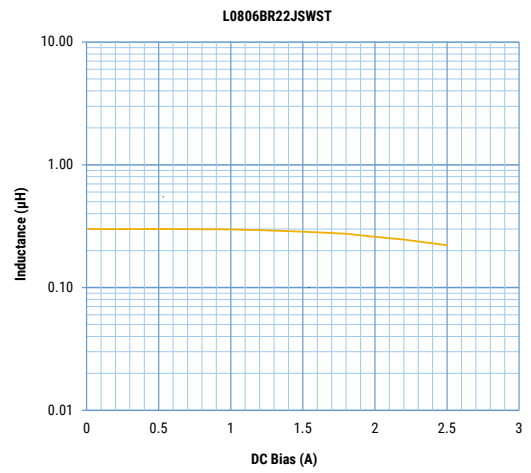
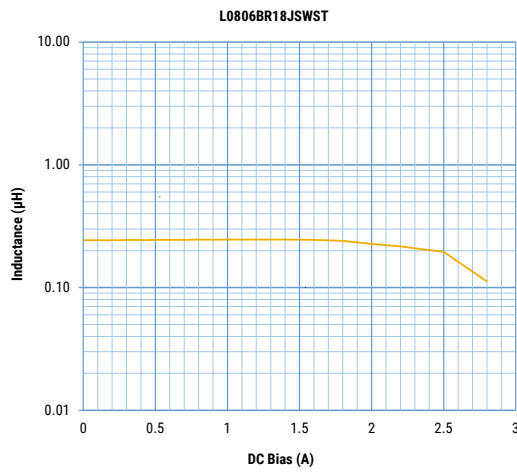
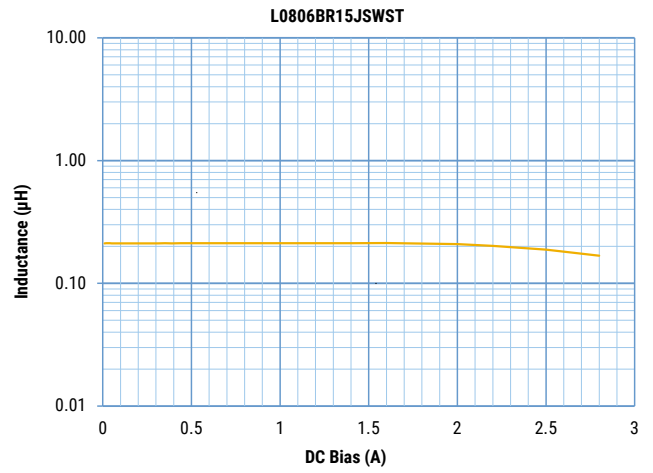
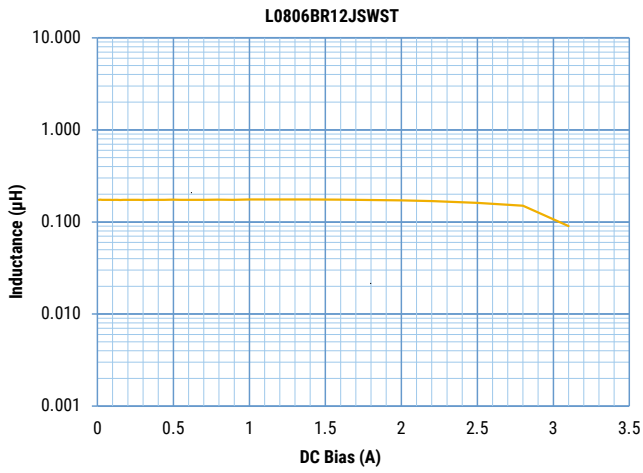

DC-Superposed Characteristics cont.

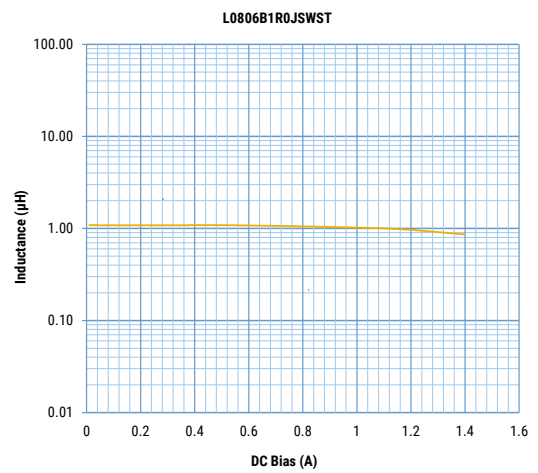
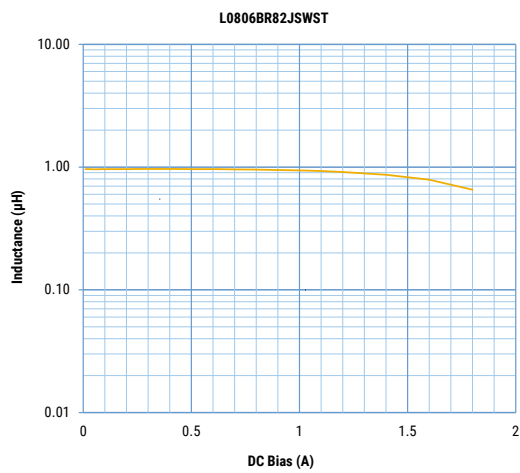
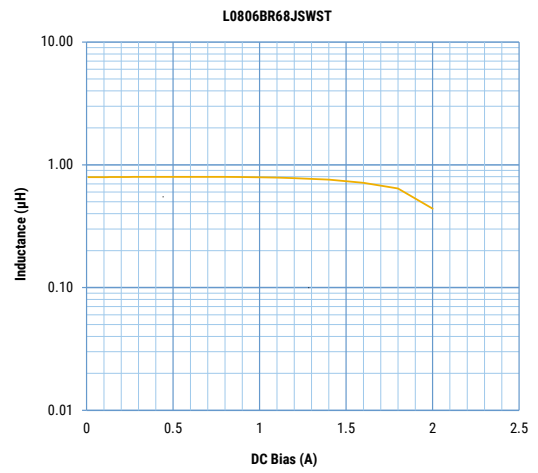
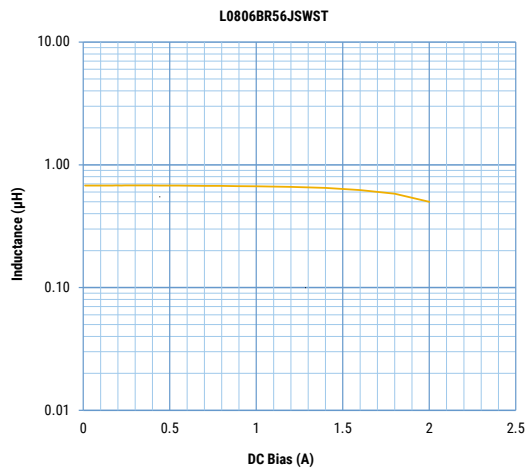
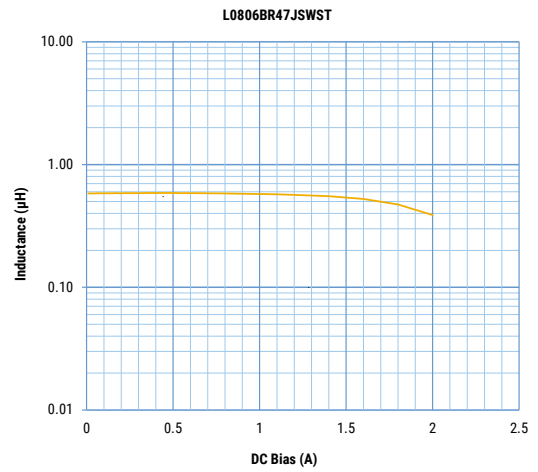
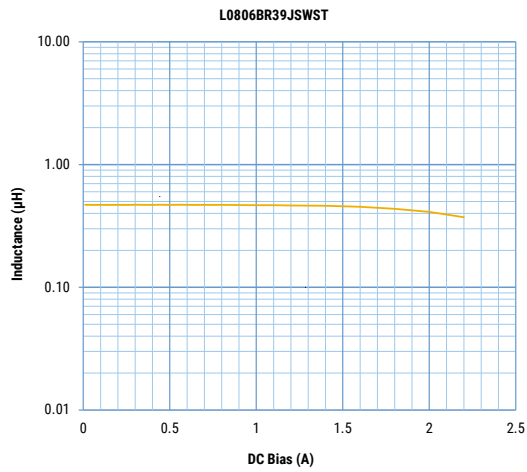

DC-Superposed Characteristics cont.

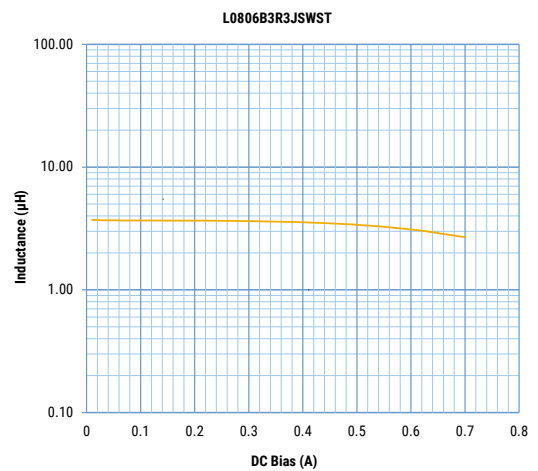
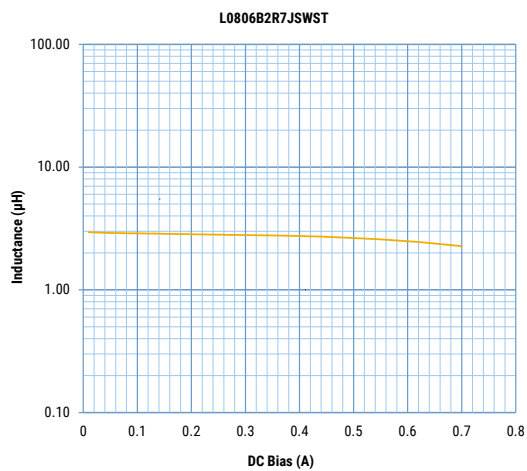
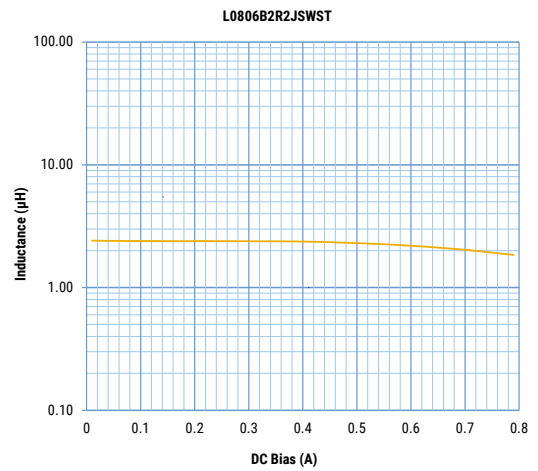
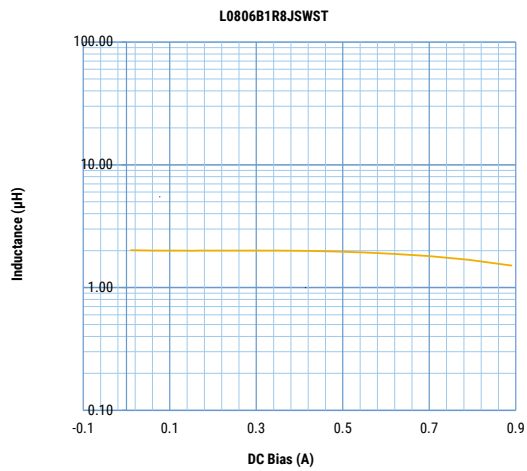
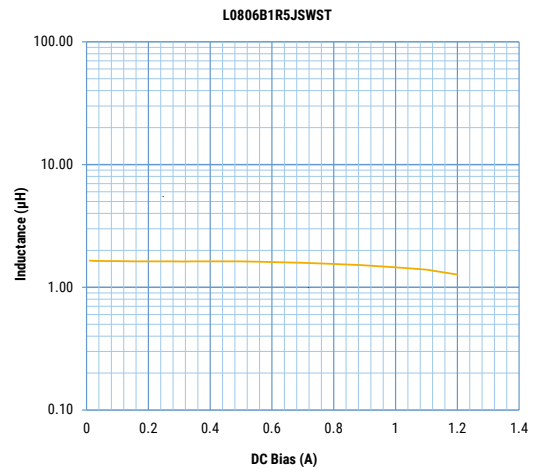
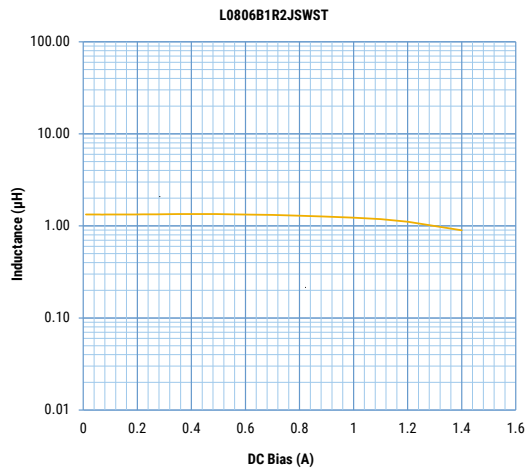

DC-Superposed Characteristics cont.

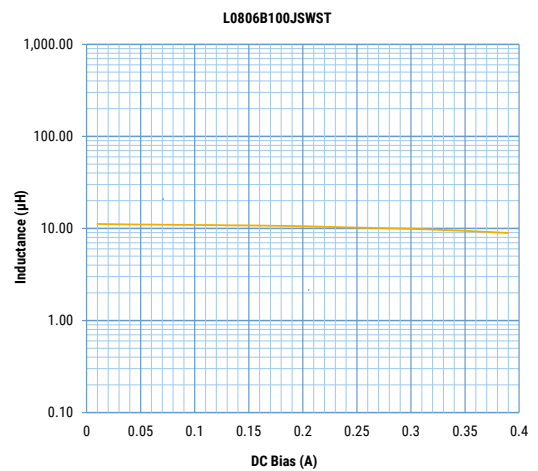
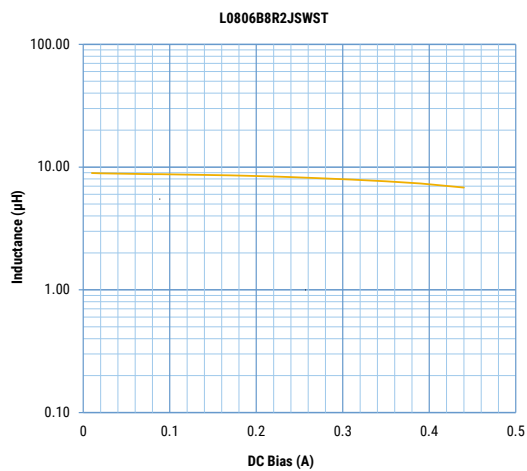
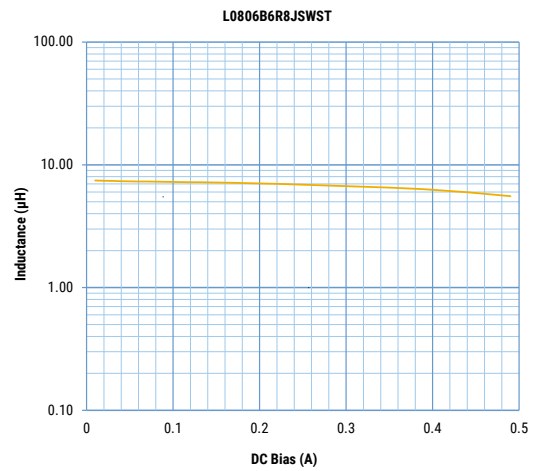
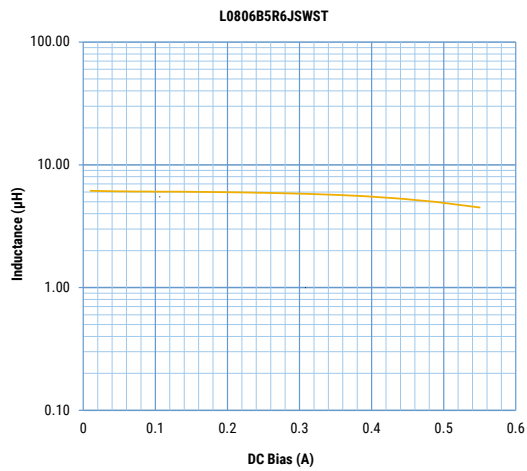
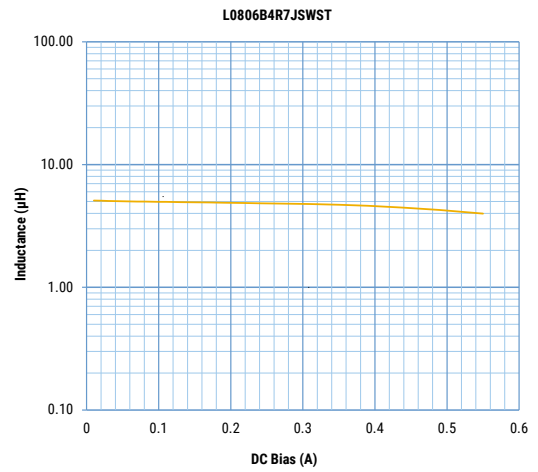
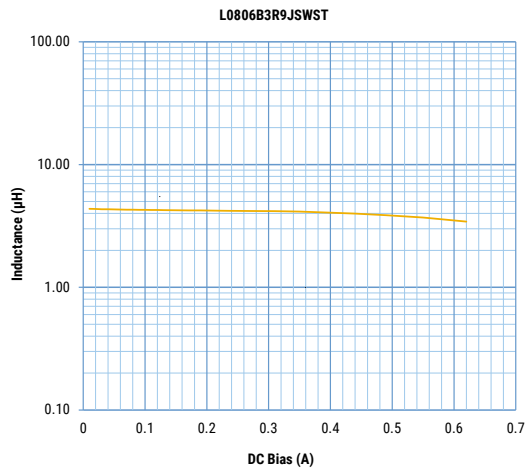

DC-Superposed Characteristics cont.

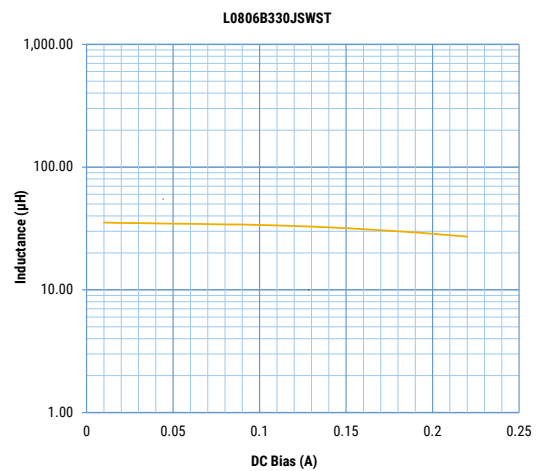
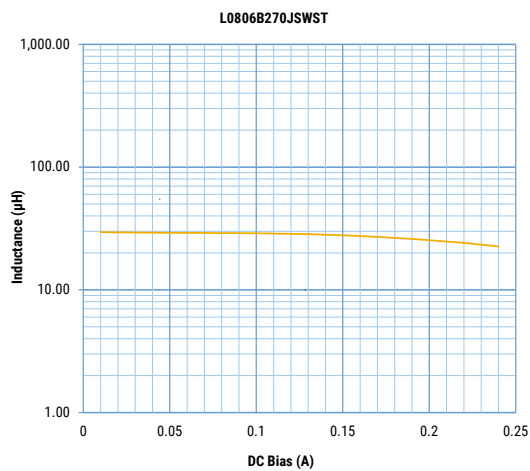
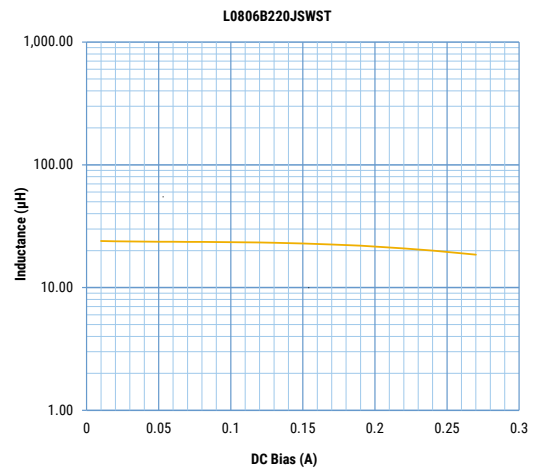
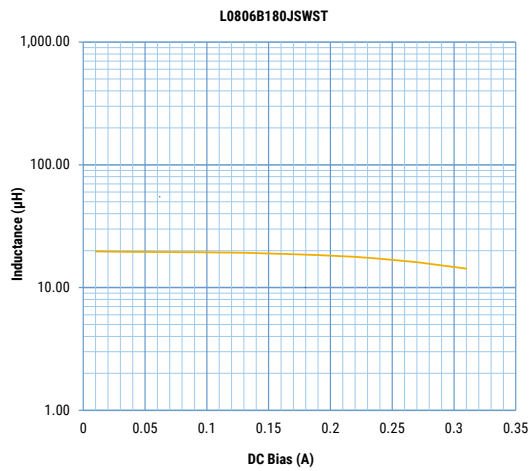
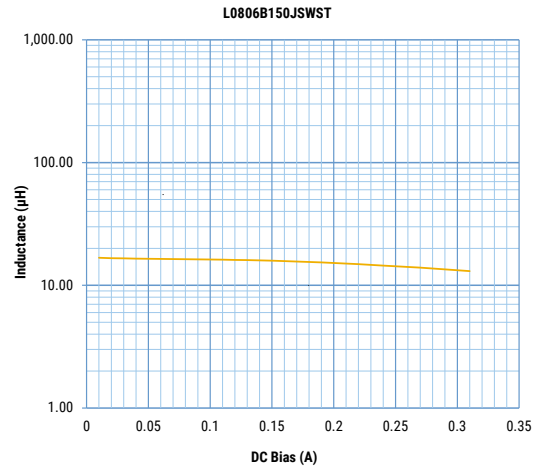
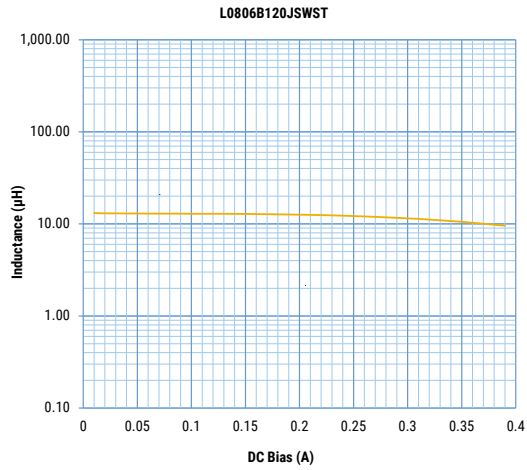

DC-Superposed Characteristics cont.

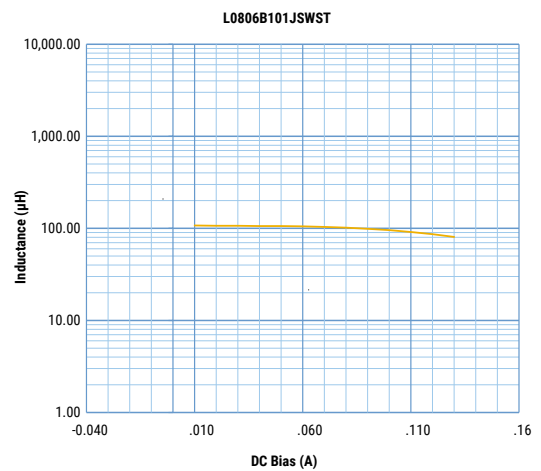
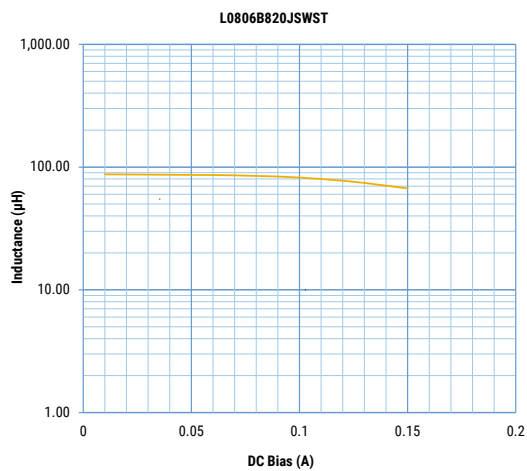
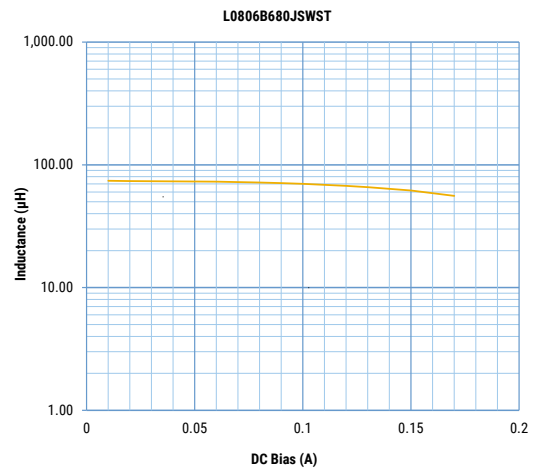
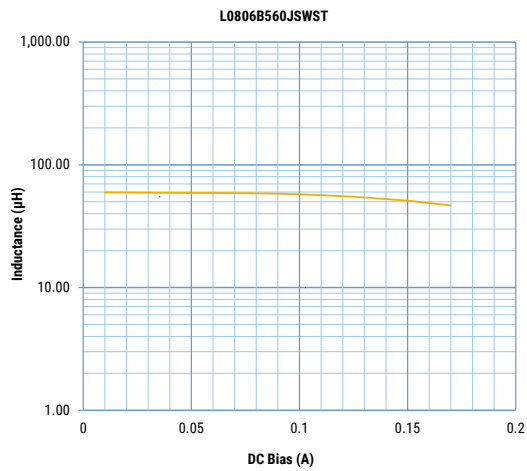
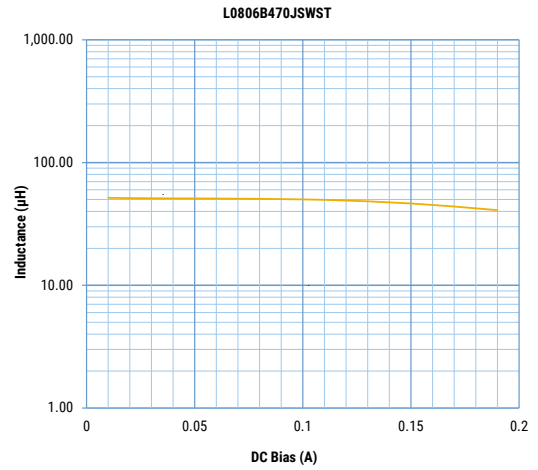
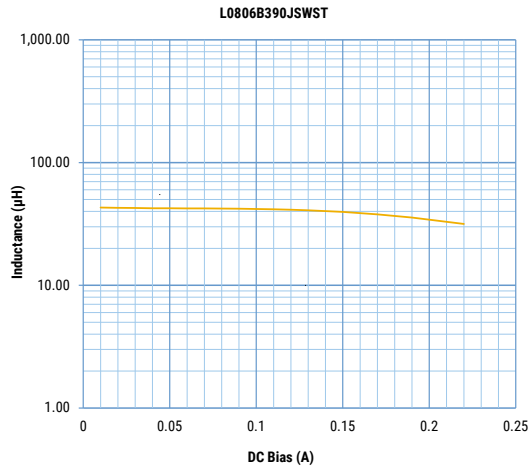

Taping Specifications - Millimeters (Inches)

0806 Embossed (Plastic) Tape 8mm Width

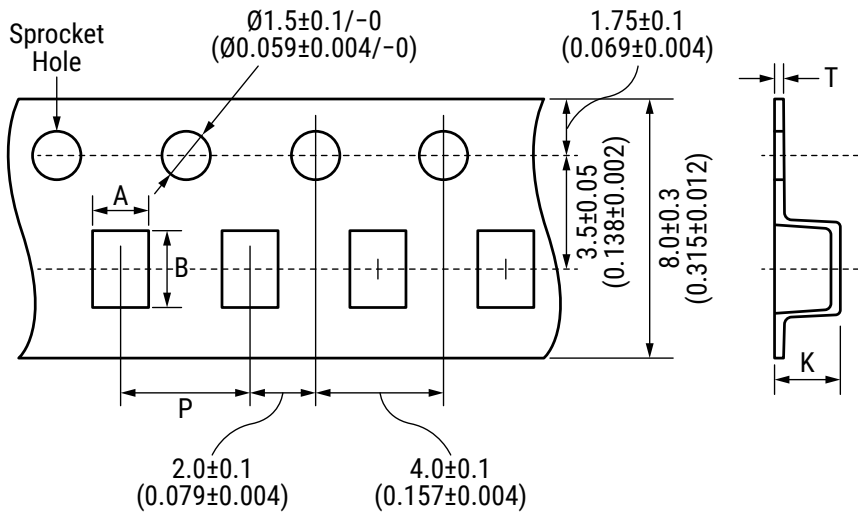

EIA Case Size	Metric Case Size	Height	Reel Quantity		Cavity		Pitch	Thickness	
					A	B	P	T	K
0806	2016	1.6	2,000	Nominal	1.75	2.10	4.00	0.30	1.90
				Tolerance	± 0.1	± 0.1	± 0.1	± 0.05	Maximum

Reel Specifications - Millimeters

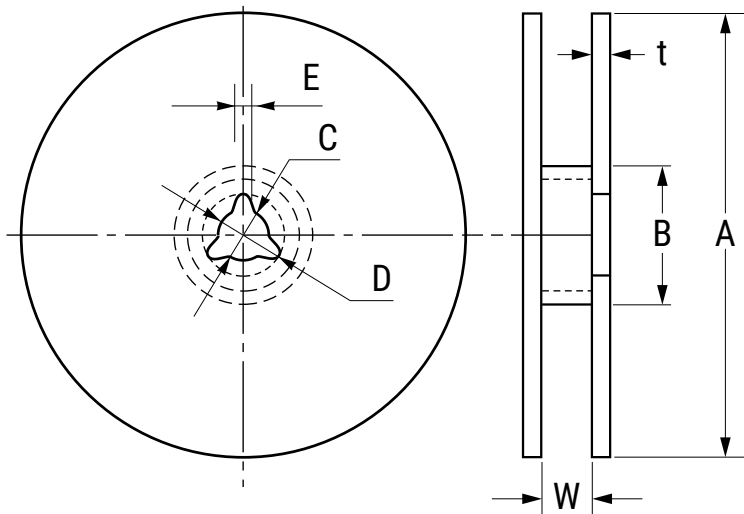

Series		Dimensions - Millimeters						
		A	B	C	D	E	t	W
L-SWS	Nominal	$\phi 180.0$	$\phi 60.0$	$\phi 13.0$	$\phi 21.0$	2.0	2.5	10.0
	Tolerance	Maximum	Minimum	± 0.5	± 0.8	± 0.5	Maximum	± 1.5

Recommended Reflow Soldering Profile

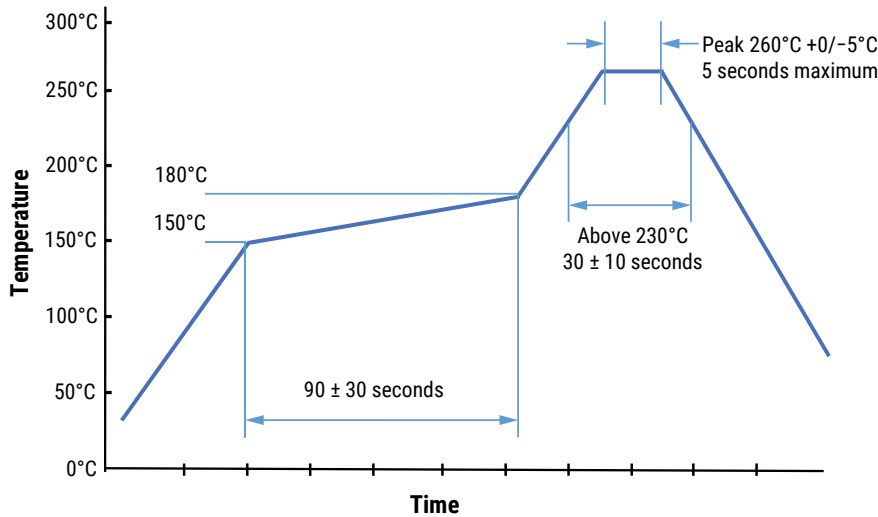

Handling Precautions

Inductors should be stored in normal working environments. While the inductors themselves are quite robust in other environments, exposure to high temperatures, high humidity, corrosive atmospheres, and long-term storage degrades solderability.

KEMET recommends that maximum storage temperature not exceed 40°C and maximum storage humidity not exceed 70% relative humidity. Atmospheres should be free of chlorine-bearing and sulfur-bearing compounds. Temperature fluctuations should be minimized to avoid condensation on the parts.

For optimized solderability, inductor stock should be used promptly, preferably within six months of receipt.

KEMET Electronics Corporation Sales Offices

For a complete list of our global sales offices, please visit www.kemet.com/sales.

Disclaimer

All product specifications, statements, information and data (collectively, the "Information") in this datasheet are subject to change. The customer is responsible for checking and verifying the extent to which the Information contained in this publication is applicable to an order at the time the order is placed. All Information given herein is believed to be accurate and reliable, but it is presented without guarantee, warranty, or responsibility of any kind, expressed or implied.

Statements of suitability for certain applications are based on KEMET Electronics Corporation's ("KEMET") knowledge of typical operating conditions for such applications, but are not intended to constitute – and KEMET specifically disclaims – any warranty concerning suitability for a specific customer application or use. The Information is intended for use only by customers who have the requisite experience and capability to determine the correct products for their application. Any technical advice inferred from this Information or otherwise provided by KEMET with reference to the use of KEMET's products is given gratis, and KEMET assumes no obligation or liability for the advice given or results obtained.

Although KEMET designs and manufactures its products to the most stringent quality and safety standards, given the current state of the art, isolated component failures may still occur. Accordingly, customer applications which require a high degree of reliability or safety should employ suitable designs or other safeguards (such as installation of protective circuitry or redundancies) in order to ensure that the failure of an electrical component does not result in a risk of personal injury or property damage.

Although all product-related warnings, cautions and notes must be observed, the customer should not assume that all safety measures are indicated or that other measures may not be required.

When providing KEMET products and technologies contained herein to other countries, the customer must abide by the procedures and provisions stipulated in all applicable export laws and regulations, including without limitation the International Traffic in Arms Regulations (ITAR), the US Export Administration Regulations (EAR) and the Japan Foreign Exchange and Foreign Trade Act.

KEMET is a registered trademark of KEMET Electronics Corporation.