

# 瓷片電容器規格承認書

## APPROVAL SPECIFICATION FOR DISC CERAMIC CAPACITORS

|                      |  |                  |              |
|----------------------|--|------------------|--------------|
| 客戶<br>CUSTOMER       | 立創   |                  |              |
| 客戶料號<br>CUSTOMER P/N | C2832508                                   |                  |              |
| 客戶規格描述<br>CUST. SPEC |  |                  |              |
| 規格描述<br>DESCRIPTION  | 50V/104/Z/F5.08/直腳/L18/酚醛(黃)/Y5V(Ⅲ)/50/ZNR |                  |              |
| 產品編碼<br>PART NUMBER  | CC1H104ZC1FD3F501100                       |                  |              |
| 日期<br>DATE           | 2021/10/26                                 | 文件編號<br>DOC. NO. | DEC-SA-WI003 |

| 德爾創承認欄<br>APPROVED BY DERSONIC |                |                    | 客戶承認欄<br>APPROVED BY CUSTOMER |                |
|--------------------------------|----------------|--------------------|-------------------------------|----------------|
| 批准<br>APPROVED BY              | 審核<br>CHECK BY | 制訂<br>FORMULATE BY | 批准<br>APPROVED BY             | 審核<br>CHECK BY |
| 彭少雄                            | <br>吳成愛        | 陳冬花                |                               |                |

### 東莞市德爾創電子有限公司

#### DONGGUAN DERSONIC ELECTRONIC CO., LTD.



廣東省東莞市長安鎮錦廈河南工業區錦平路5號

No. 5, Jinping Rd., Jinxia Henan Industrial Zone, Changan Town, Dongguan City

TEL: +86-769-8155 5686

FAX: +86-769-8155 5989

E-mail: sales@dersonic.com / quality@dersonic.com

Website: <http://www.dersonic.com>

**瓷片電容器規格承認書**  
**APPROVAL SPECIFICATION FOR DISC CERAMIC CAPACITORS**

**目 錄**  
**CONTENTS**

|  |       |    |
|--|-------|----|
| 1. 規格表<br>DATA SHEET                             | ..... | 2  |
| 2. 總則<br>GENERAL                                 | ..... | 3  |
| 3. 適用標準<br>APPLICABLE STANDARD                   | ..... | 3  |
| 4. 產品結構<br>STRUCTURE                             | ..... | 3  |
| 5. 產品編碼<br>PART NUMBER                           | ..... | 4  |
| 6. 測量和試驗<br>MEASUREMENT AND TEST                 | ..... | 5  |
| 7. 包裝和儲存<br>PACKAGING AND STORAGE                | ..... | 7  |
| 8. 測量和使用注意事項<br>MEASURING AND APPLICATION NOTICE | ..... | 8  |
| 9. 編帶尺寸規格<br>TAPING SPECIFICATIONS               | ..... | 10 |



請確保我們的產品安裝到您的產品上前，已根據您的需求進行了評估。  
Please make sure that your product has been evaluated in view of your specifications with our product being mounted to your product.  
請您在使用我們的產品時，不要偏離此標準。  
You are requested not to use our product deviating from this specification.

**瓷片電容器規格承認書**
**APPROVAL SPECIFICATION FOR DISC CERAMIC CAPACITORS**

## 1. 規格表

## DATA SHEET

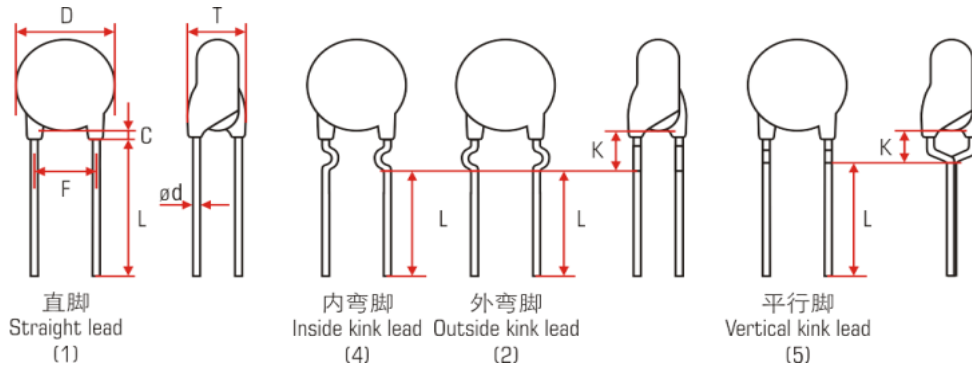

|                                     |  |                |
|-------------------------------------|--|----------------|
| 產品編碼<br>Part number                 | CC1H104ZC1FD3F501100                             |                |
| 規格描述<br>Description                 | 50V/104/Z/F5.08/直脚/L18/酚醛(黃)/Y5V(III)/50/ZNR     |                |
| 客戶料號<br>Customer P/N                | C2832508   |                |
| 介質類別<br>Dielectric class            | Class 3 (Surface insulation type)                |                |
| 額定電壓<br>Rated voltage               | 50VDC  |                |
| 電容量<br>Capacitance                  | 0.1uF+80%/-20% @ 1kHz 0.1Vrms 25°C               |                |
| 損耗角正切<br>Tangent of loss angle      | 0.05 max @1kHz 0.1Vrms 25°C                      |                |
| 耐電壓<br>Testing voltage              | 50VDC (Charge/discharge current 1mA max) 3s PASS |                |
| 絕緣電阻<br>Insulation resistance       | 50MΩ min @ 25V 60s, RH<70%                       |                |
| 溫度特性<br>Temperature characteristics | Y5V(III)<br>ΔC/C: +22/-82% @ -25°C~85°C          |                |
| 尺寸<br>DIMENSIONS                    | D (Diameter)                                     | 5.5mm ± 0.5mm  |
|                                     | T (Thickness)                                    | 2.4mm ± 0.6mm  |
|                                     | F (Lead spacing)                                 | 5.08mm ± 0.8mm |
|                                     | L (Lead length)                                  | 18mm ± 4.0mm   |
|                                     | ød (Lead diameter)                               | 0.55mm max     |
|                                     | C (Coating rundown on lead)                      | 1.5mm max      |
| 標誌<br>Marking                       | ZNR<br>104<br>—                                  |                |

## 瓷片電容器規格承認書

### APPROVAL SPECIFICATION FOR DISC CERAMIC CAPACITORS

#### 2. 總則

##### GENERAL

- 1) 本規格書適用於額定電壓不超過直流8kV或最大標稱電容量為0.22uF的電子設備用瓷片電容器。  
This specification applies to the disc ceramic capacitors for electronic equipment with a rated voltage not exceeding DC 8kV or 0.22uF of maximum nominal capacitance .
- 2) 溫度補償型(1類瓷)電容器是專門設計並用在低損耗、電容量穩定性高或要求溫度系數有明確規定的諧振電路中的一種電容器，例如，在電路中作溫度補償之用。  
Temperature compensation (Class 1) ceramic capacitor specially designed and suited for resonant circuit application where low losses and high stability of capacitance are essential or where a precisely defined temperature coefficient is required, for example for compensating temperature effects in the circuit.  
該類陶瓷介質是由標稱溫度系數 ( alpha ) 來確定，如NP0、N750、SL等等。  
The ceramic dielectric is defined by its rated temperature coefficient (alpha), such as NP0, N750, SL, etc. .
- 3) 高介電常數型(2類瓷)電容器是適用於作旁路、耦合或用在對損耗和電容量穩定性要求不高的電路中的具有高介電常數的一種電容器。  
High dielectric (Class 2) ceramic capacitor which has a dielectric with a high permittivity and is suitable for by-pass and coupling applications or for frequency discriminating circuits where low losses and high stability of capacitance are not of major importance.  
該類陶瓷介質是以在類別溫度範圍內電容量非線性變化來表征，如Y5P、Y5U、Y5V等等。  
The ceramic dielectric is characterized by the non-linear change of capacitance over the category temperature range, such as Y5P, Y5U and Y5V etc.
- 4) 可適用於自動化生產線  
Cost-saving automatic insertion available
- 5) 符合RoHS 2.0、REACH標準，無鹵。  
Comply with RoHS 2.0 & REACH, halogen-free available

#### 3. 適用標準

##### APPLICABLE STANDARD

本產品符合下列標準，且本規格書的相關內容引用以下標準，當雙方對此存在爭議時，可依以下標準進行仲裁。  
This product complies with the following standards, and the relevant content of this specification refers to the following standards, when the two sides in dispute, the following criteria for arbitration.

- GB/T 2693-2001 電子設備用固定電容器 第1部分 總規範(IDT IEC 60384-1)  
Fixed capacitors for use in electronic equipmen — Part 1: Generic specification (IDT IEC 60384-1)
- GB/T 5966-2011 電子設備用固定電容器 第8部分 分規範 1類瓷介固定電容器(IDT IEC 60384-8)  
Fixed capacitors for use in electronic equipmen — Part 8: Sectional specification: Fixed capacitors of ceramic dielectric, Class 1 (IDT IEC 60384-8)
- GB/T 5968-2011 電子設備用固定電容器 第9部分 分規範 2類瓷介固定電容器(IDT IEC 60384-9)  
Fixed capacitors for use in electronic equipmen — Part 9: Sectional specification: Fixed capacitors of ceramic dielectric, Class 2 (IDT IEC 60384-9)

#### 4. 結構

##### STRUCTURE

本產品結構如下圖所示，外部包封層為環氧樹脂（藍色）或酚醛樹脂（土黃色），內部介質為陶瓷，銀電極，導線為鍍錫銅包鋼線，電極與導線採用無鉛錫焊接而成，經過激光打標而成。

The structure of this product is shown in the following figure, external coating layer to epoxy resin (blue) or phenolic resin (yellowish), internal dielectric for ceramics, silver electrodes, lead wires for tin-plated copper clad steel wire, electrodes and lead wires using lead-free tin soldering, through laser marking.

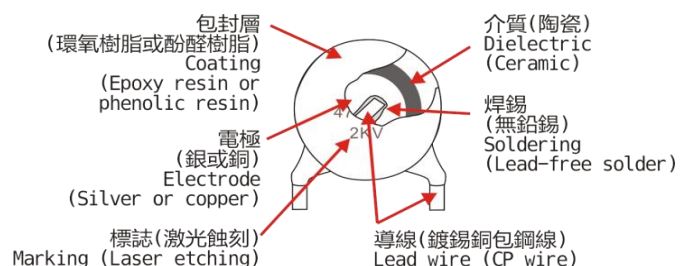

## 瓷片電容器規格承認書

### APPROVAL SPECIFICATION FOR DISC CERAMIC CAPACITORS

#### 5. 產品編碼

##### PART NUMBER

本公司產品編碼方式，舉例說明如下：

The product part number representation of the company, examples are as follows:

|                           |   |   |                                    |                                    |  |                           |  |  |                             |
|---------------------------|---|---|------------------------------------|------------------------------------|--|---------------------------|--|--|-----------------------------|
| <b>CC</b><br>系列<br>Series | <b>1H</b><br>額定直流電壓<br>Rated dc voltage | <b>104</b><br>標稱容量<br>Nominal capacitance | <b>Z</b><br>容量偏差<br>Cap. tolerance | <b>C1</b><br>引線成型方式<br>Lead format | <b>F</b><br>編帶包裝或腳長<br>Taping packing or Lead length | <b>D</b><br>包封<br>Coating | <b>3F</b><br>溫度特性<br>Temperature characteristics | <b>501</b><br>內部識別碼<br>Inter identification code | <b>100</b><br>標誌<br>Marking |
|---------------------------|---|---|------------------------------------|------------------------------------|--|---------------------------|--|--|-----------------------------|

##### ■ 系列 Series

**CC: 瓷片電容器**  
Disc ceramic capacitors

##### ■ 額定直流電壓 Rated dc voltage

|         |                |          |                 |           |
|---------|----------------|----------|-----------------|-----------|
| 1C: 16V | <b>1H: 50V</b> | 2E: 250V | 3A: 1kV         | 3G: 4kV   |
| 1E: 25V | 1J: 63V        | 2H: 500V | 3D: 2kV         | 3H: 5kV   |
| 1V: 35V | 2A: 100V       | 2J: 630V | 3F: 3kV(3.15kV) | 3J: 6.3kV |
|         | 2D: 200V       |          |                 | 3K: 8kV   |

##### ■ 標稱容量 Nominal capacitance

用3位數表示，單位pF。如下所示：  
In 3 digits, unit is pF, as shown in below:  
**104: 0.1uF ( 1 uF = 1 000 nF = 1 000 000 pF )**

##### ■ 容量偏差 Capacitance tolerance

|            |         |                     |
|------------|---------|---------------------|
| C: ±0.25pF | J: ±5%  | S: +50%/-20%        |
| D: ±0.50pF | K: ±10% | <b>Z: +80%/-20%</b> |
|            | M: ±20% | P: +100%/-0%        |

##### ■ 引線成型方式 Lead format

| 代碼<br>Code | 腳距<br>Lead spacing |
|------------|--------------------|
| A          | 2.54mm             |
| <b>C</b>   | <b>5.08mm</b>      |
| D          | 7.50mm             |
| E          | 10.0mm             |

| 代碼<br>Code                           | 1                      | 2                           | 4                          | 5                            | 7                                     |
|--------------------------------------|------------------------|-----------------------------|----------------------------|------------------------------|---------------------------------------|
| 腳型<br>樣式<br>Lead<br>style<br>drawing |                        |                             |                            |                              |                                       |
|                                      | 直腳<br>Straight<br>Lead | 外彎腳<br>Outside<br>kink Lead | 內彎腳<br>Inside kink<br>Lead | 平行腳<br>Vertical<br>kink Lead | 小單外彎腳<br>Mini<br>outside<br>kink Lead |

##### ■ 編帶包裝或腳長 Taping packing or Lead length

|                             |          |          |                |
|-----------------------------|----------|----------|----------------|
| <b>● Bulk (Lead length)</b> | 4: 3.5mm | 9: 6.0mm | <b>F: 18mm</b> |
|                             | 5: 3.8mm | V: 7.0mm | G: 20mm        |
|                             | 6: 4.0mm | A: 8.0mm | I: 24mm        |
|                             | 7: 4.5mm | B: 10mm  | 2: 3.0mm       |
|                             | 8: 5.0mm | E: 16mm  | 3: 3.2mm       |

##### ● Taping

T: Reel packing  
卷盤包裝

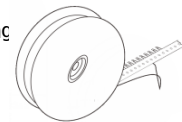

P: Ammo packing  
折疊包裝

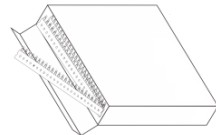

##### ■ 包封 Coating

**D: 酚醛 (黃)**  
Phenolic (Yellow)

E: 環氧 (藍)  
Epoxy (Blue)

##### ■ 溫度特性 Temperature characteristics

|                 |         |                |         |           |
|-----------------|---------|----------------|---------|-----------|
| Class 1:        | CH: NP0 | UJ: N750       | SL: SL  | DL: N3300 |
| Class 2:        | B4: Y5P | E4: Y5U        | F4: Y5V | R1: X7R   |
| <b>Class 3:</b> | 3E: Y5U | <b>3F: Y5V</b> |         |           |

##### ■ 內部識別碼 Inter identification code

內部控制碼，本規格書不作說明。  
Inter control code will not be described in this an approval specifications.

##### ■ 標誌 Marking

見規格表最後一欄  
See the last column of the "DATA SHEET"

## 瓷片電容器規格承認書

### APPROVAL SPECIFICATION FOR DISC CERAMIC CAPACITORS

#### 6. 測量和試驗

#### MEASUREMENT AND TEST

| No. | 項目<br>Item  | 標準<br>Specifications   | 試驗方法<br>Testing Method  |
|-----|---|--|---|
| 1   | 工作溫度範圍<br>Operating temp. range                     | -25°C~85°C   |   |
| 2   | 額定電壓<br>Rated voltage<br>( $U_R$ )                  | 50VDC  | 額定電壓是指在工作溫度範圍內，可連續施加在電容器上的最大直流電壓或最大交流電壓有效值或脈沖電壓的峰值當交流電壓附加於直流電壓時， $V_p-p$ 或 $V_o-p$ （以較大者為準）應維持在額定電壓範圍內。<br>The rated voltage is defined as the maximum voltage which may be applied continuously to the capacitor within the operating temperature range. When AC voltage is superimposed on DC voltage, $V_p-p$ or $V_o-p$ , whichever is larger, should be maintained within the rated voltage range. |
| 3   | 外觀與尺寸<br>Appearance (APP)<br>and Dimension          | 外觀形狀沒有明顯的缺點，尺寸在標準範圍內。<br>No marked defect on appearance form and dimensions are within specified range.                                    | 電容必須用目視檢查其明顯的缺點。<br>The capacitor should be visually inspected for evidence of defect.<br>尺寸用遊標卡尺測量。<br>Dimensions should be measured with slide calipers.  |
| 4   | 標誌<br>Marking                                       | 清晰易於識別。<br>To be easily legible.   | 目視檢查。<br>The capacitor should be visually inspected.  |
| 5   | 容量 ( $C_R$ )<br>Capacitance ( $C_R$ )               | 0.08uF~0.18uF  | 容量與 $\tan \delta$ 在 $25 \pm 1^\circ\text{C}$ 下，使用1kHz和1Vrms下測量。<br>The capacitance, $\tan \delta$ should be measured at $25^\circ\text{C} \pm 1^\circ\text{C}$ with 1kHz and 1.0V (r.m.s.).   |
| 6   | 損耗角正切<br>Tangent of loss angle<br>( $\tan \delta$ ) | 0.05 max   |   |
| 7   | 絕緣電阻<br>Insulation Resistance<br>(IR)               | 50M $\Omega$ min   | 在兩導線間施加下列電壓進行測量，時間不超過1分鐘。<br>The insulation resistance should be measured with a test voltages of below at normal temperature and humidity and less than 1 min. of charging.<br>25V @ RH<70%  |
| 8   | 耐電壓<br>Testing Voltage<br>(TV)                      | 沒有不合格<br>No failure.   | 在電容器兩導線間施加下列測試電壓（充/放電流不大於2mA）1到5s後不被破壞。<br>The capacitor should not be damaged when test voltages (Charge/Discharge current $\leq 2\text{mA}$ ) of below are applied between the lead wires for 1 to 5 sec.<br>50V dc   |
| 9   | 導線抗張強度<br>Terminal Tensile<br>Strength              | 引線不應斷開，電容器不應破裂。<br>Lead wire should not be cut off capacitor should not be broken.   | 固定住電容器，在引線上逐步施加徑嚮拉力直至10N，並保持 $10 \pm 1$ 秒鐘。<br>Fix the body of the capacitor and apply a tensile weight gradually to each lead wire in the radial direction of the capacitor up to 10N and keep it for $10 \pm 1$ sec.  |
| 10  | 導線抗折強度<br>Terminal Bending<br>Strengt               | 引線不應斷開，電容器不應破裂。<br>Lead wire should not be cut off capacitor should not be broken.   | 在引線出口處沿一個方嚮施加5N、90°的彎曲壓力，再恢復至初始狀態。之後，在2至3秒內再以相反方嚮施加一次90°的彎曲壓力。<br>Each lead wire should be subjected to 5N of weight and bent 90° at the point of egress, in one direction, then returned to its original position and bent 90° in the opposite direction at the rate of one bent in 2 to 3 sec.  |
| 11  | 可焊性<br>Solderability of Lead                        | 導線必須有3/4以上的面積均勻附着焊錫<br>Lead wire should be soldered with uniform coating on the axial direction over 3/4 of the circumferential direction. | 引線必須浸入焊料中 $3 \pm 0.5$ 秒鐘，浸入深度離導線根部1.5-2.0mm。<br>The lead wire of a capacitor should be dipped into molten solder for $3 \pm 0.5$ sec. The depth of immersion is up to about 1.5 to 2.0mm from the root of lead wires.<br>焊錫溫度：無鉛焊(Sn-3Ag-0.5Cu) $245 \pm 5^\circ\text{C}$<br>Temp. of solder: Lead Free Solder (Sn-3Ag-0.5Cu) $245 \pm 5^\circ\text{C}$   |

## 瓷片電容器規格承認書

### APPROVAL SPECIFICATION FOR DISC CERAMIC CAPACITORS

續上表  
Continued on the table

| No.  | 項目<br>Item                            | 標準<br>Specifications              | 試驗方法<br>Testing Method   |      |                                       |   |     |   |                            |   |     |   |                            |   |     |
|------|---------------------------------------|-----------------------------------|--|------|---------------------------------------|---|-----|---|----------------------------|---|-----|---|----------------------------|---|-----|
| 12   | 焊錫耐熱性<br>Soldering Effect             | APP                               | 沒有可見損傷<br>No marked defect   |      |                                       |   |     |   |                            |   |     |   |                            |   |     |
|      |                                       | $\Delta C/C$                      | $\pm 20\%$   |      |                                       |   |     |   |                            |   |     |   |                            |   |     |
|      |                                       | IR                                | 大於初始標準的50%<br>More than 50% initial specified value.   |      |                                       |   |     |   |                            |   |     |   |                            |   |     |
|      |                                       | TV                                | 如第8項進行試驗，沒有不合格<br>Per Item 8.  |      |                                       |   |     |   |                            |   |     |   |                            |   |     |
| 13   | 振動<br>Vibration Resistance            | APP                               | 沒有可見損傷<br>No marked defect   |      |                                       |   |     |   |                            |   |     |   |                            |   |     |
|      |                                       | $C_R$                             | 如第5項進行試驗，沒有不合格<br>Per Item 5.  |      |                                       |   |     |   |                            |   |     |   |                            |   |     |
|      |                                       | $\tan \delta$                     | 如第6項進行試驗，沒有不合格<br>Per Item 6.  |      |                                       |   |     |   |                            |   |     |   |                            |   |     |
| 14   | 溫度特性<br>Temperature characteristics   | 見規格表規定<br>See specification sheet | <p>將電容器導線焊穩和調整振動頻率範圍為10-55Hz、總振幅為1.5mm，振動從10Hz到55Hz，然後再回到10Hz，大約一分鐘。</p> <p>The capacitor should be firmly soldered to the supporting lead wire and vibrated at a frequency range of 10 to 55Hz, 1.5mm in total amplitude, with about a 1 minute rate of vibration change from 10Hz to 55Hz and back to 10Hz.</p> <p>總時間六個小時，每兩小時在相互垂直方向來回三次。<br/>Apply for a total of 6 hours, 2 hours each in 3 mutually perpendicular directions.</p> <p>電容器必須按照下列每一步驟進行測量。<br/>The capacitance measurement should be made at each step specified in below.</p> <table border="1"> <tr> <td>Stwp</td> <td>Temperature (<math>\pm 1^\circ\text{C}</math>)</td> </tr> <tr> <td>1</td> <td>+20</td> </tr> <tr> <td>2</td> <td>Lower category temperature</td> </tr> <tr> <td>3</td> <td>+20</td> </tr> <tr> <td>4</td> <td>Upper category temperature</td> </tr> <tr> <td>5</td> <td>+20</td> </tr> </table> | Stwp | Temperature ( $\pm 1^\circ\text{C}$ ) | 1 | +20 | 2 | Lower category temperature | 3 | +20 | 4 | Upper category temperature | 5 | +20 |
| Stwp | Temperature ( $\pm 1^\circ\text{C}$ ) |                                   |  |      |                                       |   |     |   |                            |   |     |   |                            |   |     |
| 1    | +20                                   |                                   |  |      |                                       |   |     |   |                            |   |     |   |                            |   |     |
| 2    | Lower category temperature            |                                   |  |      |                                       |   |     |   |                            |   |     |   |                            |   |     |
| 3    | +20                                   |                                   |  |      |                                       |   |     |   |                            |   |     |   |                            |   |     |
| 4    | Upper category temperature            |                                   |  |      |                                       |   |     |   |                            |   |     |   |                            |   |     |
| 5    | +20                                   |                                   |  |      |                                       |   |     |   |                            |   |     |   |                            |   |     |
| 15   | 耐濕負荷<br>Humidity Loading              | APP                               | 沒有可見損傷<br>No marked defect   |      |                                       |   |     |   |                            |   |     |   |                            |   |     |
|      |                                       | $\Delta C/C$                      | $\pm 30\%$   |      |                                       |   |     |   |                            |   |     |   |                            |   |     |
|      |                                       | $\tan \delta$                     | 小於初始標準的2倍<br>Less than 200% initial specified value.   |      |                                       |   |     |   |                            |   |     |   |                            |   |     |
|      |                                       | IR                                | 大於初始標準的25%<br>More than 25% initial specified value.   |      |                                       |   |     |   |                            |   |     |   |                            |   |     |
|      |                                       | TV                                | 如第8項進行試驗，沒有不合格<br>Per Item 8.  |      |                                       |   |     |   |                            |   |     |   |                            |   |     |
| 16   | 高溫負荷<br>High Temperature Load         | APP                               | 沒有可見損傷<br>No marked defect   |      |                                       |   |     |   |                            |   |     |   |                            |   |     |
|      |                                       | $\Delta C/C$                      | $\pm 30\%$   |      |                                       |   |     |   |                            |   |     |   |                            |   |     |
|      |                                       | $\tan \delta$                     | 小於初始標準的2倍<br>Less than 200% of initial specified value.  |      |                                       |   |     |   |                            |   |     |   |                            |   |     |
|      |                                       | IR                                | 大於初始標準的50%<br>More than 50% initial specified value.   |      |                                       |   |     |   |                            |   |     |   |                            |   |     |
|      |                                       | TV                                | 如第8項進行試驗，沒有不合格<br>Per Item 8.  |      |                                       |   |     |   |                            |   |     |   |                            |   |     |

## 瓷片電容器規格承認書

### APPROVAL SPECIFICATION FOR DISC CERAMIC CAPACITORS

續上表  
Continued on the table

| No.   | 項目<br>Item  | 標準<br>Specifications       | 試驗方法<br>Testing Method   |                            |   |   |             |                            |                            |      |       |       |
|-------|---|----------------------------|--|----------------------------|---|---|-------------|----------------------------|----------------------------|------|-------|-------|
| 17    | APP   | 沒有可見損傷<br>No marked defect | 溫度循環試驗按以下條件進行試驗和測量<br>Temperature cycling shall be measured in the following test. <table style="width: 100%; border-collapse: collapse;"> <tr> <td style="text-align: center;">Step</td> <td style="text-align: center;">1</td> <td style="text-align: center;">2</td> </tr> <tr> <td style="text-align: center;">Temperature</td> <td style="text-align: center;">Lower category temperature</td> <td style="text-align: center;">Upper category temperature</td> </tr> <tr> <td style="text-align: center;">Time</td> <td style="text-align: center;">30min</td> <td style="text-align: center;">30min</td> </tr> </table> 循環次數: 5次<br>Cycle numbers: 5 cycles<br>試驗後處理: 電容器應在室溫下儲存24小時。<br>Post-treatment: Capacitor shall be stored for 24 h at room condition. | Step                       | 1 | 2 | Temperature | Lower category temperature | Upper category temperature | Time | 30min | 30min |
|       | Step  | 1                          |  | 2                          |   |   |             |                            |                            |      |       |       |
|       | Temperature   | Lower category temperature |  | Upper category temperature |   |   |             |                            |                            |      |       |       |
|       | Time  | 30min                      |  | 30min                      |   |   |             |                            |                            |      |       |       |
|       | ΔC/C  | ±20%                       |  |                            |   |   |             |                            |                            |      |       |       |
| tan δ | 小於初始標準的2倍<br>Less than 200% of initial specified value. |                            |  |                            |   |   |             |                            |                            |      |       |       |
| IR    | 大於初始標準的50%<br>More than 50% initial specified value.    |                            |  |                            |   |   |             |                            |                            |      |       |       |
| TV    | 如第8項進行試驗, 沒有不合格<br>Per Item 8.                          |                            |  |                            |   |   |             |                            |                            |      |       |       |

## 7. 包裝和儲存

### PACKAGING AND STORAGE

#### 7.2. 包裝

##### PACKAGING

盒裝編帶品, 每盒2000pcs (每箱20 000pcs)。

Taping of ammo packing, 2000 pcs/box (20 000 pcs/carton)

散包包裝, 每包1000pcs (視瓷片大小不等, 每箱20 000~100 000pcs)。

Bulk packing, 1000 pcs/bag (Depending on the disc size, each carton is 20 000~100 000pcs)

#### 7.2. 貯存條件

##### STORAGE ENVIRONMENT

電容器絕緣包封層不是完美的密封形式, 因此, 請勿將電容器存放在腐蝕性氣體中, 尤其是存在氯氣、硫氣、酸、堿、鹽等場所, 同時應防潮。

The insulating coating of capacitors does not form a perfect seal; therefore, do not use or store capacitors in a corrosive atmosphere, especially where chloride gas, sulfide gas, acid, alkali, salt or the like are present. And avoid exposure to moisture.

電容器應存放在溫度及相對濕度分別不超出5~40°C及15~70%範圍的場所。

Store the capacitors where the temperature and relative humidity do not exceed 5 to 40 degrees centigrade and 15 to 70%.

請在6個月內使用電容器。超過6個月, 在使用前確認其可焊性和電容量。

Use capacitors within 6 months after delivered. for more than 6 months, confirm the solderability and capacitance before use.



## 瓷片電容器規格承認書

### APPROVAL SPECIFICATION FOR DISC CERAMIC CAPACITORS

#### 8. 測量和使用注意事項

##### MEASURING AND APPLICATION NOTICE

##### 8.1. 測量注意事項

Measurement notice

請在以下條件下測量。

Please measure under the following conditions.

##### 8.1.1. 標準大氣條件

Standard atmospheric conditions

除非另有規定，所有試驗和測量應按在IEC 60068-1的5.3中規定的試驗用標準大氣條件下表進行。

Unless otherwise specified, all tests and measurements shall be made under standard atmospheric conditions for testing as given in 5.3 of IEC 60068-1.

| 溫度<br>Temperature | 相對濕度<br>Relative humidity | 氣壓<br>Air pressure |
|-------------------|---------------------------|--------------------|
| 15°C~35°C         | 25%~75%                   | 86kPa~106kPa       |

在進行測量之前，電容器應在測量溫度下存放足夠時間，以使整個電容器都達到這一溫度。為此目的，規定與試驗後恢復時間同樣的時間，通常是足夠的。

Before the measurements are made, the capacitor shall be stored at the measuring temperature for a time sufficient to allow the entire capacitor to reach this temperature. The period as prescribed for recovery at the end of a test is normally sufficient for this purpose.

在標準大氣條件下進行測量，其測量結果存在爭議時應採用仲裁溫度（見8.1.3）重復測量。

Test and measurement shall be made under standard atmospheric conditions for testing, in the event of a dispute, the measurements shall be repeated using one of the referee temperatures (as given in 8.1.3).

當按某一順序進行試驗時，一個試驗的最後測量可以作為下一試驗的初始測量。

When tests are conducted in a sequence, the final measurements of one test may be taken as the initial measurements for the succeeding test.

在測量期間，不應使電容器受到氣流、陽光直射或可能引起誤差的其他影響。

During measurements the capacitor shall not be exposed to draughts, direct sunlight or other influences likely to cause error.

##### 8.1.2. 恢復條件

Recovery conditions

除非另有規定，恢復應在試驗用標準大氣條件（見8.1.1）下進行。

Unless otherwise specified recovery shall take place under the standard atmospheric conditions for testing (8.1.1).

如果恢復必須在嚴格控制的條件下進行，應採用IEC 60068-1中5.4.1的控制條件。

If recovery under closely controlled conditions is necessary, the controlled recovery conditions of 5.4.1 of IEC 60068-1 shall be used.

除非有關規範另有規定，恢復時間應為1h~2h。

Unless otherwise specified in the relevant specification, a duration of 1 h to 2 h shall be used.

##### 8.1.3. 仲裁條件

Referee conditions

在仲裁情況下，應選用IEC 60068-1中5.2中規定的仲裁試驗用標準大氣條件。

For referee purposes, one of the standard atmospheric conditions for referee tests taken from 5.2 of IEC 60068-1, as given in table 1 below, shall be selected:

| 溫度<br>Temperature | 相對濕度<br>Relative humidity | 氣壓<br>Air pressure |
|-------------------|---------------------------|--------------------|
| 25°C±1°C          | 48%~52%                   | 86kPa~106kPa       |

##### 8.2. 工作電壓

Operating voltage

嚮電容器施加的電壓切勿超過額定電壓。

The voltage applied to the capacitor must not exceed the rated voltage.

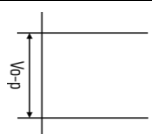
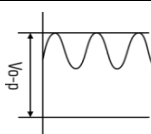
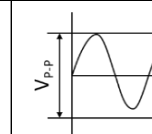
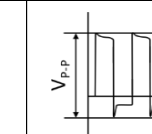
| 電壓<br>Voltage                     | 直流電壓<br>DC Voltage  | 直流+交流電壓<br>DC+AC Voltage  | 交流電壓<br>AC Voltage   | 脈沖電壓<br>Pulse Voltage   |
|-----------------------------------|---|---|--|---|
| 測量位置<br>Positional<br>Measurement |  |  |  |  |

## 瓷片電容器規格承認書

### APPROVAL SPECIFICATION FOR DISC CERAMIC CAPACITORS

在交流電路或紋波電流電路中使用直流額定電壓電容器時，請務必將外加電壓的Vp-p值或包含直流偏置電壓的Vo-p值維持在額定電壓範圍內。

When DC-rated capacitors are to be used in AC or ripple current circuits, be sure to maintain the Vp-p value of the applied voltage or the Vo-p which contains DC bias within the rated voltage range.

若電路施加電壓，開始或停止時可能會因諧振或切換產生暫時的異常電壓。請務必使用額定電壓範圍包含這些異常電壓的電容器。

When the voltage is applied to the circuit, starting or stopping may generate irregular voltage for a transit period because of resonance or switching. Be sure to use a capacitor with a rated voltage range that includes these irregular voltages.

#### 8.3. 過電壓影響

##### Overvoltage effects

施加到電容器的過電壓可能會導致電容器內部介質層擊穿而引起電路短路。

The overvoltage applied to the capacitor may cause the dielectric layer of the capacitor to break down and cause a short circuit.

擊穿前的可持續時間取決於施加電壓和周圍溫度。

The duration before the breakdown depends on the applied voltage and the ambient temperature.

#### 8.4. 焊錫

##### Soldering

當在PCB/PWB焊錫這個產品時，不要超過電容器的焊錫耐熱性標準。過度的熱量會使電容器內部焊錫熔化，可能導致熱沖擊而使陶瓷介質出現暗裂。

When soldering this product to a PCB/PWB, do not exceed the solder heat resistance specifications of the capacitor. Subjecting this product to excessive heating could melt the internal junction solder and may result in thermal shocks that can crack the ceramic element.



注意：請不要使用於雙波峰焊錫中，如果需要使用於雙波峰焊錫，請提前通知我公司。

Note: please do not use in double wave soldering. If you use double wave soldering, please inform our company in advance.

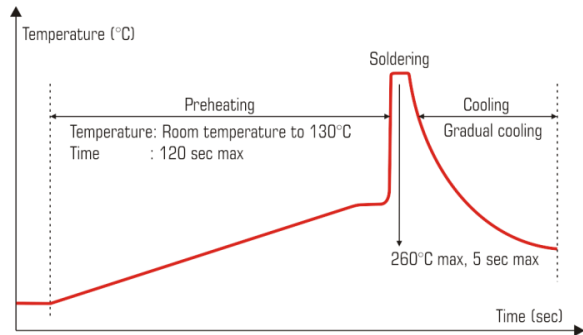

Fig.: Wave-soldering temperature-time profile to recommend

當使用烙鐵進行手工焊錫時，應該遵照下列條件：

When soldering capacitor with a soldering iron, it should be performed in the following conditions.

焊錫溫度：320°C最大

Temperature of iron-tip: 320 degrees C. Max.

烙鐵頭：不超過40W

Soldering iron wattage: 40W max.

焊錫時間：不超過3.0秒

Soldering time: 3.0 sec. Max.

## 瓷片電容器規格承認書

### APPROVAL SPECIFICATION FOR DISC CERAMIC CAPACITORS

#### 9. 編帶尺寸規格 TAPING SPECIFICATIONS

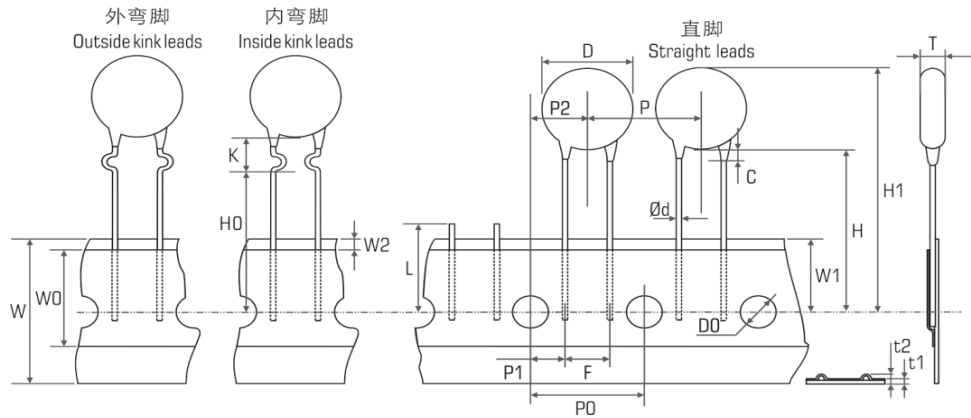

| 項目<br>Item  | 代碼<br>Symbol        | 標準<br>Specification<br>(mm) | 備註<br>Remarks  |
|---|---------------------|-----------------------------|--|
| 導線直徑<br>Lead-wire diameter                          | d                   | 0.50±0.10                   |  |
| 元件間距<br>Pitch of component                          | P                   | 12.7±1.0                    |  |
| 進料孔間距<br>Feed hole pitch                            | P0                  | 12.7±0.3                    | 間距累積誤差: 每20孔1.0mm<br>Cumulative pitch error:<br>1.0mm/20 pitch |
| 進料孔與導線垂直距離<br>Feed hole center to lead              | P1                  | 3.85±0.7                    |  |
| 進料孔與元件垂直距離<br>Hole center to component center       | P2                  | 6.35±1.3                    |  |
| 腳距<br>Lead-to-lead distance                         | F                   | 5.0±0.8                     |  |
| 元件偏移<br>Component alignment                         | Δh                  | ≤2.0                        |  |
| 元件沿編帶偏離, 左或右<br>Deviation along tape, Left or right | ΔS                  | ≤1.3                        |  |
| 紙帶寬<br>Tape width                                   | W                   | 18.0+1.0/-0.5               |  |
| 膠帶寬<br>Hold-down tape width                         | W0                  | ≥7.0                        |  |
| 孔位<br>Hole position                                 | W1                  | 9.0+0.75/-0.5               |  |
| 膠帶位置<br>Hole-down tape position                     | W2                  | ≤3.0                        |  |
| 元件到紙帶的高度<br>Height of component from tape center    | 直腳<br>Straight lead | H                           | 18.0+2/-0  |
|   | 彎腳<br>Kinked lead   | H0                          | 16.0±0.5   |
| 元件高度<br>Component height                            | H1                  | ≤32.25                      |  |
| 進料孔直徑<br>Feed hole diameter                         | D0                  | 4.0±0.3                     |  |
| 編帶厚度<br>Total tape thickness                        | t1                  | ≤0.9                        | 紙帶厚度: 0.5±0.1mm<br>Ground paper: 0.5±0.1mm                     |
| 編帶厚度 (含導線)<br>Total thickness, tape and lead wire   | t2                  | ≤1.5                        |  |
| 剪切長度<br>Length of snapped                           | L                   | ≤11.0                       |  |