

MMBT2907A

Features

- ◆ PNP Silicon Epitaxial Planar Transistor
- ◆ For Switching and Amplifier Applications.
- ◆ The transistor is subdivided into one group according to its DC current gain

SOT-23
(TO-236)

Marking:2F

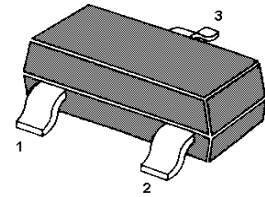

1 Base 2. Emitter 3. Collector

Absolute Maximum Ratings (T_A=25°C, unless otherwise noted)

Parameter	Symbol	Value	Unit
Collector Base Voltage	-V _{CBO}	60	V
Collector Emitter Voltage	-V _{CEO}	60	V
Emitter Base Voltage	-V _{EBO}	5	V
Collector Current	-I _C	600	mA
Power Dissipation	P _{tot}	350	mW
Junction Temperature	T _J	150	°C
Storage Temperature Range	T _{STG}	-55 to 150	°C

Electrical Characteristics (T_A=25 °C, unless otherwise noted)

Parameter	Symbol	Min.	Max.	Unit
DC Current Gain at -V _{CE} =10V, -I _C =0.1mA at -V _{CE} =10V, -I _C =1 mA at -V _{CE} =10V,-I _C =10mA at -V _{CE} =10V, -I _C =150 mA at -V _{CE} =10V,-I _C =500mA	H _{FE}	75 100 100 100 50	- - - 300 -	- - - - -
Collector Base Cutoff Current at -V _{CB} =50 V	-I _{CBO}	-	10	nA
Collector Base Breakdown Voltage at -I _C =10uA	-V _{(BR)CBO}	60	-	V
Collector Emitter Breakdown Voltage at -I _C =10mA	-V _{(BR)CEO}	60	-	V
Emitter Base Breakdown Voltage at -I _E =10uA	-V _{(BR)EBO}	5	-	V
Collector Emitter Saturation Voltage at -I _C =150 mA, -I _B = 15 mA at -I _C =500mA, -I _B =50mA	-V _{CE(sat)}	- -	0.4 1.6	V
Base Saturation Voltage at -I _C = 150mA, -I _B = 15mA at -I _C = 500mA, -I _B = 50mA	-V _{BE(sat)}	- -	1.3 2.6	V
Transition Frequency at -V _{CE} = 20 V, -I _C = 50mA, f=100MHz	F _T	200	-	MHz
Collector Base Capacitance at -V _{CB} =10V,f=1MHz	C _{OB}	-	8	PF
Turn-on Time at -V _{CC} =30V,-I _C =150mA,-I _{B1} =15mA	t _{on}	-	45	ns
Delay Time at -V _{CC} =30V,-I _C =150mA,-I _{B1} =15mA	t _d	-	10	ns
Rise Time at -V _{CC} =30V,-I _C =150mA,-I _{B1} =15mA	t _r	-	40	ns
Turn-off Time at -V _{CC} =6V,-I _C =150mA,-I _{B1} =-I _{B2} =15mA	t _{off}	-	100	ns
Storage Time at -V _{CC} =6V,-I _C =150mA,-I _{B1} =-I _{B2} =15mA	t _s	-	80	ns
Fall Time at -V _{CC} =6V,-I _C =150mA,-I _{B1} =-I _{B2} =15mA	t _f	-	30	ns

Typical Characteristics Curves

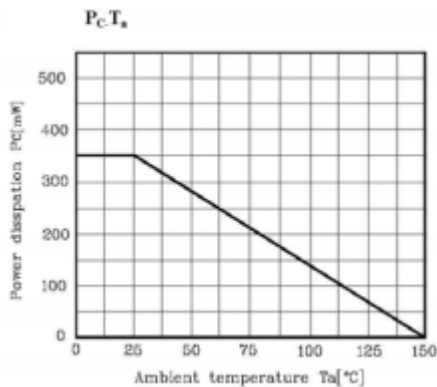
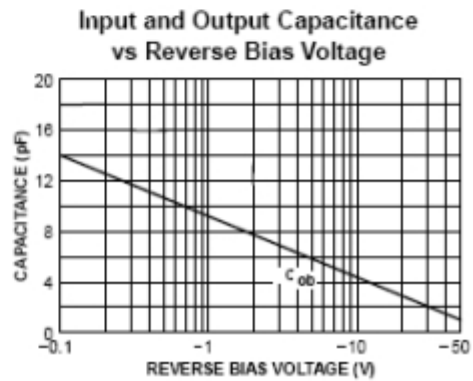
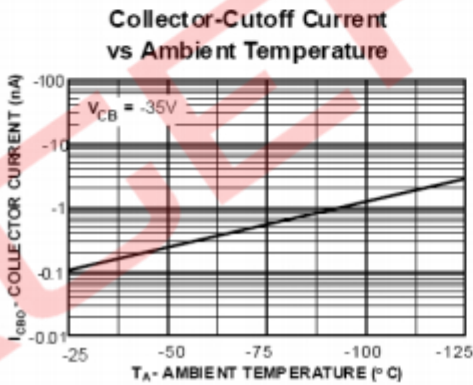
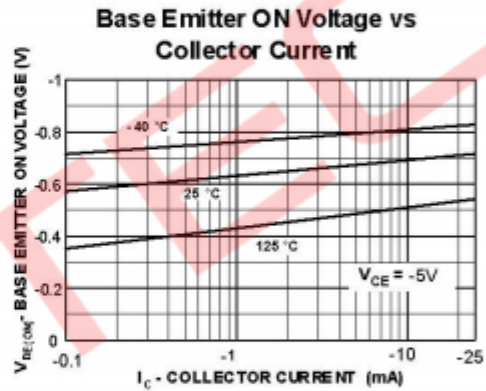
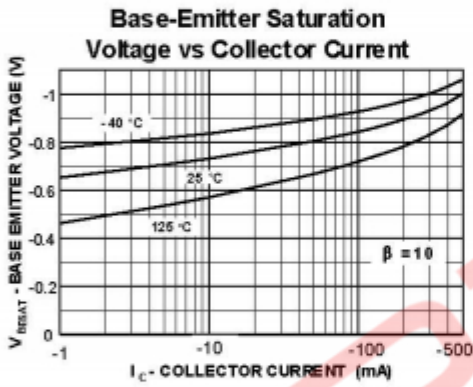
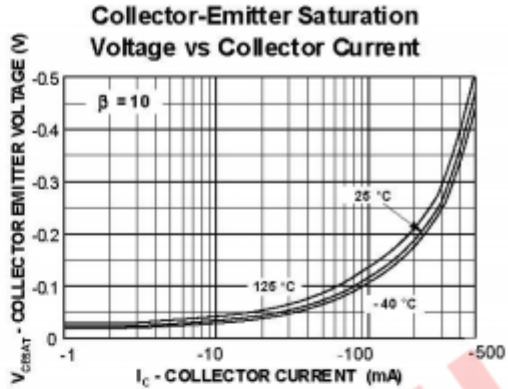
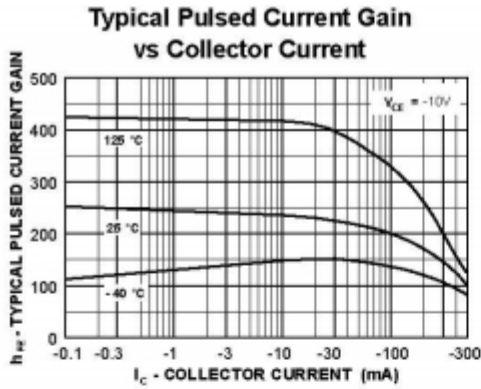

MMBT2907A

Package Outline

SOT-23 (TO-236)

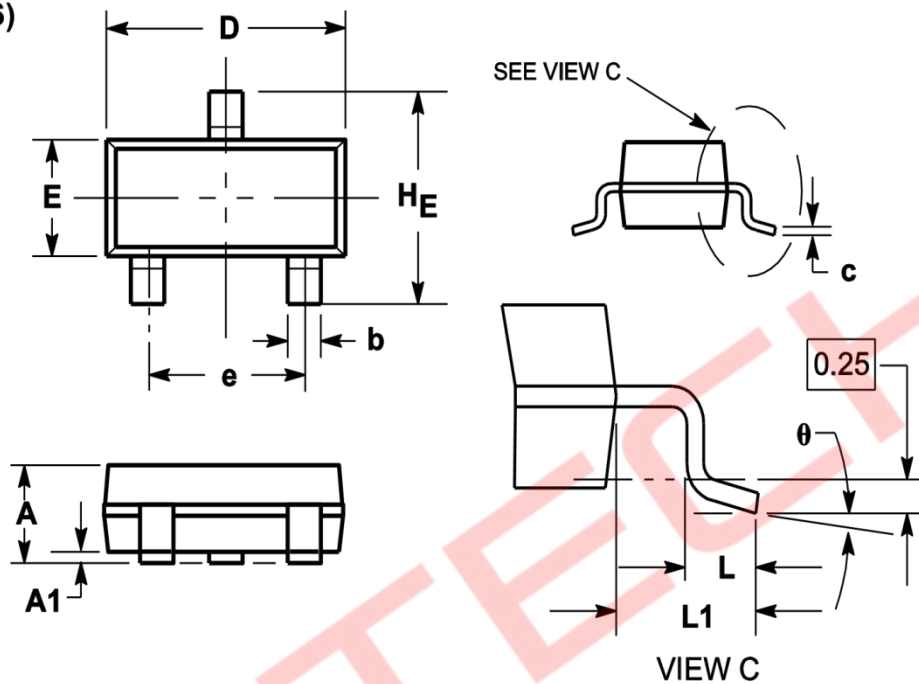

Symbol	Dimensions in millimeter		
	Min.	Typ.	Max.
A	0.900	1.025	1.150
A1	0.000	0.050	0.100
b	0.300	0.400	0.500
c	0.080	0.115	0.150
D	2.800	2.900	3.000
E	1.200	1.300	1.400
HE	2.250	2.400	2.550
e	1.800	1.900	2.000
L1	0.550REF		
L	0.300		0.500
θ	0°		8°

Device	Package	Reel Dimension (inch)	Shipping
MMBT2907A	SOT-23	7	3,000