

# NanoT Series

## The Most Compact Nano Size Tact Switch

### Features

- Ultra Compact Size
- SMT or PIP versions
- IP67
- Integrated Actuator
- High life cycles

### Typical Applications

- Hearing Aids
- Headsets
- Sports watch
- IoT portable device

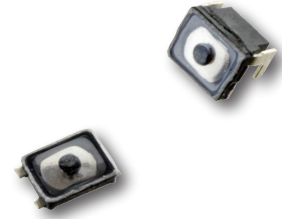

Part Number	Style	Force (gf)	Life (Cycles)
NanoT 100 AS	Top Actuated with SMT termination	100 +40/-30	200,000
NanoT 160 AS	Top Actuated with SMT termination	160 +/- 50	300,000
NanoT 240 AS	Top Actuated with SMT termination	240 +/- 60	200,000
NanoT 160 BP	Side actuated with PIP* termination	160 +/- 50	300,000
NanoT 240 BP	Side actuated with PIP* termination	240 +/- 60	200,000

\*PIP: Pin in Paste also called Pin Through Paste

### Specifications

TRAVEL: 0.1 mm +/- 0.05 mm  
 OPERATING TEMPERATURE: -40 ~ +85°C  
 OPERATING TEMPERATURE: -40 ~ +85°C  
 RATING: 15V D.C. / 20mA  
 INSULATION RESISTANCE: 100 MΩ Min.  
 WITHSTAND VOLTAGE: 250V A.C. (50~60Hz 2mA) for 1 min.  
 BOUNCE: ON/OFF 10 ms Max.  
 CONTACT RESISTANCE: 500mΩ Max.

### Packaging

In reels of 7,500 pieces for the Side actuated  
 In reels of 8,000 pieces for the Top actuated  
 Dimensions of reels according to EIA RS481 or IEC 2863. External diameter 330 mm ± 2 mm.

### How To Order

Our easy build-a-switch concept allows you to mix and match options to create the switch you need. To order, select desired option from each category and place it in the appropriate box.

**For any part number different from those listed above, please consult your local representative.**

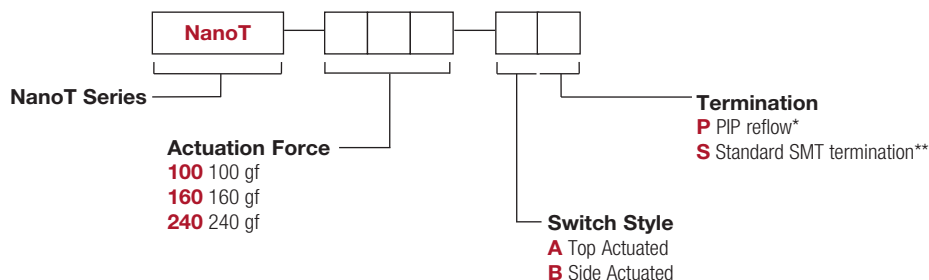

\* P termination for side version only

\*\* S termination for top version only

# NanoT Series

## The Most Compact Nano Size Tact Switch

### TOP ACTUATED

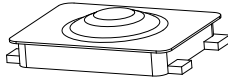
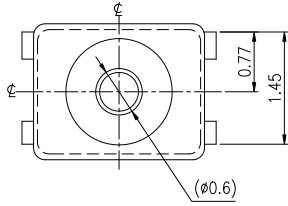

SCHEMATIC

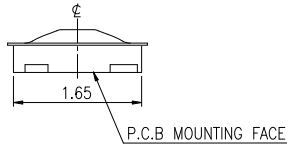
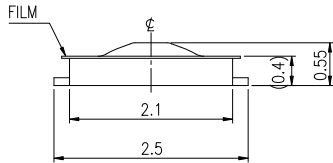
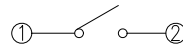

P.C.B LAYOUT

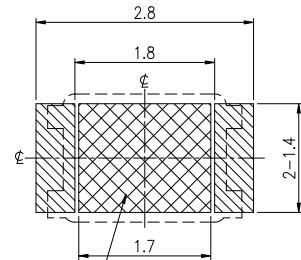

Any land pattern or vias should be prevented at area.

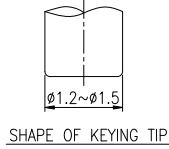
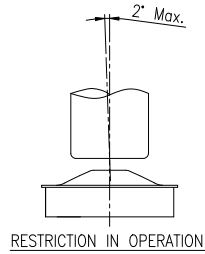
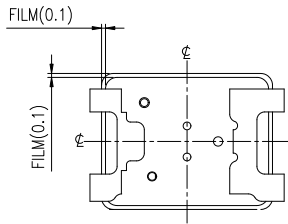

### SIDE ACTUATED PIP

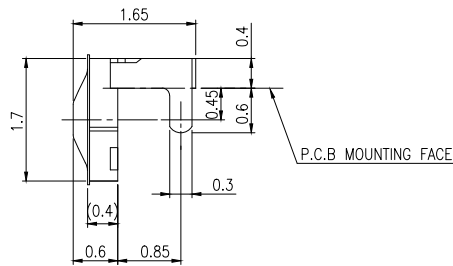
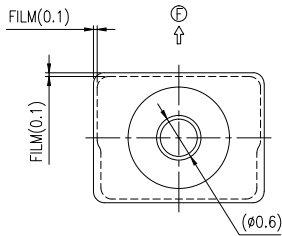
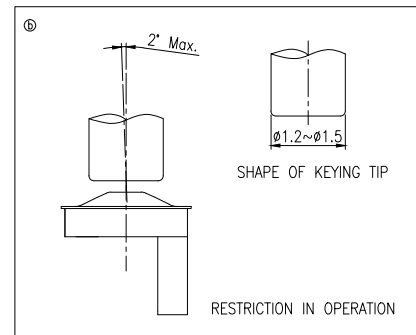
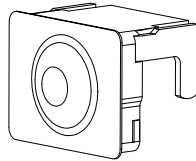
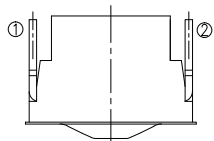

P.C.B MOUNTING FACE

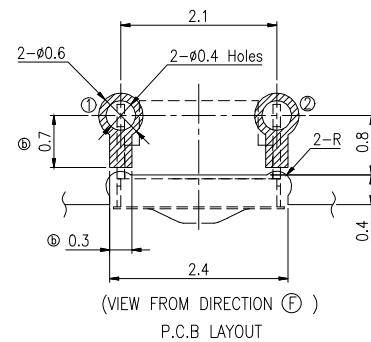
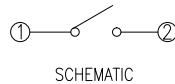

(VIEW FROM DIRECTION ①)  
P.C.B LAYOUT