

Low Noise Dual/Quad Operational Amplifiers

The HT33078/9 series is a family of high quality monolithic amplifiers employing Bipolar technology with innovative high performance concepts for quality audio and data signal processing applications. This family incorporates the use of high frequency PNP input transistors to produce amplifiers exhibiting low input voltage noise with high gain bandwidth product and slew rate. The all NPN output stage exhibits no deadband crossover distortion, large output voltage swing, excellent phase and gain margins, low open loop high frequency output impedance and symmetrical source and sink AC frequency performance.

The HT33078/9 family offers both dual and quad amplifier versions and is available in the plastic DIP and SOIC packages (P and D suffixes).

Features

- Dual Supply Operation: $\pm 5.0\text{ V}$ to $\pm 18\text{ V}$
- Low Voltage Noise: $4.5\text{ nV}/\sqrt{\text{Hz}}$
- Low Input Offset Voltage: 0.15 mV
- Low T.C. of Input Offset Voltage: $2.0\text{ }\mu\text{V}/^\circ\text{C}$
- Low Total Harmonic Distortion: 0.002%
- High Gain Bandwidth Product: 16 MHz
- High Slew Rate: $7.0\text{ V}/\mu\text{s}$
- High Open Loop AC Gain: $800 @ 20\text{ kHz}$
- Excellent Frequency Stability
- Large Output Voltage Swing: $+14.1\text{ V}/-14.6\text{ V}$
- ESD Diodes Provided on the Inputs
- NCV Prefix for Automotive and Other Applications Requiring Unique Site and Control Change Requirements
- These Devices are Pb-Free, Halogen Free/BFR Free and are RoHS Compliant

DUAL

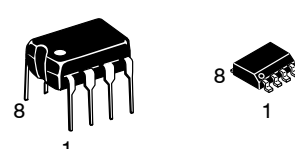

QUAD

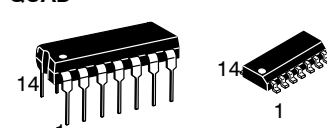

ORDERING INFORMATION

HT33078ANZ	DIP8
HT33078ARZ	SOP8
HT33079ANZ	DIP14
HT33079ARZ	SOP14

$T_A = -40^\circ$ to 85°C for all packages.

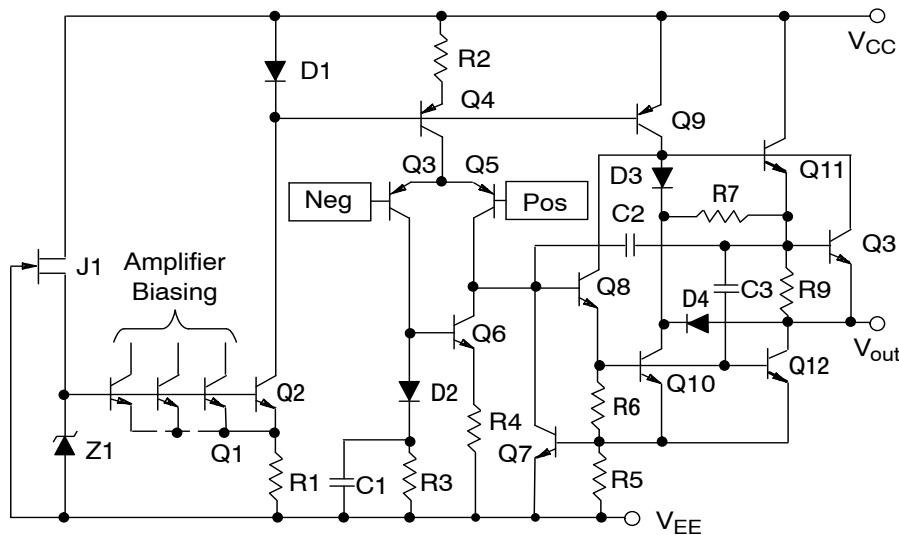
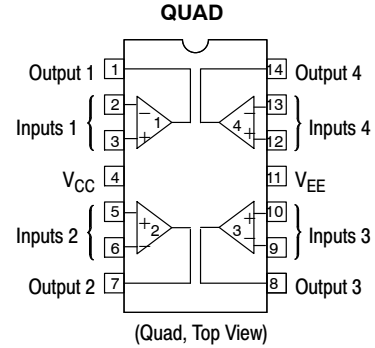
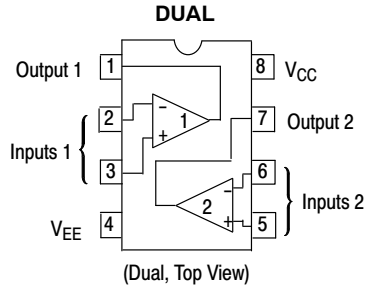

Figure 1. Representative Schematic Diagram
(Each Amplifier)

PIN CONNECTIONS

MAXIMUM RATINGS

Rating	Symbol	Value	Unit
Supply Voltage (V_{CC} to V_{EE})	V_S	+36	V
Input Differential Voltage Range	V_{IDR}	Note 1	V
Input Voltage Range	V_{IR}	Note 1	V
Output Short Circuit Duration (Note 2)	t_{SC}	Indefinite	sec
Maximum Junction Temperature	T_J	+150	°C
Storage Temperature	T_{stg}	-60 to +150	°C
ESD Protection at any Pin HT33078 HT33079	V_{esd}	600 550	V
Maximum Power Dissipation	P_D	Note 2	mW
Operating Temperature Range	T_A	-40 to +85	°C

Stresses exceeding Maximum Ratings may damage the device. Maximum Ratings are stress ratings only. Functional operation above the Recommended Operating Conditions is not implied. Extended exposure to stresses above the Recommended Operating Conditions may affect device reliability.

1. Either or both input voltages must not exceed the magnitude of V_{CC} or V_{EE} .
2. Power dissipation must be considered to ensure maximum junction temperature (T_J) is not exceeded (see Figure 2).

DC ELECTRICAL CHARACTERISTICS ($V_{CC} = +15\text{ V}$, $V_{EE} = -15\text{ V}$, $T_A = 25^\circ\text{C}$, unless otherwise noted.)

Characteristics	Symbol	Min	Typ	Max	Unit
Input Offset Voltage ($R_S = 10\ \Omega$, $V_{CM} = 0\text{ V}$, $V_O = 0\text{ V}$) (HT33078) $T_A = +25^\circ\text{C}$ $T_A = -40^\circ$ to $+85^\circ\text{C}$ (HT33079) $T_A = +25^\circ\text{C}$ $T_A = -40^\circ$ to $+85^\circ\text{C}$	$ V_{IO} $	-	0.15	2.0	mV
Average Temperature Coefficient of Input Offset Voltage $R_S = 10\ \Omega$, $V_{CM} = 0\text{ V}$, $V_O = 0\text{ V}$, $T_A = T_{low}$ to T_{high}	$\Delta V_{IO}/\Delta T$	-	2.0	-	$\mu\text{V}/^\circ\text{C}$
Input Bias Current ($V_{CM} = 0\text{ V}$, $V_O = 0\text{ V}$) $T_A = +25^\circ\text{C}$ $T_A = -40^\circ$ to $+85^\circ\text{C}$	I_{IB}	-	300	750	nA
Input Offset Current ($V_{CM} = 0\text{ V}$, $V_O = 0\text{ V}$) $T_A = +25^\circ\text{C}$ $T_A = -40^\circ$ to $+85^\circ\text{C}$	I_{IO}	-	25	150	nA
Common Mode Input Voltage Range ($\Delta V_{IO} = 5.0\text{ mV}$, $V_O = 0\text{ V}$)	V_{ICR}	± 13	± 14	-	V
Large Signal Voltage Gain ($V_O = \pm 10\text{ V}$, $R_L = 2.0\text{ k}\Omega$) $T_A = +25^\circ\text{C}$ $T_A = -40^\circ$ to $+85^\circ\text{C}$	A_{VOL}	90	110	-	dB
Output Voltage Swing ($V_{ID} = \pm 1.0\text{ V}$) $R_L = 600\ \Omega$ $R_L = 600\ \Omega$ $R_L = 2.0\text{ k}\Omega$ $R_L = 2.0\text{ k}\Omega$ $R_L = 10\text{ k}\Omega$ $R_L = 10\text{ k}\Omega$	V_{O+} V_{O-} V_{O+} V_{O-} V_{O+} V_{O-}	-	+10.7	-	V
Common Mode Rejection ($V_{in} = \pm 13\text{ V}$)	CMR	80	100	-	dB
Power Supply Rejection (Note 3) $V_{CC}/V_{EE} = +15\text{ V}/-15\text{ V}$ to $+5.0\text{ V}/-5.0\text{ V}$	PSR	80	105	-	dB
Output Short Circuit Current ($V_{ID} = 1.0\text{ V}$, Output to Ground) Source Sink	I_{SC}	+15	+29	-	mA
Power Supply Current ($V_O = 0\text{ V}$, All Amplifiers) (HT33078) $T_A = +25^\circ\text{C}$ $T_A = -40^\circ$ to $+85^\circ\text{C}$ (HT33079) $T_A = +25^\circ\text{C}$ $T_A = -40^\circ$ to $+85^\circ\text{C}$	I_D	-	4.1	5.0	mA

 3. Measured with V_{CC} and V_{EE} differentially varied simultaneously.

AC ELECTRICAL CHARACTERISTICS ($V_{CC} = +15\text{ V}$, $V_{EE} = -15\text{ V}$, $T_A = 25^\circ\text{C}$, unless otherwise noted.)

Characteristics	Symbol	Min	Typ	Max	Unit
Slew Rate ($V_{in} = -10\text{ V}$ to $+10\text{ V}$, $R_L = 2.0\text{ k}\Omega$, $C_L = 100\text{ pF}$, $A_V = +1.0$)	SR	5.0	7.0	-	$\text{V}/\mu\text{s}$
Gain Bandwidth Product ($f = 100\text{ kHz}$)	GBW	10	16	-	MHz
Unity Gain Bandwidth (Open Loop)	BW	-	9.0	-	MHz
Gain Margin ($R_L = 2.0\text{ k}\Omega$) $C_L = 0\text{ pF}$ $C_L = 100\text{ pF}$	A_m	-	-11 -6.0	-	dB
Phase Margin ($R_L = 2.0\text{ k}\Omega$) $C_L = 0\text{ pF}$ $C_L = 100\text{ pF}$	ϕ_m	-	55 40	-	Deg
Channel Separation ($f = 20\text{ Hz}$ to 20 kHz)	CS	-	-120	-	dB
Power Bandwidth ($V_O = 27\text{ V}_{pp}$, $R_L = 2.0\text{ k}\Omega$, $\text{THD} \pm 1.0\%$)	BW_p	-	120	-	kHz
Total Harmonic Distortion ($R_L = 2.0\text{ k}\Omega$, $f = 20\text{ Hz}$ to 20 kHz , $V_O = 3.0\text{ V}_{rms}$, $A_V = +1.0$)	THD	-	0.002	-	%
Open Loop Output Impedance ($V_O = 0\text{ V}$, $f = 9.0\text{ MHz}$)	$ Z_O $	-	37	-	Ω
Differential Input Resistance ($V_{CM} = 0\text{ V}$)	R_{in}	-	175	-	$\text{k}\Omega$
Differential Input Capacitance ($V_{CM} = 0\text{ V}$)	C_{in}	-	12	-	pF
Equivalent Input Noise Voltage ($R_S = 100\ \Omega$, $f = 1.0\text{ kHz}$)	e_n	-	4.5	-	$\text{nV}/\sqrt{\text{Hz}}$
Equivalent Input Noise Current ($f = 1.0\text{ kHz}$)	i_n	-	0.5	-	$\text{Hz}\sqrt{\text{pA}}$

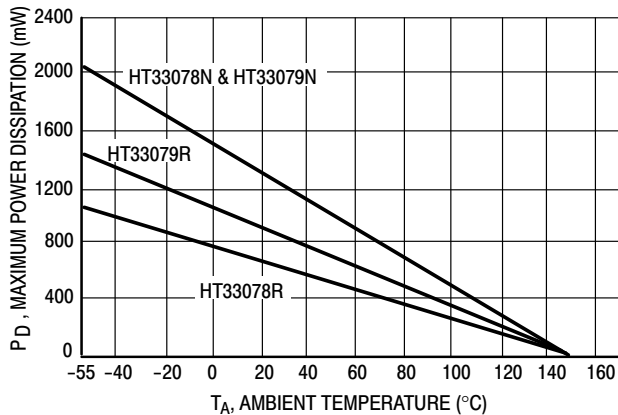
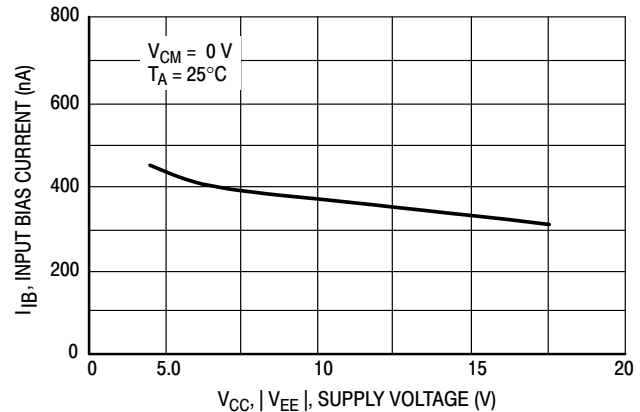
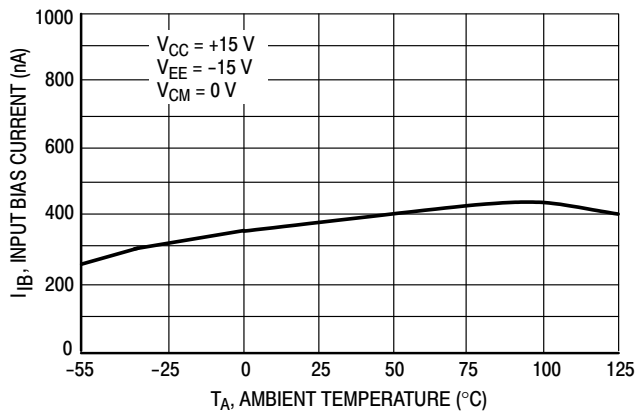
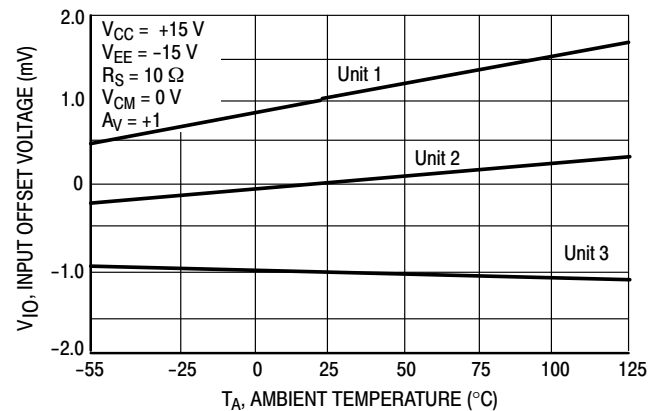
Figure 2. Maximum Power Dissipation versus Temperature

Figure 3. Input Bias Current versus Supply Voltage

Figure 4. Input Bias Current versus Temperature

Figure 5. Input Offset Voltage versus Temperature

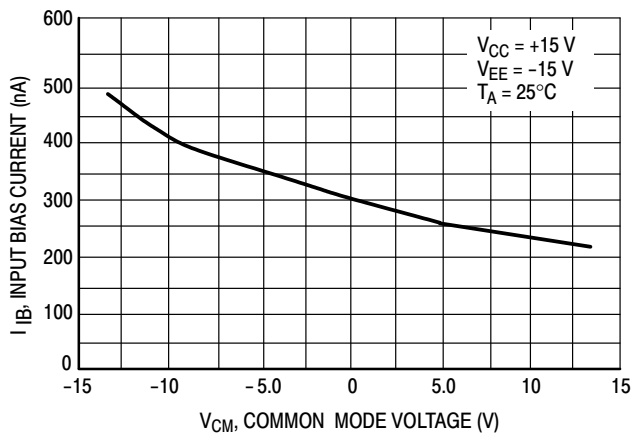

Figure 6. Input Bias Current versus Common Mode Voltage

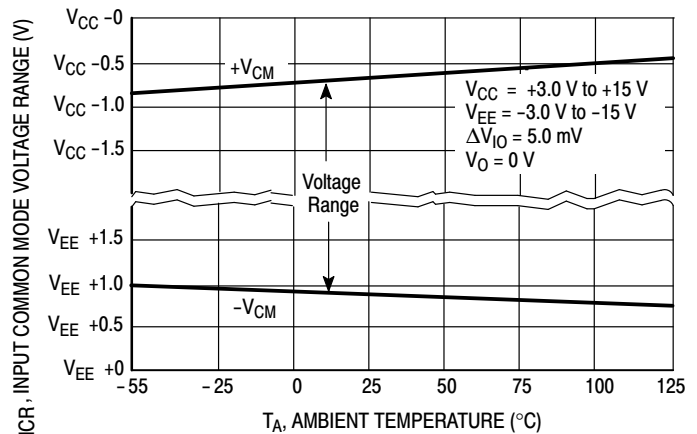

Figure 7. Input Common Mode Voltage Range versus Temperature

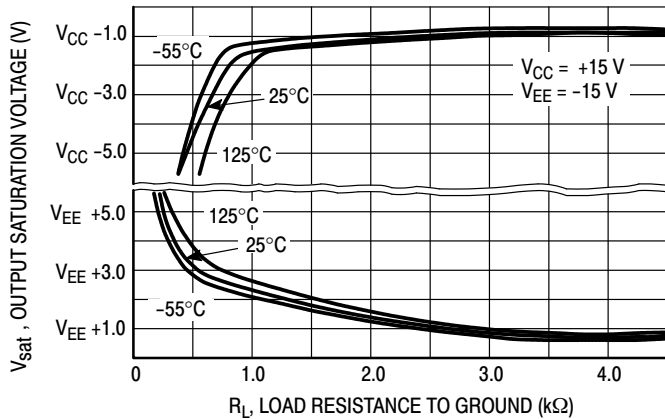

Figure 8. Output Saturation Voltage versus Load Resistance to Ground

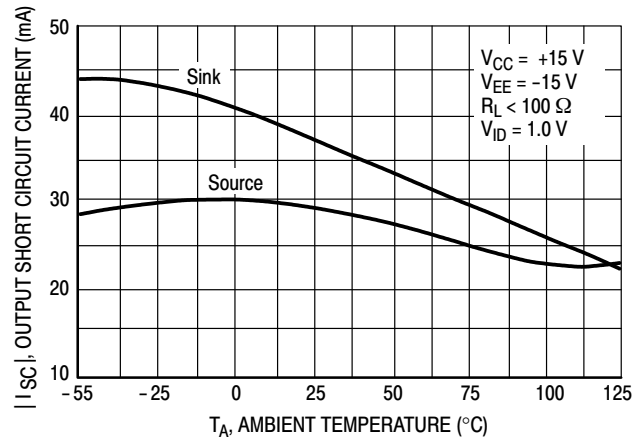

Figure 9. Output Short Circuit Current versus Temperature

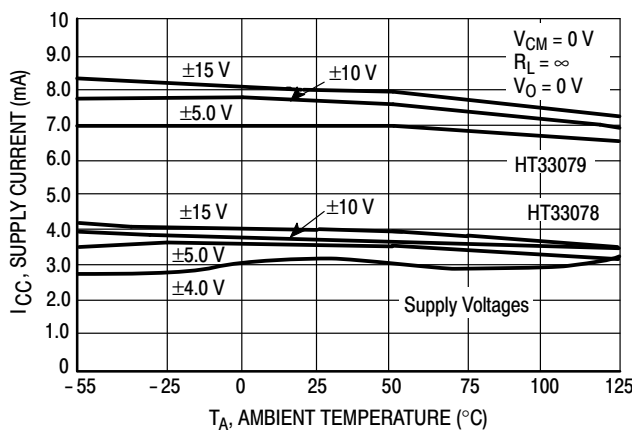

Figure 10. Supply Current versus Temperature

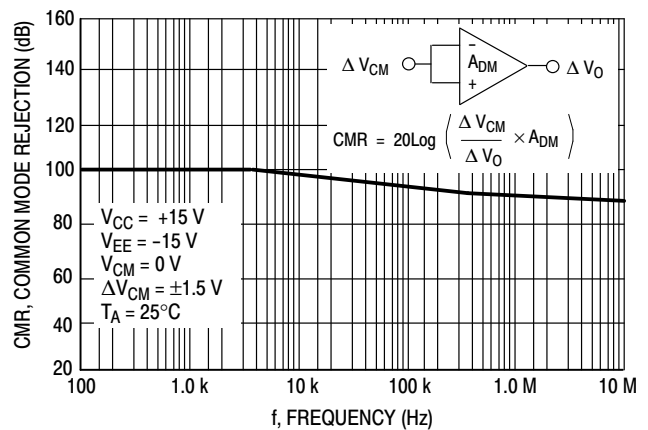

Figure 11. Common Mode Rejection versus Frequency

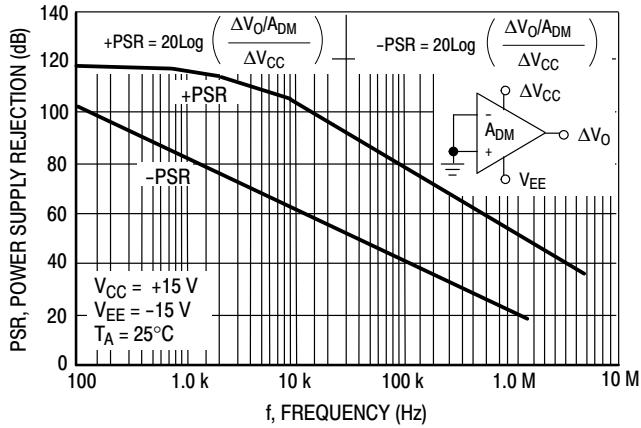

Figure 12. Power Supply Rejection versus Frequency

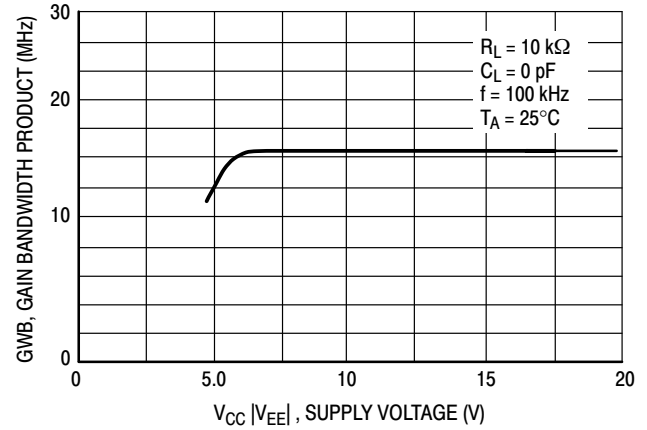

Figure 13. Gain Bandwidth Product versus Supply Voltage

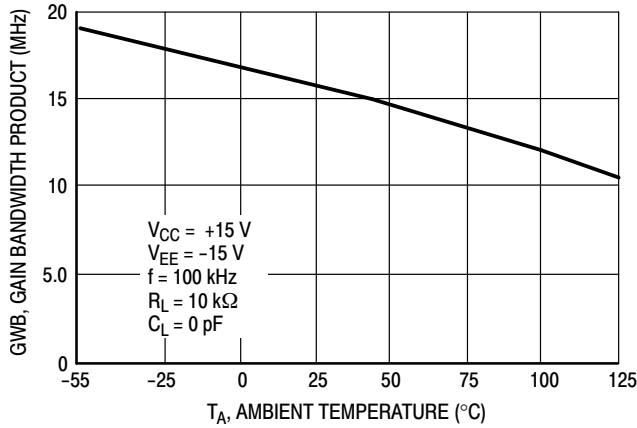

Figure 14. Gain Bandwidth Product versus Temperature

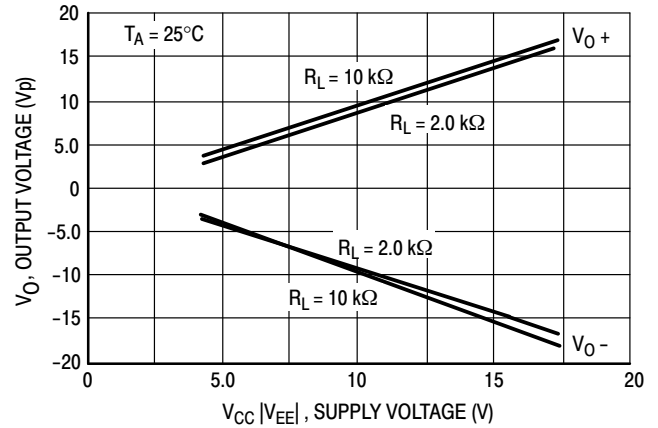

Figure 15. Maximum Output Voltage versus Supply Voltage

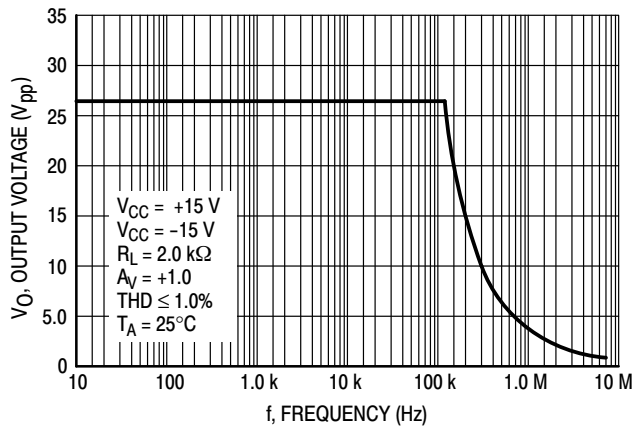

Figure 16. Output Voltage versus Frequency

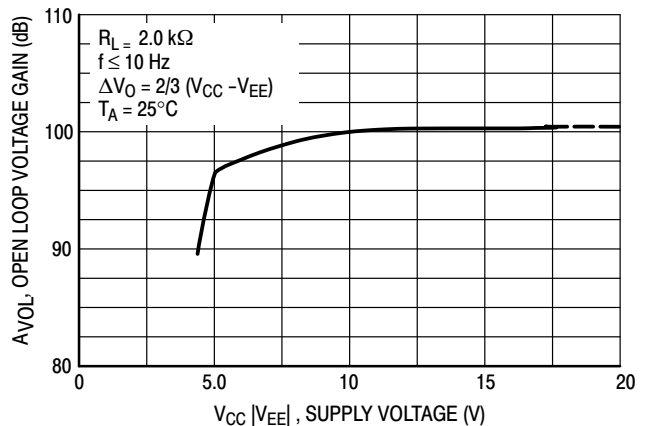

Figure 17. Open Loop Voltage Gain versus Supply Voltage

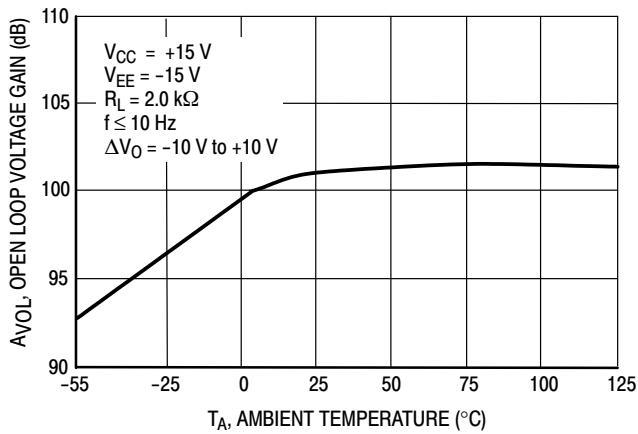

Figure 18. Open Loop Voltage Gain versus Temperature

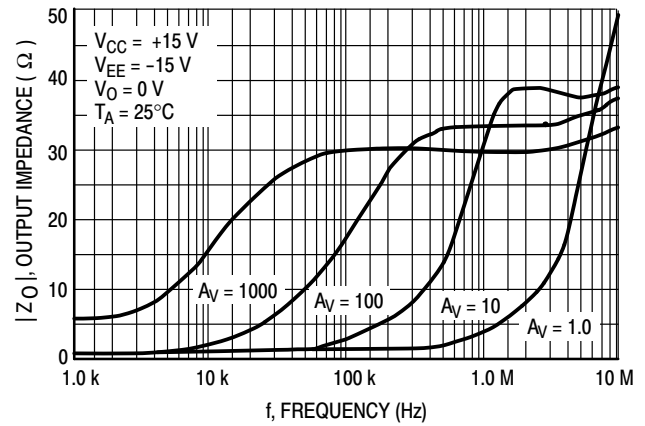

Figure 19. Output Impedance versus Frequency

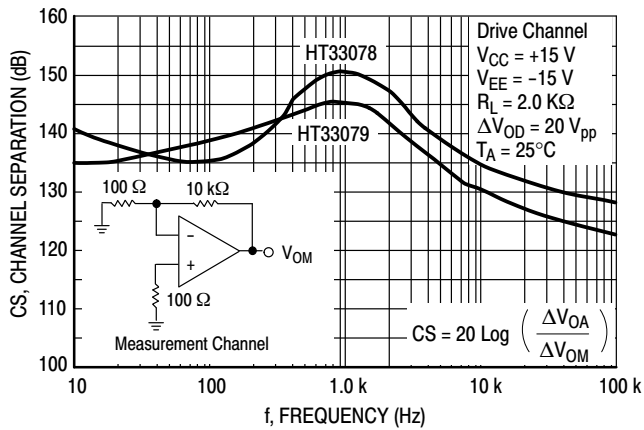

Figure 20. Channel Separation versus Frequency

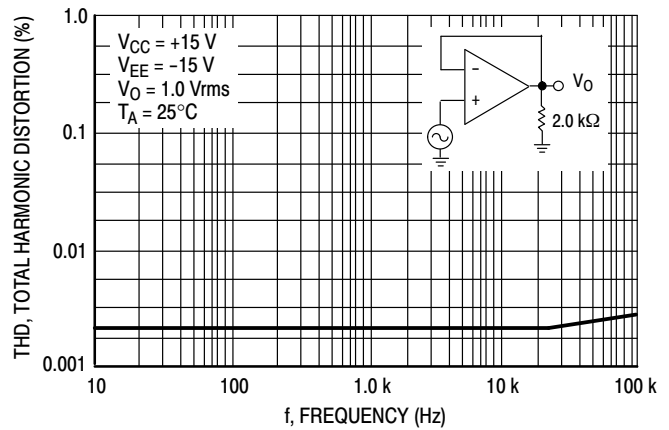

Figure 21. Total Harmonic Distortion versus Frequency

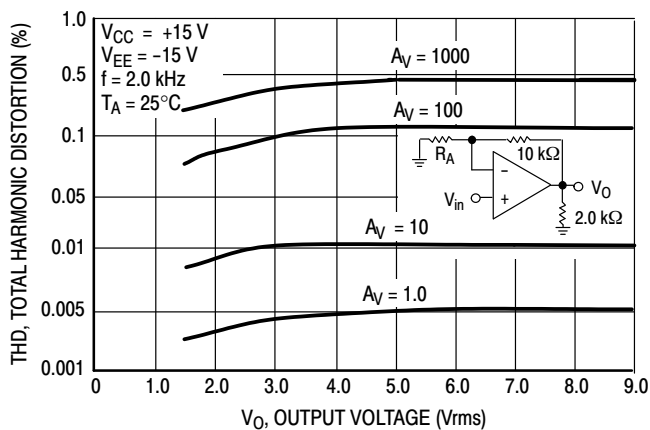

Figure 22. Total Harmonic Distortion versus Output Voltage

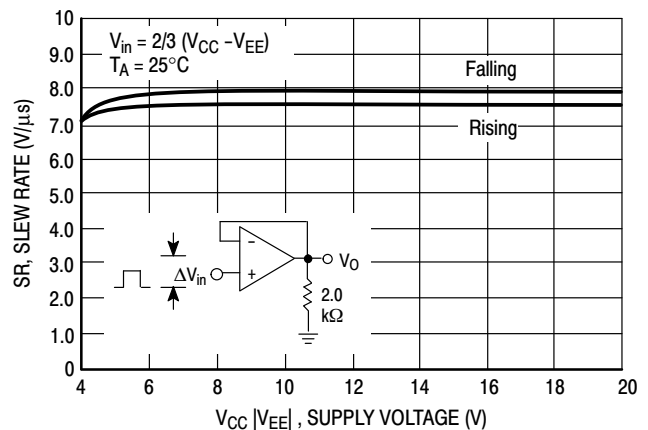
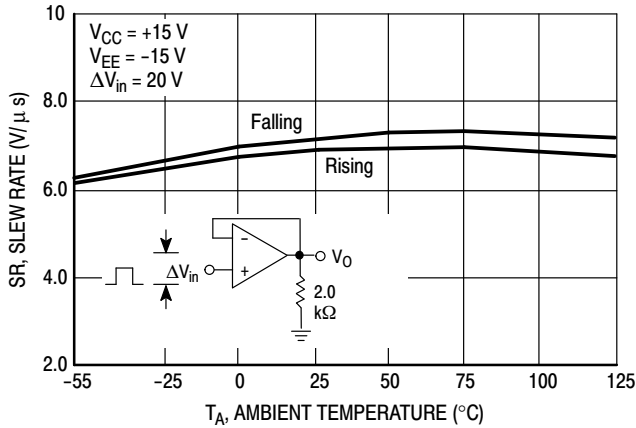
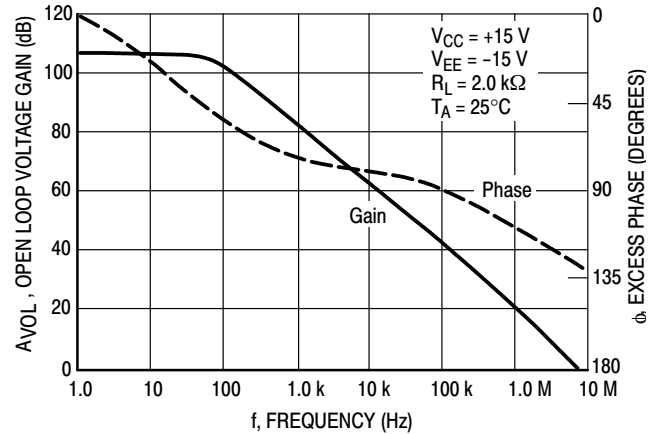
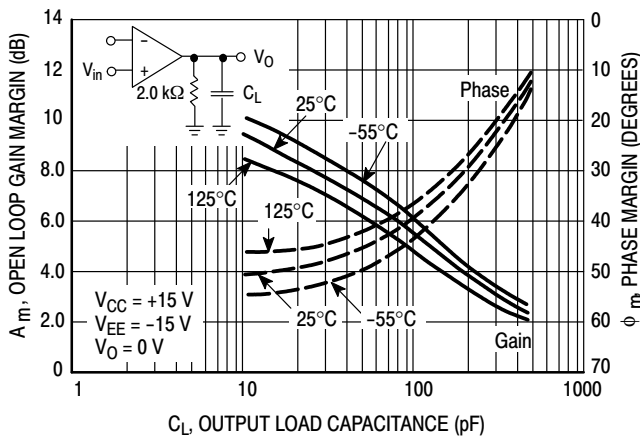
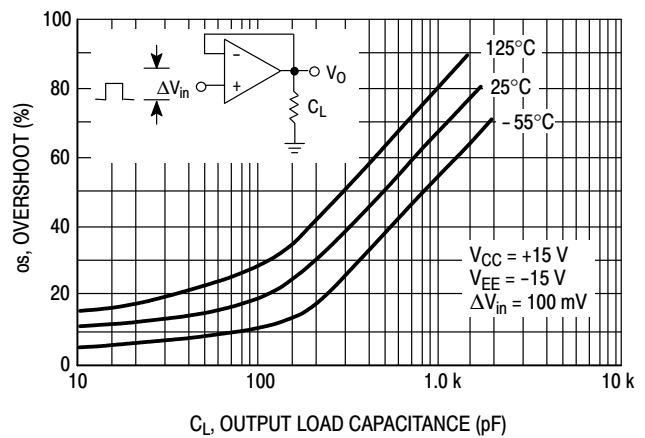
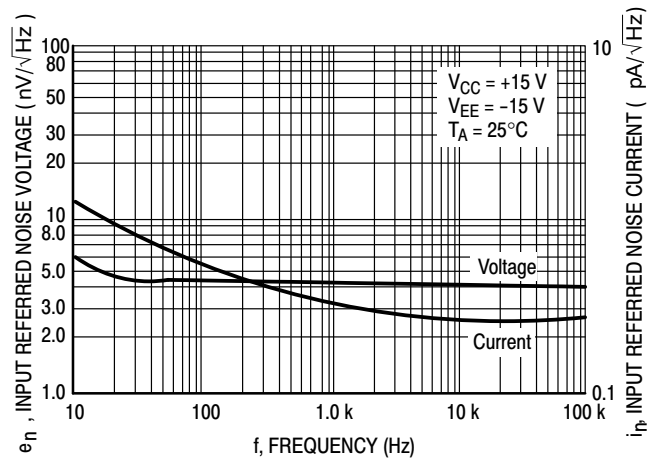
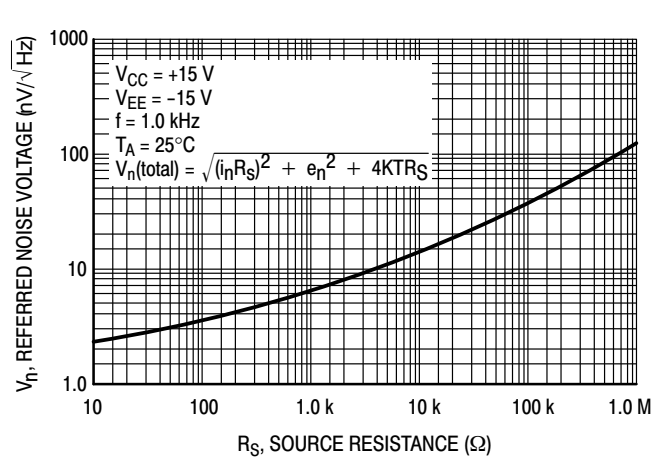

Figure 23. Slew Rate versus Supply Voltage

Figure 24. Slew Rate versus Temperature

Figure 25. Voltage Gain and Phase versus Frequency

Figure 26. Open Loop Gain Margin and Phase Margin versus Load Capacitance

Figure 27. Overshoot versus Output Load Capacitance

Figure 28. Input Referred Noise Voltage and Current versus Frequency

Figure 29. Total Input Referred Noise Voltage versus Source Resistance

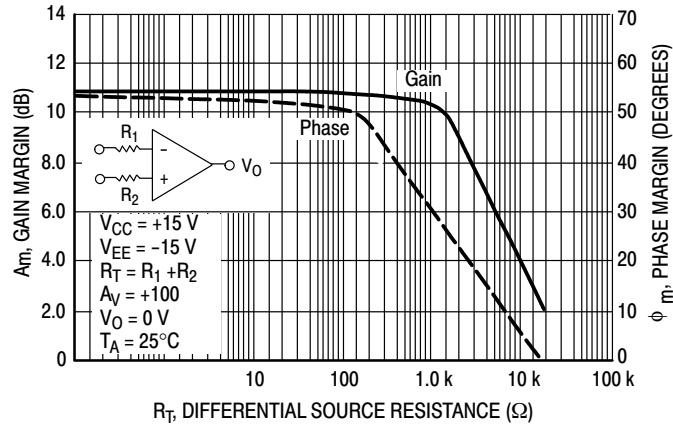

Figure 30. Phase Margin and Gain Margin versus Differential Source Resistance

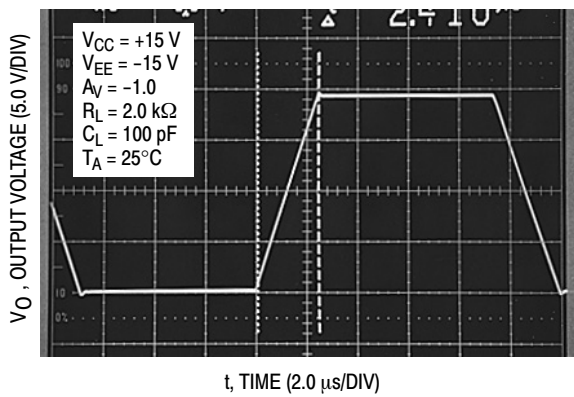

Figure 31. Inverting Amplifier Slew Rate

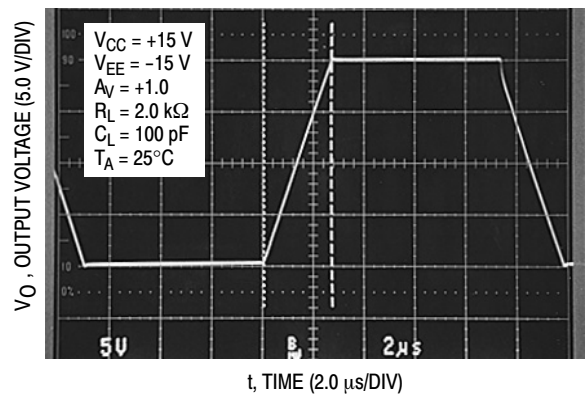

Figure 32. Non-inverting Amplifier Slew Rate

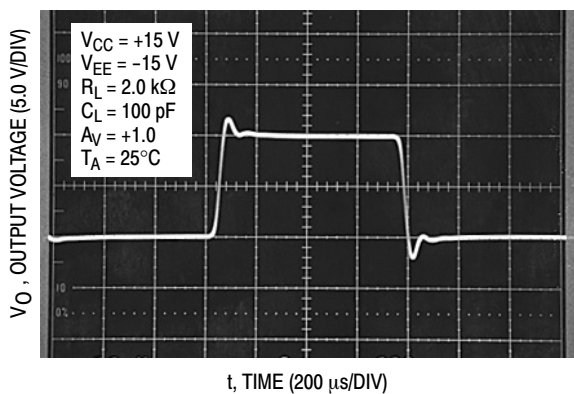

Figure 33. Non-inverting Amplifier Overshoot

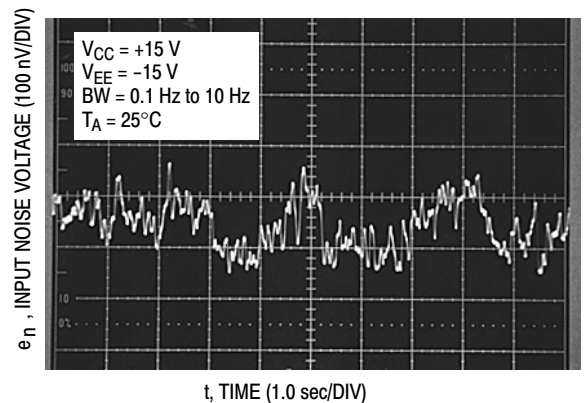
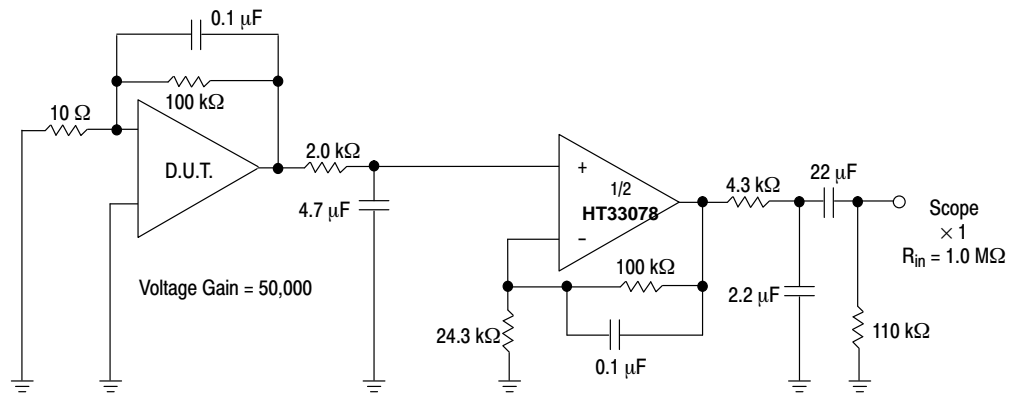
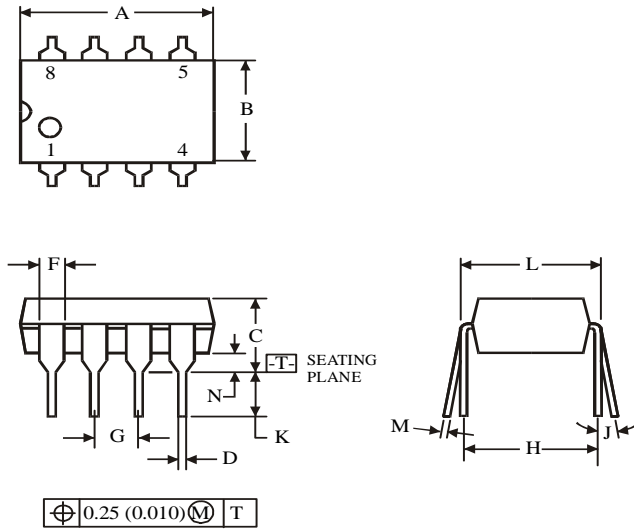
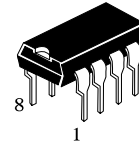

Figure 34. Low Frequency Noise Voltage versus Time



Note: All capacitors are non-polarized.

Figure 35. Voltage Noise Test Circuit
(0.1 Hz to 10 Hz _)

**N SUFFIX PLASTIC DIP
 (MS - 001BA)**

NOTES:

- Dimensions "A", "B" do not include mold flash or protrusions.
Maximum mold flash or protrusions 0.25 mm (0.010) per side.

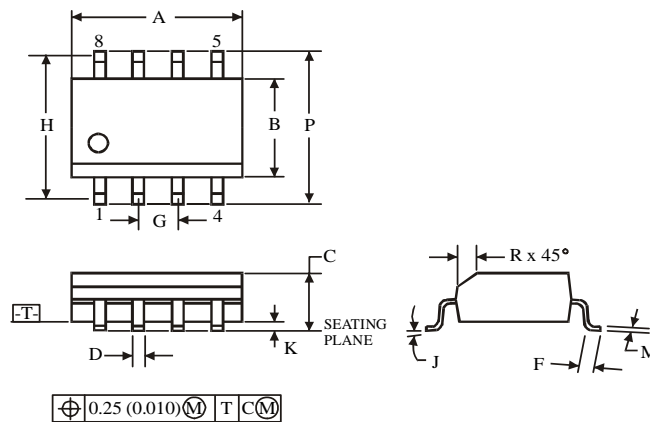
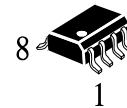
Symbol	Dimension, mm	
	MIN	MAX
A	8.51	10.16
B	6.1	7.11
C		5.33
D	0.36	0.56
F	1.14	1.78
G	2.54	
H	7.62	
J	0°	10°
K	2.92	3.81
L	7.62	8.26
M	0.2	0.36
N	0.38	

**D SUFFIX SOIC
 (MS - 012AA)**

NOTES:

- Dimensions A and B do not include mold flash or protrusion.
- Maximum mold flash or protrusion 0.15 mm (0.006) per side for A; for B - 0.25 mm (0.010) per side.

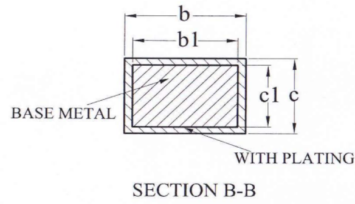
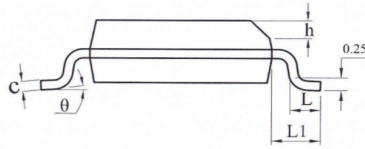
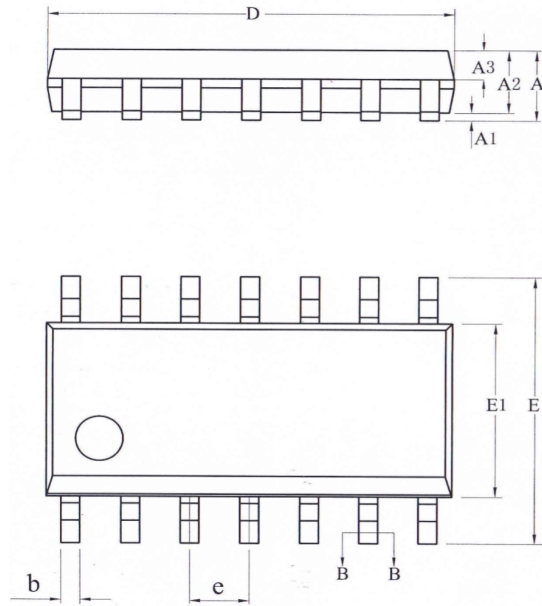
Symbol	Dimension, mm	
	MIN	MAX
A	4.8	5
B	3.8	4
C	1.35	1.75
D	0.33	0.51
F	0.4	1.27
G	1.27	
H	5.72	
J	0°	8°
K	0.1	0.25
M	0.19	0.25
P	5.8	6.2
R	0.25	0.5

SOP14

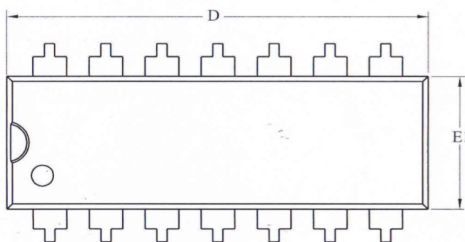
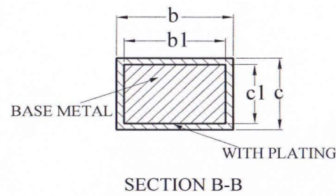
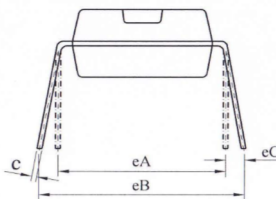
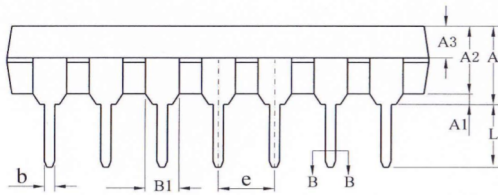
SYMBOL	MILLIMETER		
	MIN	NOM	MAX
A	—	—	1.75
A1	0.05	—	0.225
A2	1.30	1.40	1.50
A3	0.60	0.65	0.70
b	0.39	—	0.47
b1	0.38	0.41	0.44
c	0.20	—	0.24
c1	0.19	0.20	0.21
D	8.55	8.65	8.75
E	5.80	6.00	6.20
E1	3.80	3.90	4.00
e	1.27BSC		
h	0.25	—	0.50
L	0.50	—	0.80
L1	1.05REF		
θ	0	—	8°

DIP14

SYMBOL	MILLIMETER		
	MIN	NOM	MAX
A	3.60	3.80	4.00
A1	0.51	—	—
A2	3.20	3.30	3.40
A3	1.47	1.52	1.57
b	0.44	—	0.52
b1	0.43	0.46	0.49
B1	1.52REF		
c	0.25	—	0.29
c1	0.24	0.25	0.26
D	19.00	19.10	19.20
E1	6.25	6.35	6.45
e	2.54BSC		
eA	7.62REF		
eB	7.62	—	9.30
eC	0	—	0.84
L	3.00	—	—

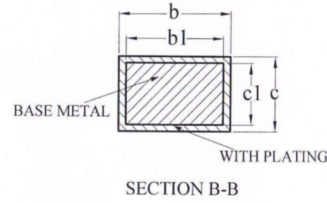
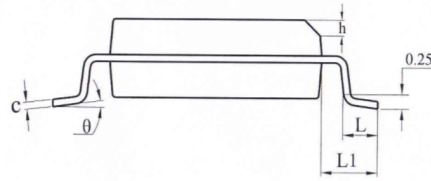
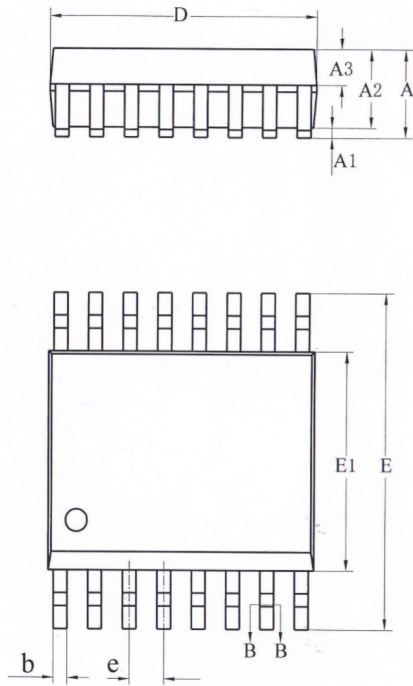
SSOP14

SYMBOL	MILLIMETER		
	MIN	NOM	MAX
A	—	—	1.75
A1	0.10	—	0.225
A2	1.30	1.40	1.50
A3	0.55	0.60	0.65
b	0.23	—	0.31
b1	0.22	0.25	0.28
c	0.20	—	0.24
c1	0.19	0.20	0.21
D	4.80	4.90	5.00
E	5.80	6.00	6.20
E1	3.80	3.90	4.00
e	0.635BSC		
h	0.25	—	0.50
L	0.50	0.65	0.80
L1	1.05REF		
θ	0	—	8°

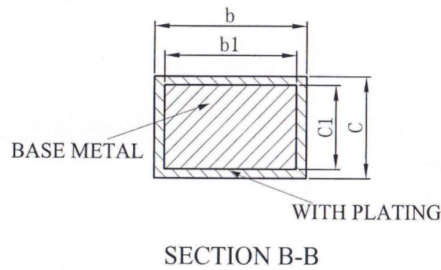
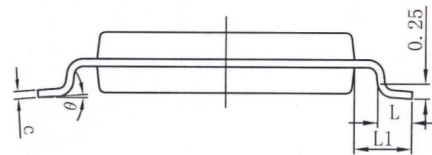
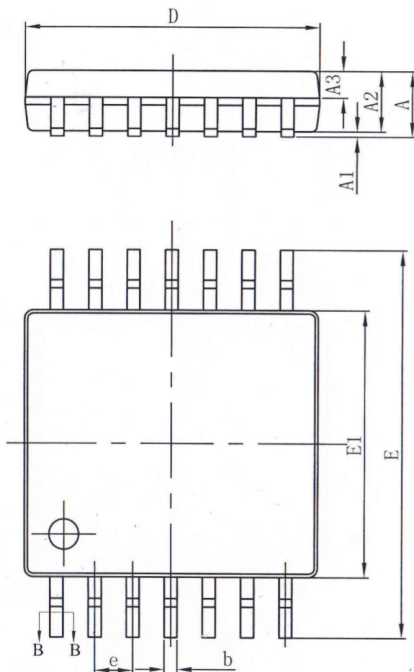
TSSOP14

SYMBOL	MILLIMETER		
	MIN	NOM	MAX
A	—	—	1.20
A1	0.05	—	0.15
A2	0.90	1.00	1.05
A3	0.39	0.44	0.49
b	0.20	—	0.28
b1	0.19	0.22	0.25
c	0.13	—	0.17
c1	0.12	0.13	0.14
D	4.90	5.00	5.10
E1	4.30	4.40	4.50
E	6.20	6.40	6.60
e	0.65BSC		
L	0.45	0.60	0.75
L1	1.00BSC		
θ	0	—	8°