

FEATURE

- Switching Transistor
- Collector-emitter voltage $V_{CE}=40V$
- Collector current $I_C=0.2A$
- Marking:1N

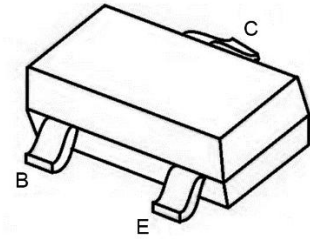

SOT-523

ABSOLUTE MAXIMUM RATINGS (TA=25°C, RH= 45%-75%, unless otherwise noted)

Parameter	Symbol	Value	Unit
Collector Emitter Voltage	V_{CEO}	40	V
Collector Base Voltage	V_{CBO}	60	V
Emitter Base Voltage	V_{EBO}	6	V
Collector Current	I_C	200	mA
Power Dissipation	P_{tot}	150	mW
Thermal Resistance from Junction to Ambient	$R_{\theta JA}$	833	°C/W
Junction Temperature	T_j	150	°C
Storage Temperature Range	T_{stg}	- 55 to + 150	°C

Parameter	Symbol	Test Condition	Min	Max	Unit
Collector-emitter breakdown voltage	BV_{CEO}	$I_C=1mA, I_B=0$	40		V
Collector-base breakdown voltage	BV_{CBO}	$I_C=10\mu A, I_E=0$	60		V
Emitter-base breakdown voltage	BV_{EBO}	$I_E=10\mu A, I_C=0$	6		V
Collector cut-off current	I_{CEX}	$V_{CE}=30V, V_{EB}(off)=3V$		50	nA
Emitter cut-off current	I_{EBO}	$V_{EB}=5V, I_C=0$		100	nA
DC current gain	h_{FE}	$V_{CE}=1V, I_C=0.1mA$	40		
		$V_{CE}=1V, I_C=1mA$	70		
		$V_{CE}=1V, I_C=10mA$	100		300
		$V_{CE}=1V, I_C=50mA$	60		
Collector-emitter saturation voltage	$V_{CE(sat)}$	$I_C=10mA, I_B=1mA$		0.2	V
		$I_C=50mA, I_B=5mA$		0.3	V
Base-emitter saturation voltage	$V_{BE(sat)}$	$I_C=10mA, I_B=1mA$	0.65	0.85	V
		$I_C=50mA, I_B=5mA$		0.95	V
Transition frequency	f_T	$V_{CE}=20V, I_C=10mA, f=100MHz$	300		MHZ

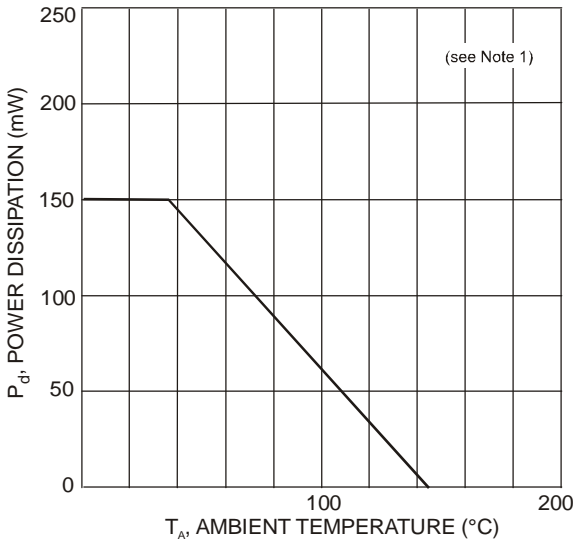

Fig. 1, Power Derating Curve

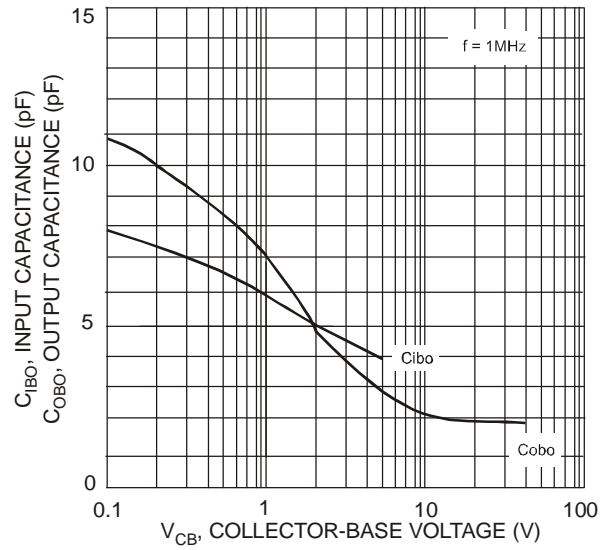

Fig. 2, Input and Output Capacitance vs. Collector-Base Voltage

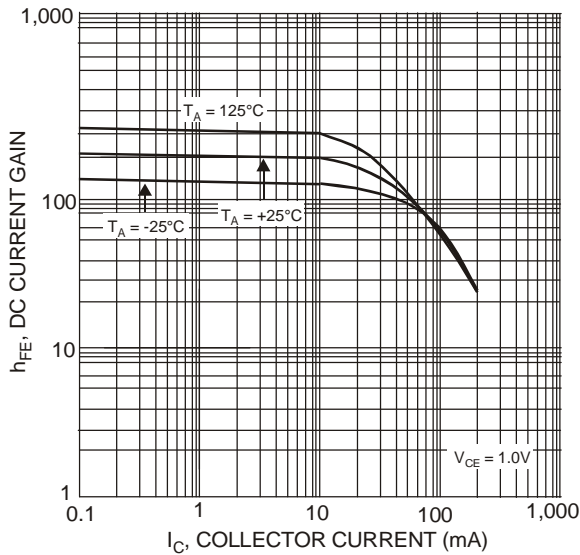

Fig. 3, Typical DC Current Gain vs. Collector Current

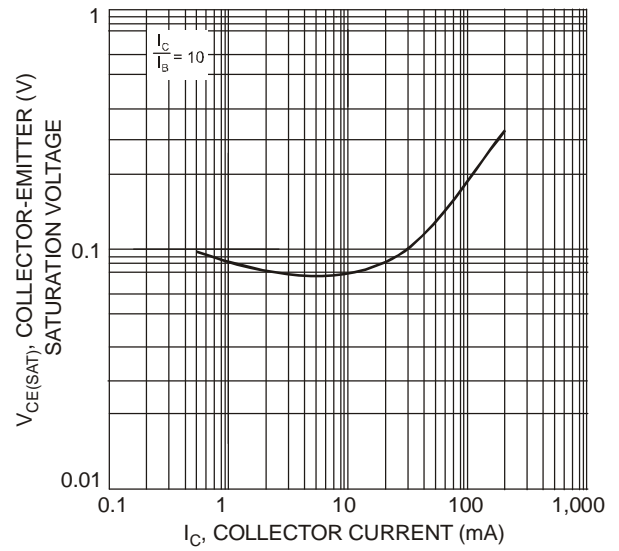

Fig. 4, Typical Collector-Emitter Saturation Voltage vs. Collector Current

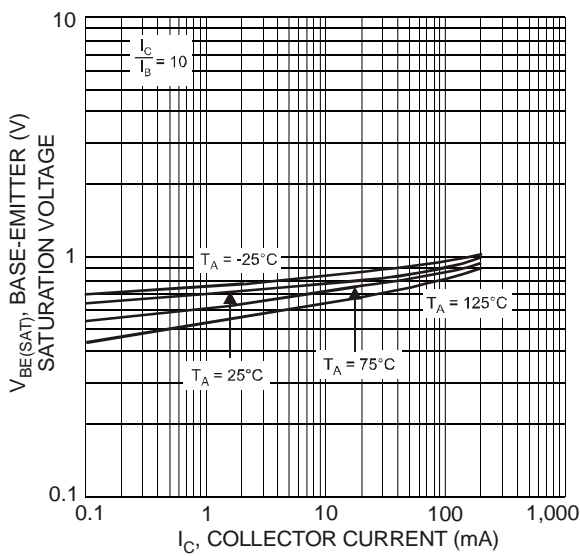
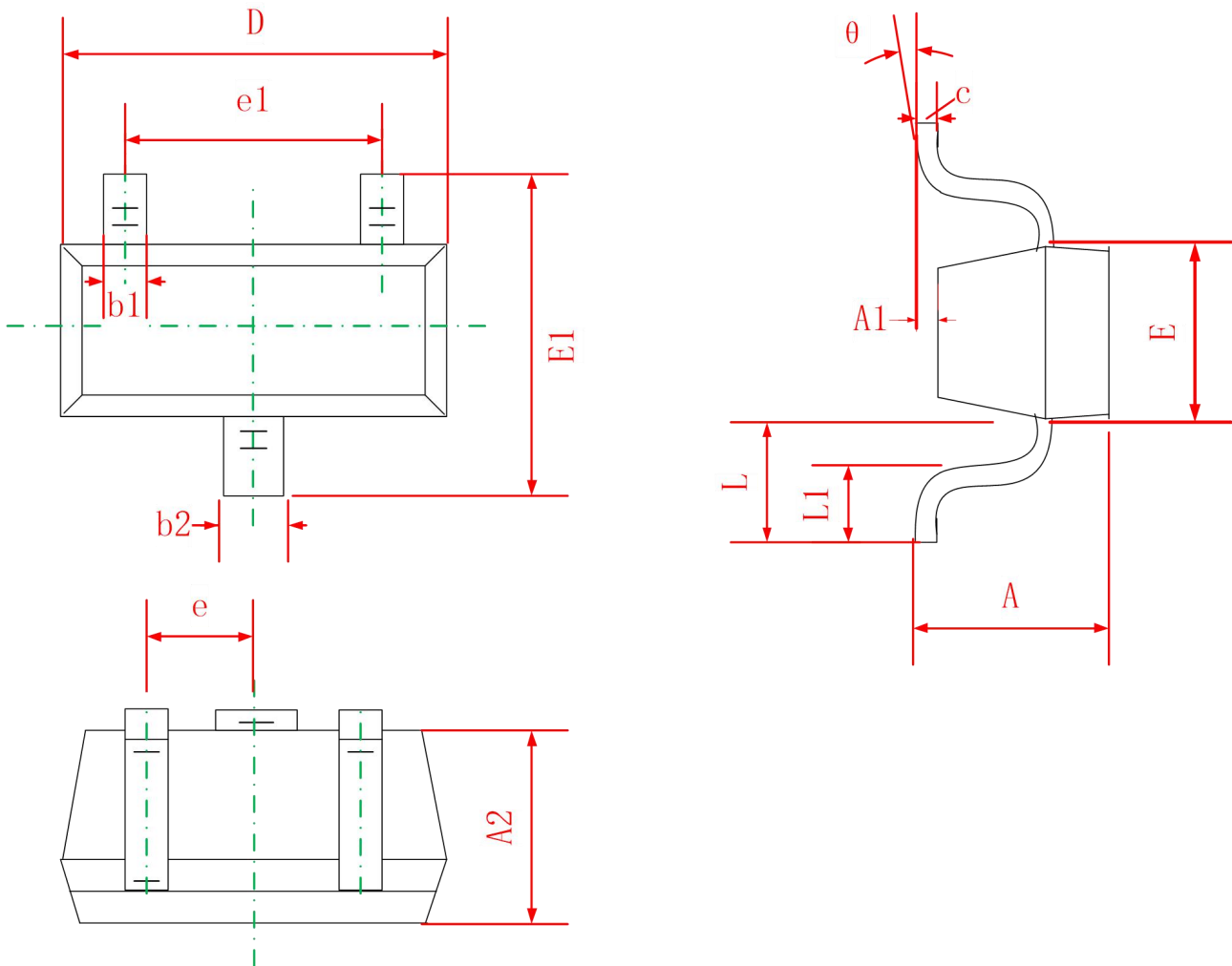

Fig. 5, Typical Base-Emitter Saturation Voltage vs. Collector Current

PACKAGE



Symbol	Dimensions In Millimeters	
	Min	Max
A	0.700	0.900
A1	0.000	0.100
A2	0.700	0.800
b1	0.150	0.250
b2	0.250	0.350
C	0.100	0.200
D	1.500	1.700
E	0.700	0.900
E1	1.450	1.750
e	0.500 TYP	
e1	0.900	1.100
L	0.400 REF	
L1	0.260	0.460
θ	0°	8°

Soldering Parameters

Reflow Condition		Pb – Free assembly
Pre Heat	Temperature Min ($T_{S(min)}$)	150°C
	Temperature Max ($T_{S(max)}$)	200°C
	Time (min to max) (t_s)	60 – 190 secs
Average ramp up rate (Liquidus Temp) (T_L) to peak		5°C/second max
		5°C/second max
Reflow	Temperature (T_L) (Liquidus)	217°C
	Temperature (t_L)	60 – 150 seconds
		260+0/-5 °C
Time within actual peak Temperature (t_p)		20 – 40 seconds
Ramp-down Rate		5°C/second max
Time 25°C to peak Temperature (T_P)		8 minutes Max.
Do not exceed		280°C

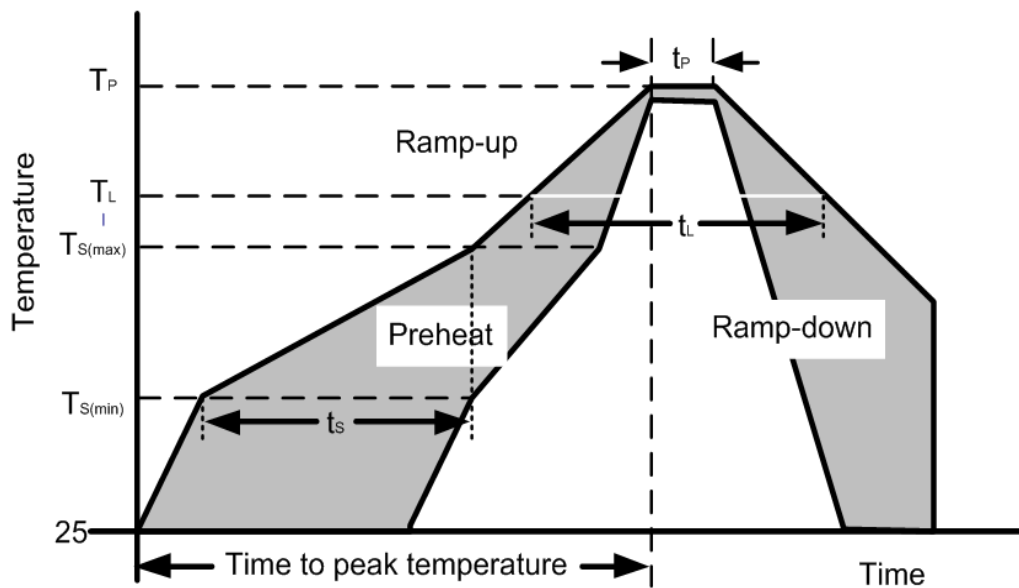

SOT-523 Embossed Carrier Tape

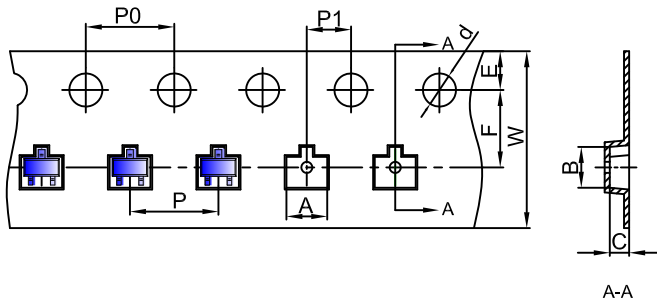

Packaging Description:

SOT-523 parts are shipped in tape. The carrier tape is made from a dissipative (carbon filled) polycarbonate resin. The cover tape is a multilayer film (Heat Activated Adhesive in nature) primarily composed of polyester film, adhesive layer, sealant, and anti-static sprayed agent. These reeled parts in standard option are shipped with 3,000 units per 7" or 17.8cm diameter reel. The reels are clear in color and is made of polystyrene plastic (anti-static coated).

Dimensions are in millimeter											
Pkg type	A	B	C	d	E	F	P0	P	P1	W	
SOT-523	1.85	1.85	0.875	Ø1.50	1.75	3.50	4.00	4.00	2.00	8.00	

SOT-523 Tape Leader and Trailer

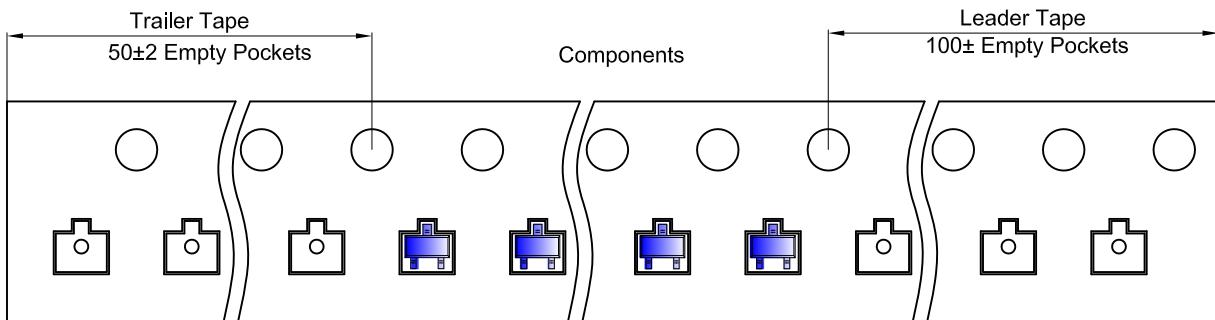

SOT-523 Reel

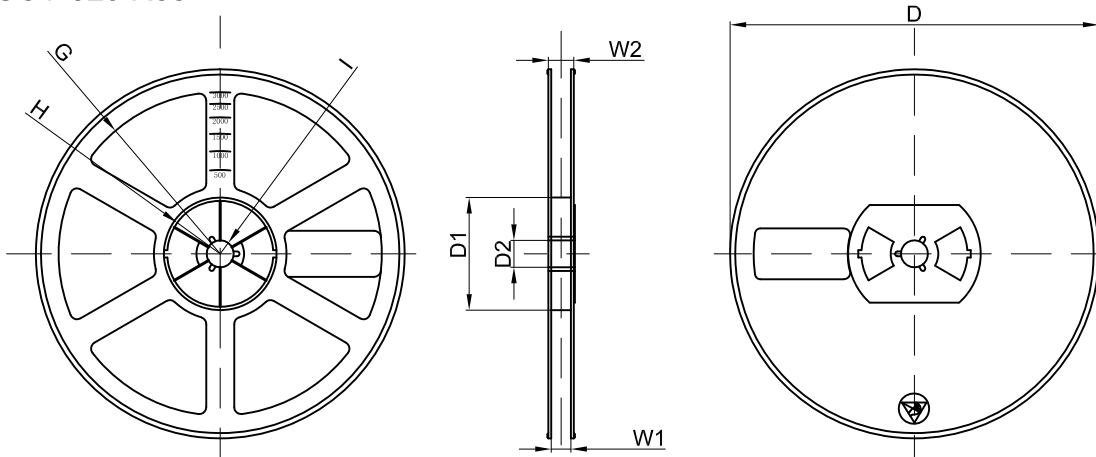

Dimensions are in millimeter								
Reel Option	D	D1	D2	G	H	I	W1	W2
7" Dia	Ø178.00	54.40	13.00	R78.00	R25.60	R6.50	9.50	12.30

REEL	Reel Size	Box	Box Size(mm)	Carton	Carton Size(mm)	G.W.(kg)
3000 pcs	7 inch	45,000 pcs	203×203×195	180,000 pcs	438×438×220	