

修订 REV	标记 MARK	修改摘要 REVISION DESCRIPTION	签名 SIGNATURE	日期 DATE
AO		NEW RELEASE	黄艳兰	2020-12-12

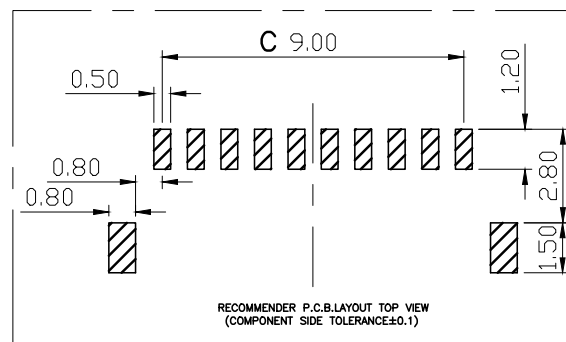
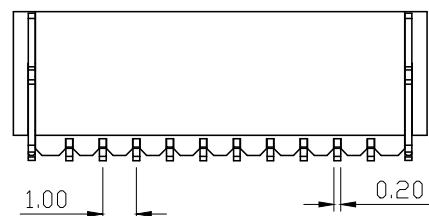
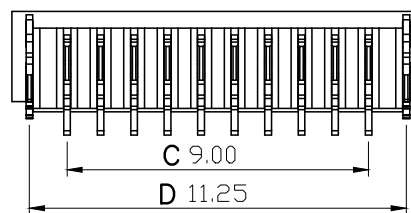
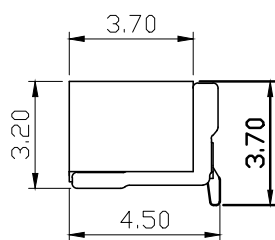
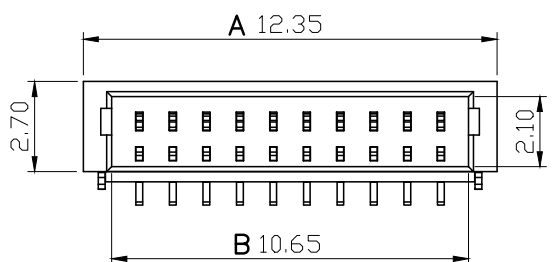
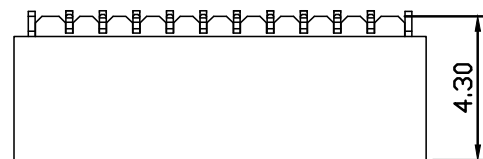
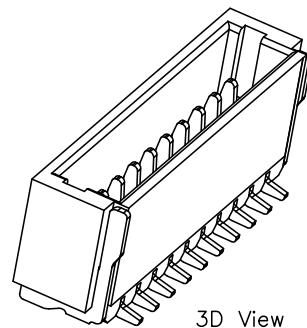

PIN数	A±0.1	B±0.1	C±0.1	D±0.1
2P	4.35	2.65	1.00	3.25
3P	5.35	3.65	2.00	4.25
4P	6.35	4.65	3.00	5.25
5P	7.35	5.65	4.00	6.25
6P	8.35	6.65	5.00	7.25
7P	9.35	7.65	6.00	8.25
8P	10.35	8.65	7.00	9.25
9P	11.35	9.65	8.00	10.25
10P	12.35	10.65	9.00	11.25

Specifications:

- Rated Voltage : 50V AC/DC
- Rated Current : 1A AC,DC
- Withstand Voltage : 200V AC/minute
- Contact Resistance : 50mΩ(MAX.)
- Insulation Resistance : 100MΩ(MIN.)
- Storage Temperature Range:-40°C~+85°C;
- Operation Temperature Range:-25°C~+70°C;

3	插片	黄铜H65	镀镍锡	
2	插针	黄铜H65	镀镍锡	
1	基座	LCP	本色	
序号	品名	材质	电镀/颜色	备注

**HDGC** 深圳市华德共创科技有限公司  
Shenzhen Huade co-create Technology Co.,LTD  
TEL : 0755-27129737 FAX : 0755-29940187

-TOLERANCES- UNLESS OTHERWISE SPECIFIED 公差参数表				TITLE: 产品名称: SH1.0针座立贴	
X.X	±0.30	X.X°	±3°	APPD: 核准: 谢亮	PART NO: 产品编号: HDGC1002WV-S-XP
X.XX	±0.30	X.XX°	±2°	CHECK: 校对: 王建业	DATE
X.XXX	±0.10	X.XXX°	±1°	DRAW: 绘图: 黄艳兰	SCALE
					UNIT
					CODE NUMBER