

FH8712BG2

N- Channel Enhancement Mode Power MOSFET

Description

The FH8712BG2 uses advanced trench technology to provide excellent $R_{DS(ON)}$, low gate charge and operation with gate voltages as low as 2.5V. This device is suitable for use as a load switch or in PWM applications.

Application

- PWM application
- Load switch

General Features

- $V_{DS} = 20V, I_D = 7.8A$
- $R_{DS(ON)} < 13.5m\Omega$ (MAX) @ $V_{GS}=4.5V$
- $R_{DS(ON)} < 14.5m\Omega$ (MAX) @ $V_{GS}=3.8V$
- $R_{DS(ON)} < 16m\Omega$ (MAX) @ $V_{GS}=2.5V$
- High Power and current handling capability
- Lead free product is acquired
- Surface Mount Package

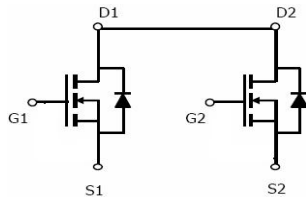

Schematic diagram



Marking and pin Assignment

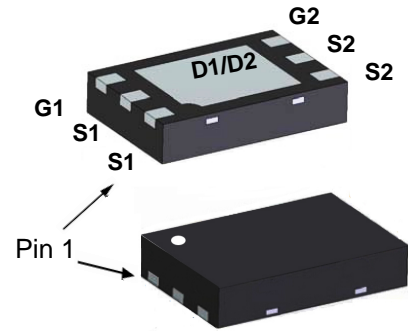

DFN2x3-6L Pin assignment and Top / Bottom View

Absolute Maximum Ratings (TA=25°C unless otherwise noted)

Parameter	Symbol	Limit	Unit
Drain-Source Voltage	V_{DS}	20	V
Gate-Source Voltage	V_{GS}	±12	V
Drain Current-Continuous (Note 1)	I_D	7.8	A
Drain Current-Pulsed (Note 1, Note 3)	I_{DM}	30	A
Maximum Power Dissipation	P_D	1.5	W
Operating Junction and Storage Temperature Range	T_J, T_{STG}	-55 To 150	°C

Thermal Characteristic

Thermal Resistance, Junction-to-Ambient (Note 2)	$R_{\theta JA}$	89	°C/W
--	-----------------	----	------

Electrical Characteristics (TA=25°C unless otherwise noted)

Parameter	Symbol	Condition	Min	Typ	Max	Unit
Off Characteristics						
Drain-Source Breakdown Voltage	BV_{DSS}	$V_{GS}=0V, I_D=250\mu A$	20		-	V
Zero Gate Voltage Drain Current	I_{DSS}	$V_{DS}=20V, V_{GS}=0V$	-	-	1	μA
Gate-Body Leakage Current	I_{GSS}	$V_{GS}=\pm 12V, V_{DS}=0V$	-	-	± 100	nA
On Characteristics (Note 3)						
Gate Threshold Voltage	$V_{GS(th)}$	$V_{DS}=V_{GS}, I_D=250\mu A$	0.45	0.7	1.00	V
Drain-Source On-State Resistance	$R_{DS(on)}$	$V_{GS}=4.5V, I_D=5.0A$	-	11	13.5	m Ω
		$V_{GS}=3.8V, I_D=5.0A$	-	12	14.5	m Ω
		$V_{GS}=2.5V, I_D=4A$	-	13	16	m Ω
Forward Transconductance	g_{FS}	$V_{DS}=5V, I_D=7A$	-	20	-	S
Dynamic Characteristics (Note4)						
Input Capacitance	C_{iss}	$V_{DS}=10V, V_{GS}=0V,$ $F=1.0MHz$	-	1180	-	PF
Output Capacitance	C_{oss}		-	205	-	PF
Reverse Transfer Capacitance	C_{rss}		-	165	-	PF
Switching Characteristics (Note 4)						
Turn-on Delay Time	$t_{d(on)}$	$V_{DD}=10V, R_L=1.35\Omega$ $V_{GS}=5V, R_{GEN}=3\Omega$	-	8	-	nS
Turn-on Rise Time	t_r		-	13	-	nS
Turn-Off Delay Time	$t_{d(off)}$		-	58	-	nS
Turn-Off Fall Time	t_f		-	16	-	nS
Total Gate Charge	Q_g	$V_{DS}=10V, I_D=7A,$ $V_{GS}=4.5V$	-	15	-	nC
Gate-Source Charge	Q_{gs}		-	0.8	-	nC
Gate-Drain Charge	Q_{gd}		-	3.2	-	nC
Drain-Source Diode Characteristics						
Diode Forward Voltage (Note 3)	V_{SD}	$V_{GS}=0V, I_S=1A$	-	-	1.2	V
Diode Forward Current (Note 2)	I_S		-	-	7	A

Notes:

1. Repetitive Rating: Pulse width limited by maximum junction temperature.
2. Surface Mounted on FR4 Board, $t \leq 10$ sec.
3. Pulse Test: Pulse Width $\leq 300\mu s$, Duty Cycle $\leq 2\%$.
4. Guaranteed by design, not subject to production

TYPICAL ELECTRICAL AND THERMAL CHARACTERISTICS

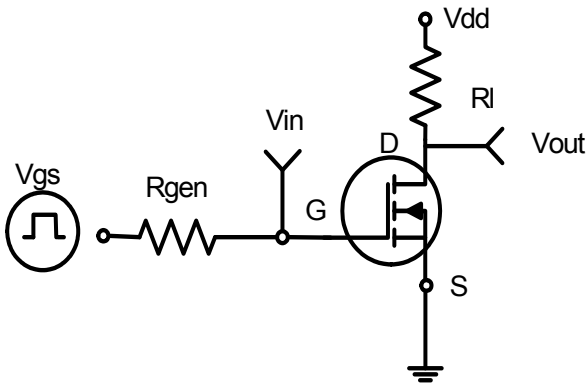

Figure 1: Switching Test Circuit

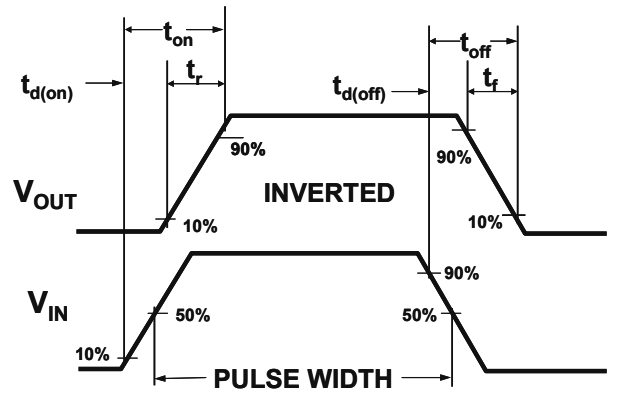

Figure 2: Switching Waveforms

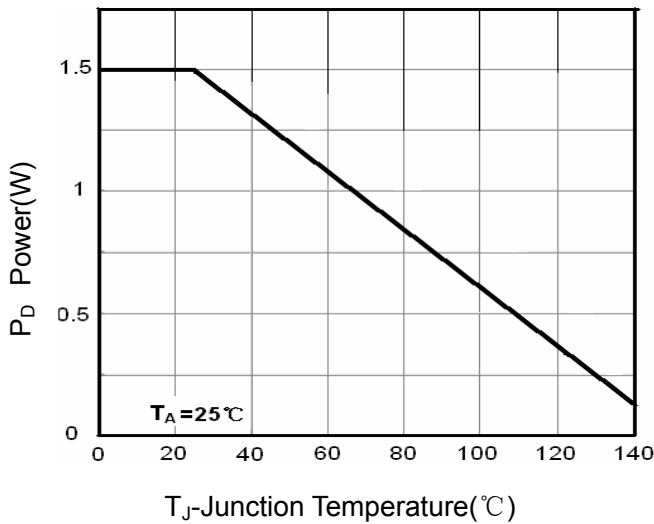

Figure 3 Power Dissipation

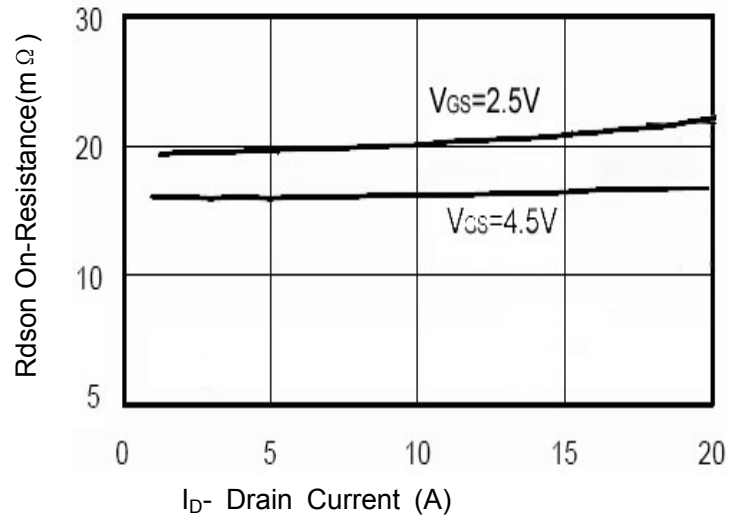

Figure 6 Drain-Source On-Resistance

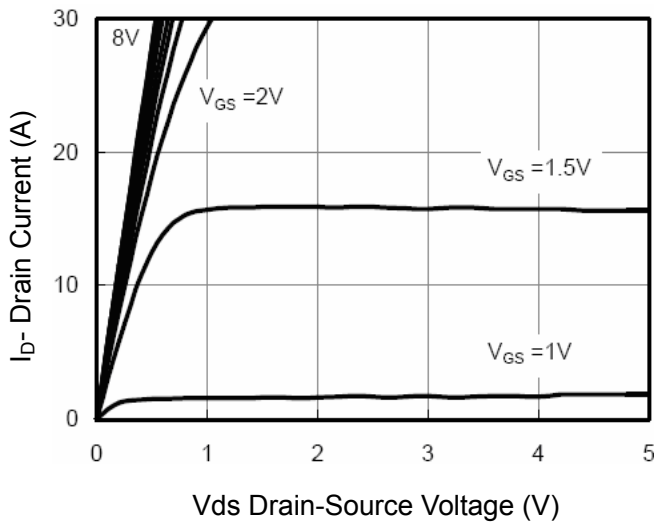

Figure 5 Output CHARACTERISTICS

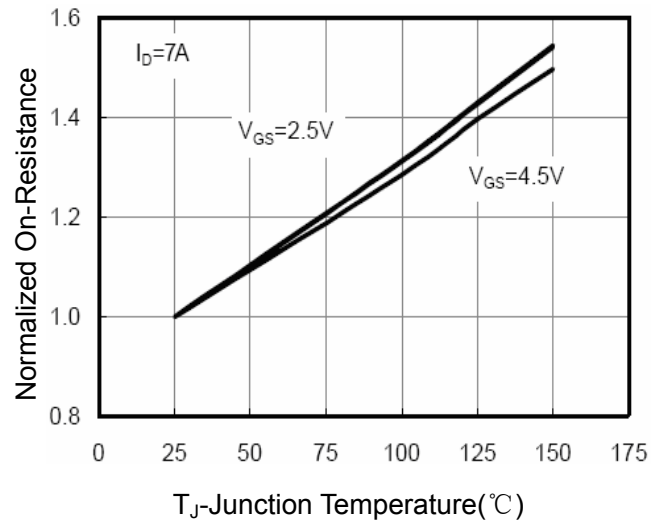
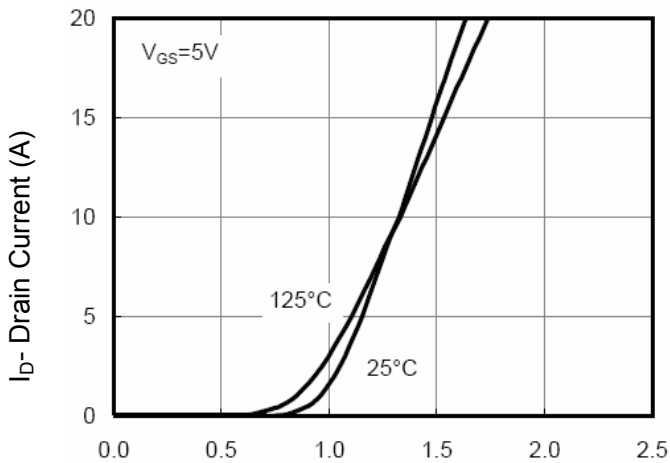
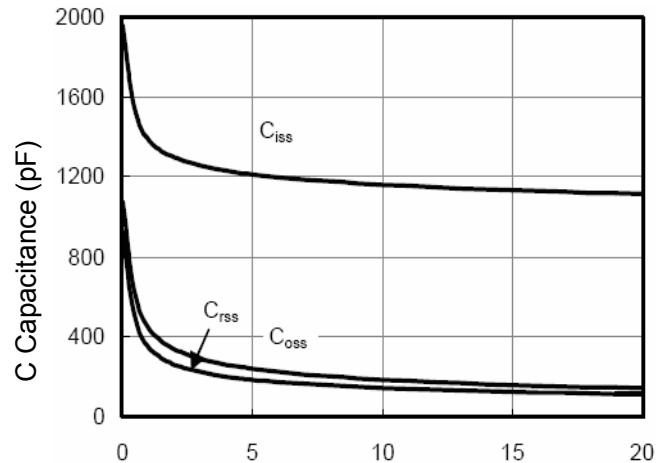

Figure 8 Drain-Source On-Resistance



Vgs Gate-Source Voltage (V)
Figure 7 Transfer Characteristics



Vds Drain-Source Voltage (V)
Figure 8 Capacitance vs Vds

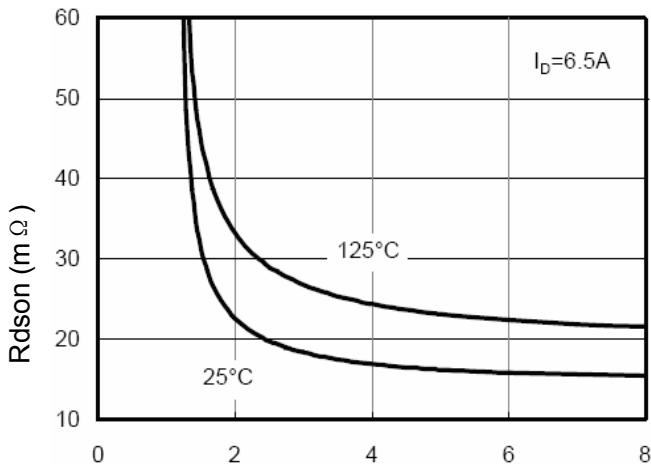

Vgs Gate-Source Voltage (V)
Figure 9 Rdson vs Vgs

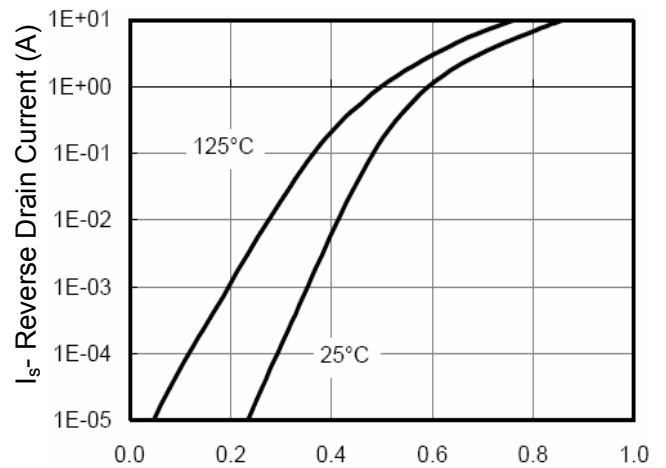

Vds Drain-Source Voltage (V)
Figure 10 Capacitance vs Vds

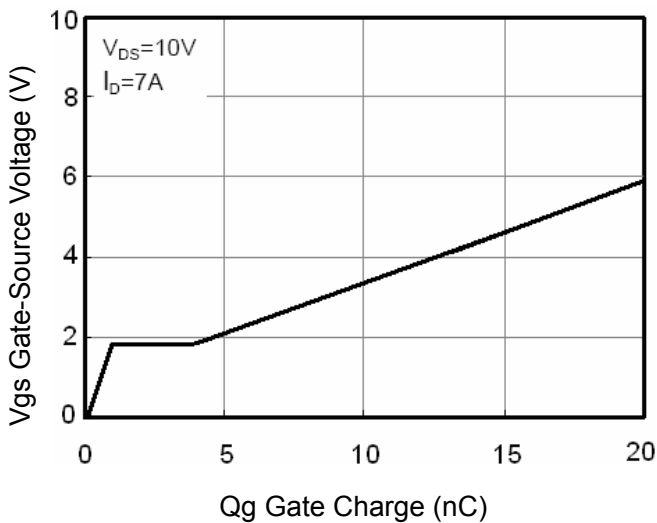

Figure 11 Gate Charge

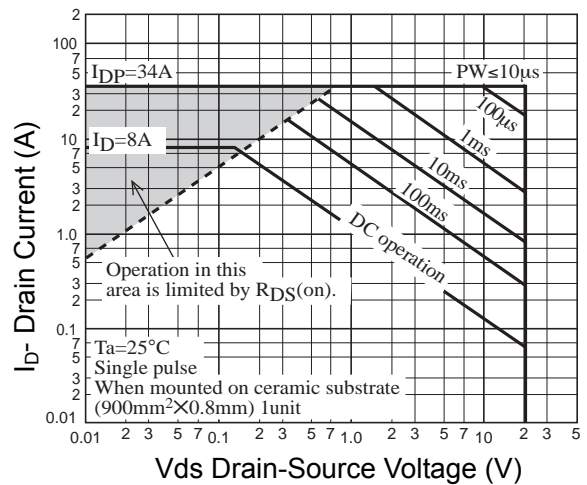

Figure 13 Safe Operation Area

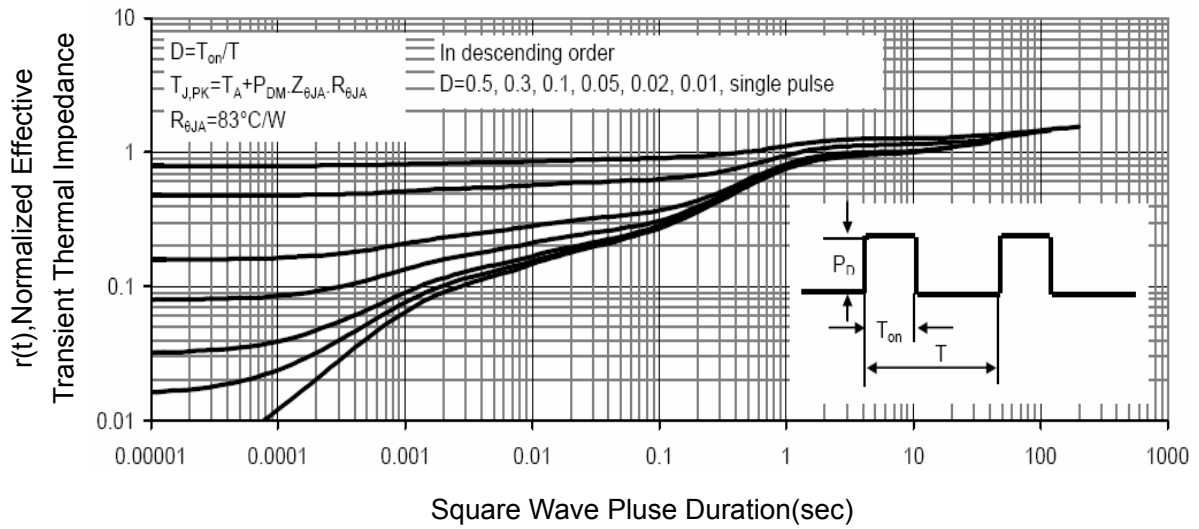
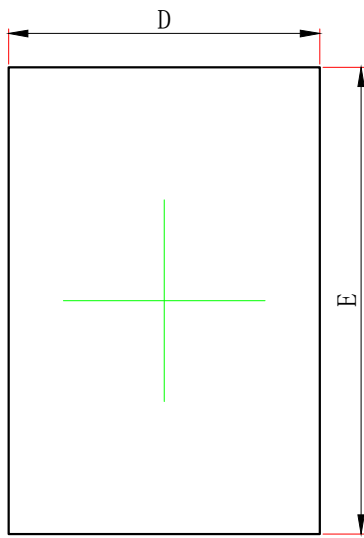
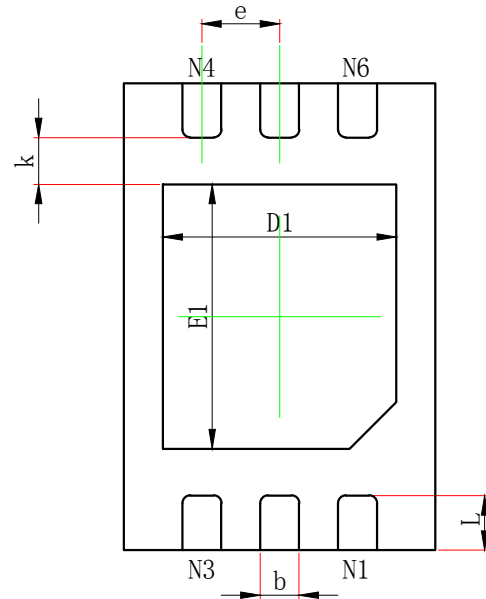

Figure 14 Normalized Maximum Transient Thermal Impedance

Package Outline Dimensions : DFN2X3-6L



TOPVIEW



BOTTOMVIEW

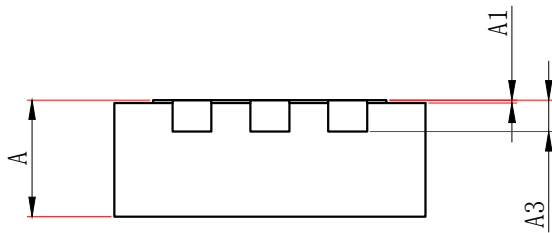

SIDEVIEW

Symbol	Dimensions In Millimeters		Dimensions In Inches	
	Min.	Max.	Min.	Max.
A	0.700	0.800	0.028	0.031
A1	0.000	0.050	0.000	0.002
A3	0.203REF.		0.008REF.	
D	1.950	2.050	0.077	0.081
E	2.950	3.050	0.116	0.120
D1	1.450	1.550	0.057	0.061
E1	1.650	1.750	0.065	0.069
k	0.200MIN.		0.008MIN.	
b	0.200	0.300	0.008	0.012
e	0.500TYP.		0.020TYP.	
L	0.300	0.400	0.012	0.016