

TOP VIEW

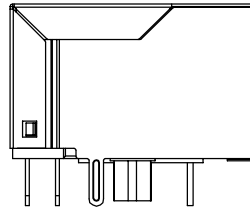

LEFT SIDE VIEW

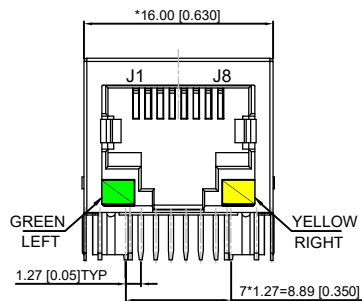

FRONT VIEW

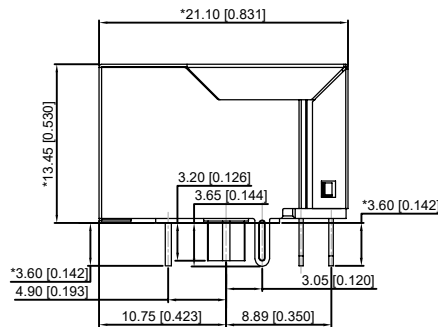

RIGHT SIDE VIEW

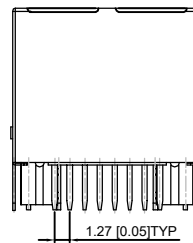

BACK VIEW

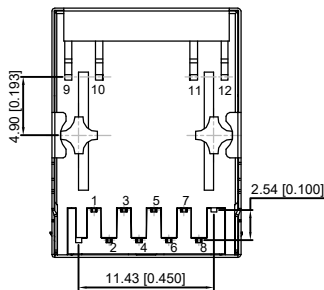

BOTTOM VIEW

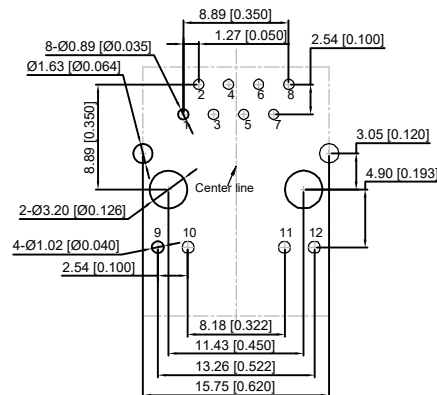

RECOMMENDED PCB LAYOUT VIEWED FROM COMPONENT SIDE

XKB Connectivity

Electrical 电气:

- 1.Voltage rating 额定电压:125V AC.
- 2 Insulation resistance 绝缘电阻: 500 meg a ohms minimum initial after 500V DC for 1minute
- 3.Low level Contact resistance 低阶接触阻抗:
Single terminal 30 milliohms Max initial
50 milliohms maximum after durability test

LED Specification

Standard LED Color	LED Wavelength	Forward(A)	Forward(V)
Green	568nm	20mA	1.85 ~2.45V
Yellow	585nm	20mA	1.7~2.2V

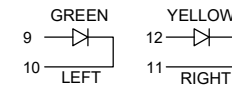

XKB Connectivity

MATERIAL 材料:

- HOUSING : PBT,UL94V-0,BLACK.
- TERMINALS BRACKET 端子支架: PBT,UL94V-0,BLACK.
- SHIELD 保护物: C2680,T=0.20MM,NICKEL PLATING ON ALL AREA.
- TERMINAL 端子: PHOSPHOR BRONZE C5210,T=0.35MM, GOLD PLATING ON CONTACT AREA.

MECHANICAL 机械:

- DURABILITY 耐用性: 750 CYCLES MIN.
- MATING FORCE 配合力: 23N MAX.
- OPERATING TEMPERATURE 工作温度: -40°C~+85°C.
- STORAGE TEMPERATURE 储存温度: -40°C~+85°C.
- ALL CRITICAL DIMENSIONS WITH "**"

MARK	DESCRIPTION	DATE	REVISED	APPROVED	UNSPECIFIED TOLERANCES
					ANGLAR ±5°
					L ≤ 4 ±0.2
					4 < L ≤ 16 ±0.3
					16 < L ≤ 63 ±0.4
					L > 63 ±0.5
					UNSPECIFIED TOLERANCES

DSND	DATE	SCALE: N/A	MODEL TYPE: RJ JACK
DWN	DATE	VIEW:	PART NO.:
CHKD	DATE	UNIT: mm/in	DWG NO.:
APPD	DATE	SIZE: A4	X01AB035BA2AD
XKB INDUSTRIAL PRECISION CO.,LIMITED			WEIGHT 1.0g
			SHEET 1/1
			REVISION A0