

Product Summary

- $V_{DS} = -30V$, $I_D = -4.1A$
 $R_{DS(ON)} < 55m\Omega @ V_{GS} = -10V$
 $R_{DS(ON)} < 85m\Omega @ V_{GS} = -4.5V$
- Advanced Trench Technology
- Excellent $R_{DS(ON)}$ and Low Gate Charge
- Lead free product is acquired

Application

- PWM Applications
- Load Switch
- Power Management

Package and Pin Configuration

SOT-23



Circuit diagram

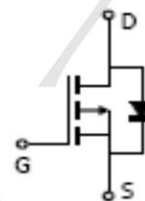

Absolute Maximum Ratings ($T_A = 25^\circ C$ unless otherwise noted)

Symbol	Parameter	Max.	Units	
V_{DSS}	Drain-Source Voltage	-30	V	
V_{GSS}	Gate-Source Voltage	± 20	V	
I_D	Continuous Drain Current	$T_A = 25^\circ C$	-4.1	A
		$T_A = 100^\circ C$	-2.7	A
I_{DM}	Pulsed Drain Current ^{note1}	-16.4	A	
P_D	Power Dissipation	$T_A = 25^\circ C$	1.51	W
$R_{\theta JA}$	Thermal Resistance, Junction to Ambient	83	$^\circ C/W$	
T_J, T_{STG}	Operating and Storage Temperature Range	-55 to +150	$^\circ C$	

Electrical Characteristics ($T_A = 25^\circ\text{C}$ unless otherwise noted)

Symbol	Parameter	Test Condition	Min.	Typ.	Max.	Units
Off Characteristic						
$V_{(BR)DSS}$	Drain-Source Breakdown Voltage	$V_{GS} = 0V, I_D = -250\mu A$	-30	-	-	V
I_{DSS}	Zero Gate Voltage Drain Current	$V_{DS} = -30V, V_{GS} = 0V,$	-	-	-1	μA
I_{GSS}	Gate to Body Leakage Current	$V_{DS} = 0V, V_{GS} = \pm 20V$	-	-	± 100	nA
On Characteristics						
$V_{GS(th)}$	Gate Threshold Voltage	$V_{DS} = V_{GS}, I_D = -250\mu A$	-1.0	-1.5	-2.5	V
$R_{DS(on)}$	Static Drain-Source on-Resistance <small>note2</small>	$V_{GS} = -10V, I_D = -4A$	-	42	55	m Ω
		$V_{GS} = -4.5V, I_D = -3A$	-	62	85	
Dynamic Characteristics						
C_{iss}	Input Capacitance	$V_{DS} = -15V, V_{GS} = 0V,$ $f = 1.0MHz$	-	580	-	pF
C_{oss}	Output Capacitance		-	98	-	pF
C_{riss}	Reverse Transfer Capacitance		-	74	-	pF
Q_g	Total Gate Charge	$V_{DS} = -15V, I_D = -4.1A,$ $V_{GS} = -10V$	-	6.8	-	nC
Q_{gs}	Gate-Source Charge		-	1	-	nC
Q_{gd}	Gate-Drain("Miller") Charge		-	1.4	-	nC
Switching Characteristics						
$t_{d(on)}$	Turn-on Delay Time	$V_{DD} = -15V, I_D = -1A,$ $V_{GS} = -10V, R_{GEN} = 2.5\Omega$	-	14	-	ns
t_r	Turn-on Rise Time		-	61	-	ns
$t_{d(off)}$	Turn-off Delay Time		-	19	-	ns
t_f	Turn-off Fall Time		-	10	-	ns
Drain-Source Diode Characteristics and Maximum Ratings						
I_S	Maximum Continuous Drain to Source Diode Forward Current		-	-	-4.1	A
I_{SM}	Maximum Pulsed Drain to Source Diode Forward Current		-	-	-16.4	A
V_{SD}	Drain to Source Diode Forward Voltage	$V_{GS} = 0V, I_S = -4.1A$	-	-0.8	-1.2	V

Typical Electrical and Thermal Characteristics

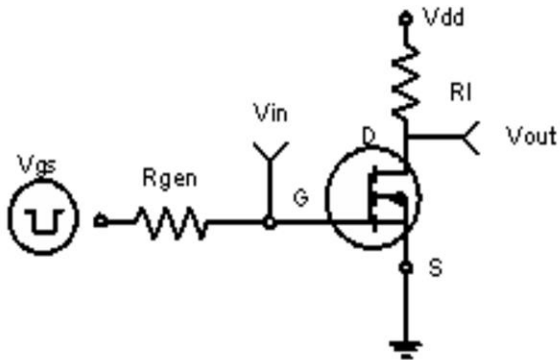

Figure 1: Switching Test Circuit

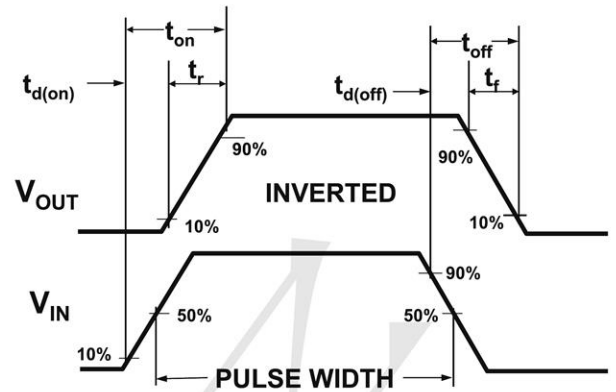

Figure 2: Switching Waveforms

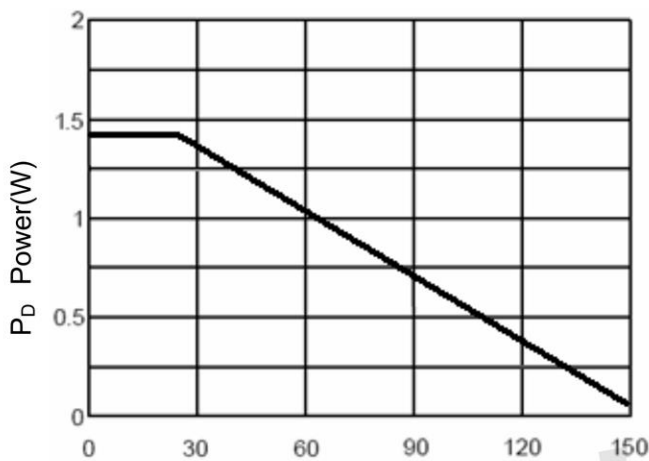

Figure 3 Power Dissipation

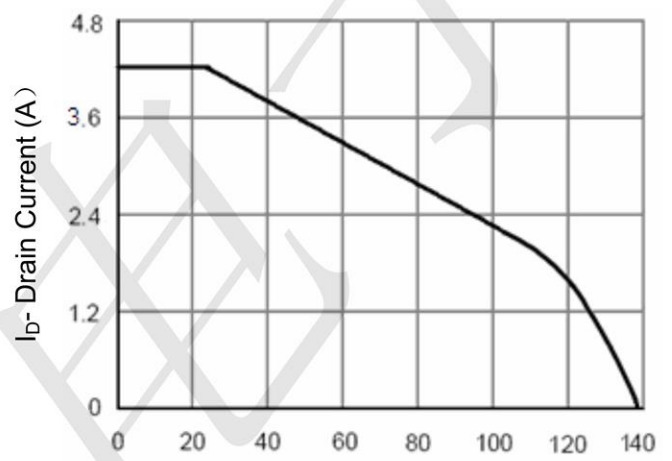

Figure 4 Drain Current

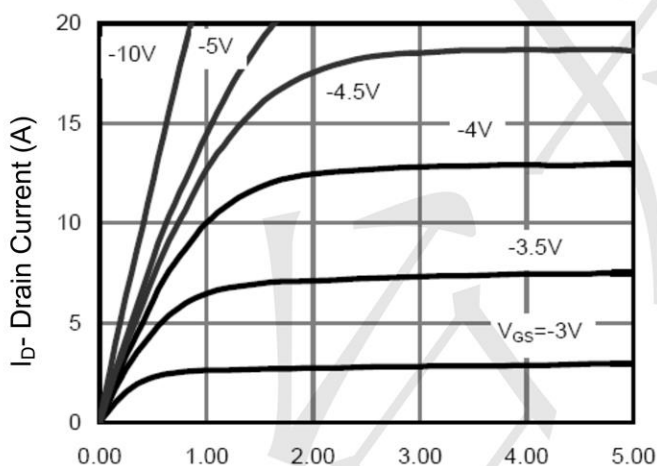

Figure 5 Output Characteristics

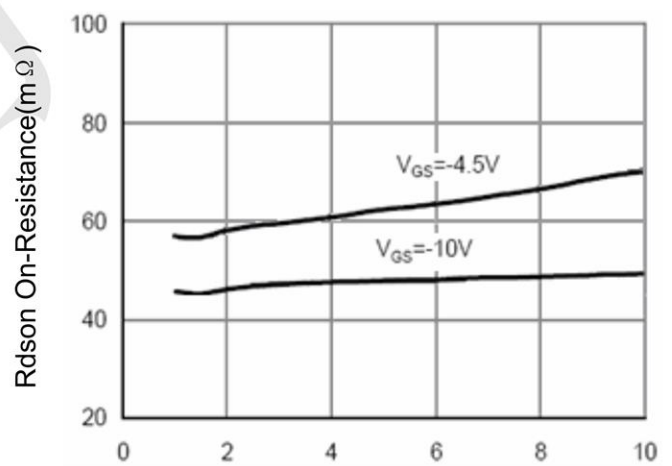

Figure 6 Drain-Source On-Resistance

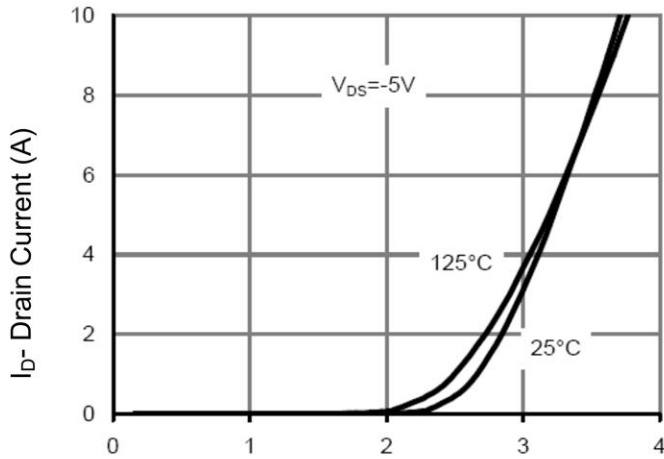

Figure 7 Transfer Characteristics

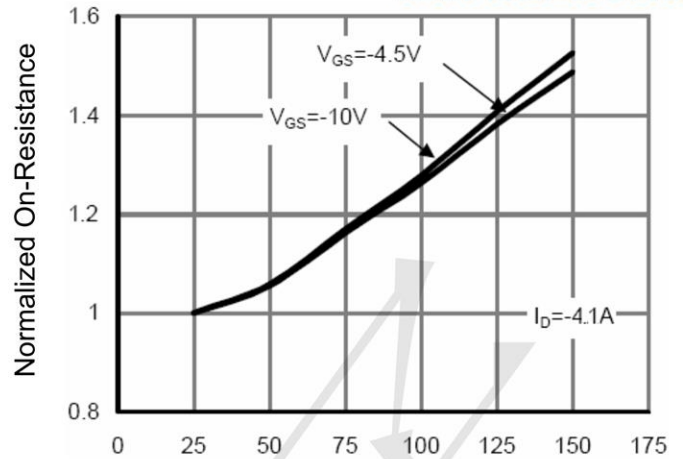

Figure 8 Drain-Source On-Resistance

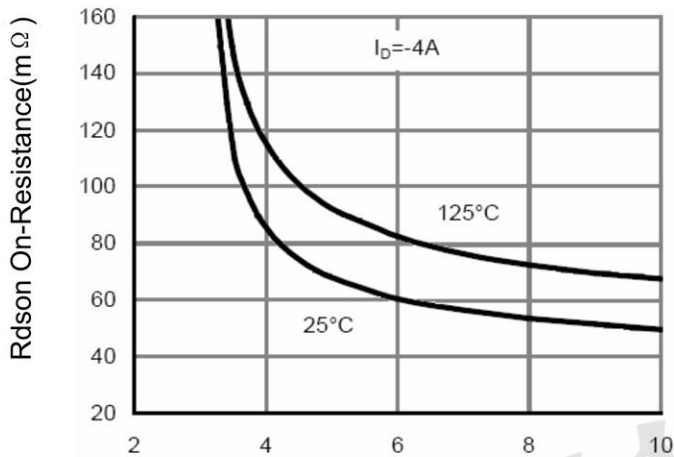

Figure 9 Rdson vs Vgs

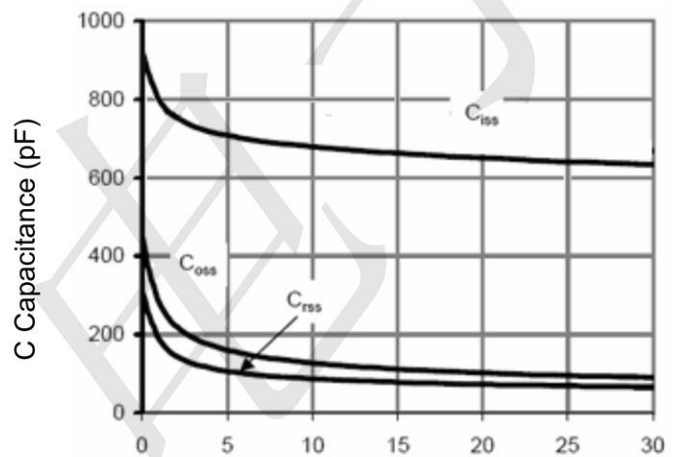

Figure 10 Capacitance vs Vds

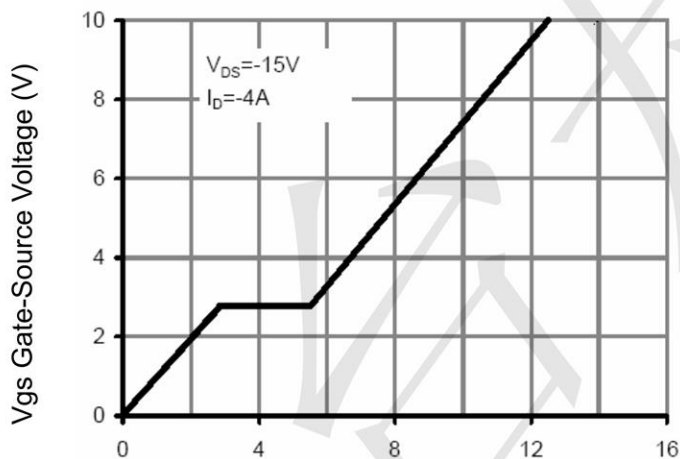

Figure 11 Gate Charge

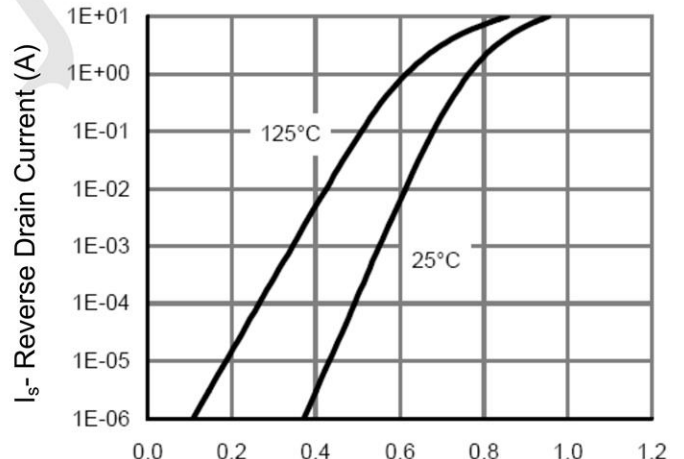

Figure 12 Source- Drain Diode Forward

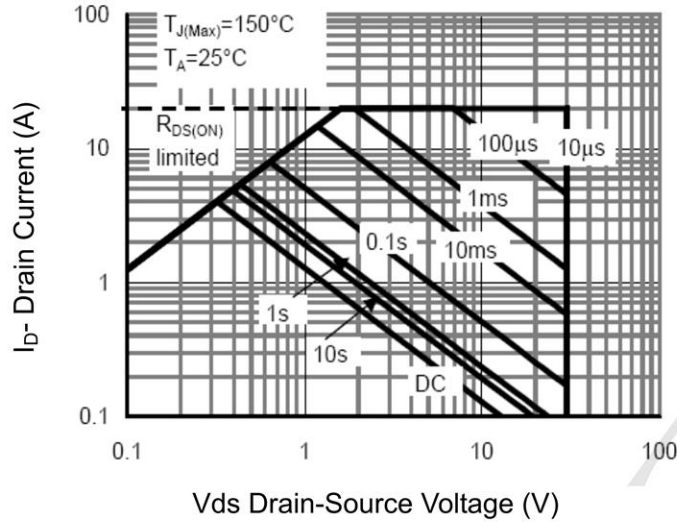

Figure 13 Safe Operation Area

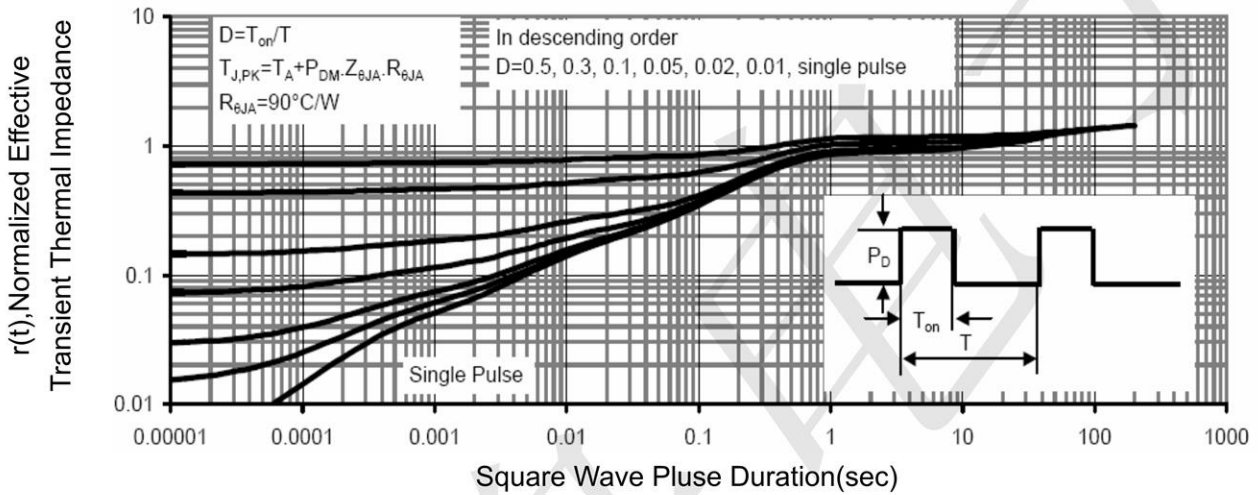
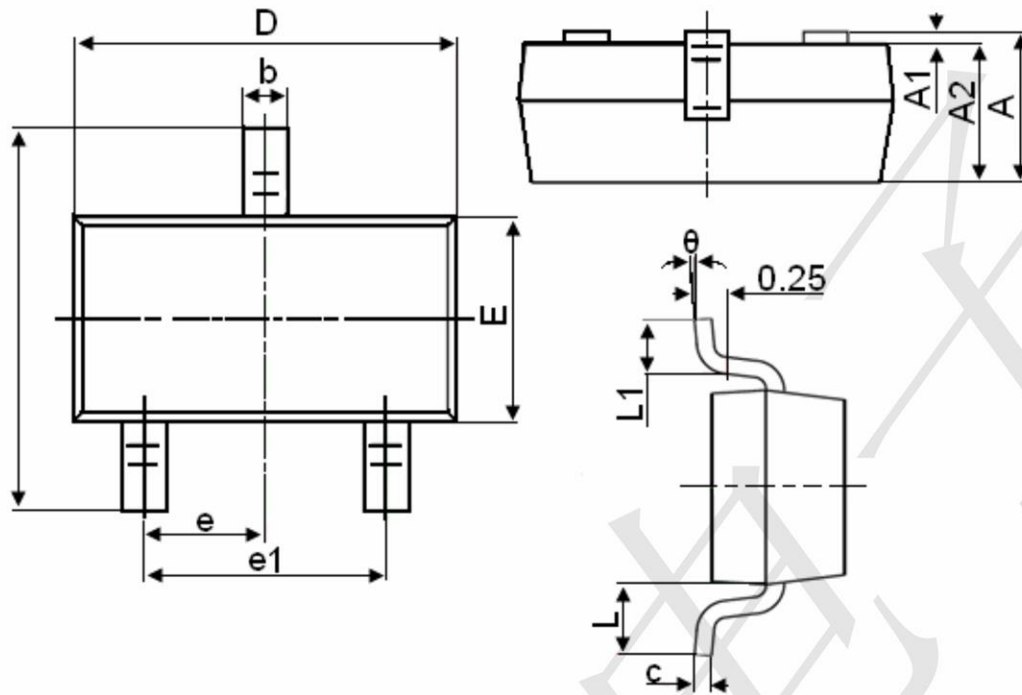

Figure 14 Normalized Maximum Transient Thermal Impedance



SOT-23 Package Information



Symbol	Dimensions in Millimeters	
	MIN.	MAX.
A	0.900	1.150
A1	0.000	0.100
A2	0.900	1.050
b	0.300	0.500
c	0.080	0.150
D	2.800	3.000
E	1.200	1.400
E1	2.250	2.550
e	0.950TYP	
e1	1.800	2.000
L	0.550REF	
L1	0.300	0.500
θ	0°	8°