

### General Description

The SY8105I is a high efficiency 500kHz synchronous step-down DC/DC regulator, which is capable of delivering up to 5A load current. It can operate over a wide input voltage range from 4.5V to 18V and integrates main switch and synchronous switch with very low  $R_{DS(ON)}$  to minimize the conduction loss.

The SY8105I adopts the instant PWM architecture to achieve fast transient responses for high step down applications and high efficiency at light loads. In addition, it operates at pseudo-constant frequency of 500kHz to minimize the size of inductor and capacitor.

### Ordering Information

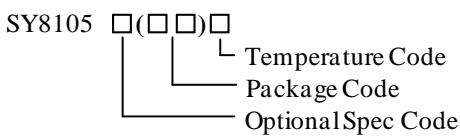

Ordering Number	Package type	Note
SY8105IADC	TSOT23-6	----

### Features

- Low  $R_{DS(ON)}$  for Internal Switches (Top/Bottom): 41mΩ/27mΩ
- 4.5-18V Input Voltage Range
- 5A Output Current Capability
- 500kHz Switching Frequency Minimize the External Components
- Stable with 22μF  $C_{OUT}$  and 0.68μH Inductor
- Instant PWM Architecture to Achieve Fast Transient Responses
- Internal Soft-Start Limits the Inrush Current
- Cycle-by-cycle Peak/Valley Current Limitation
- Hiccup Mode Output Short Circuit Protection
- Thermal Shutdown with Auto Recovery
- Output Auto Discharge Function
- Compact Package: TSOT23-6

### Applications

- Set Top Box
- Portable TV
- DSL Modem
- LCD TV
- IP CAM
- Networking

### Typical Applications

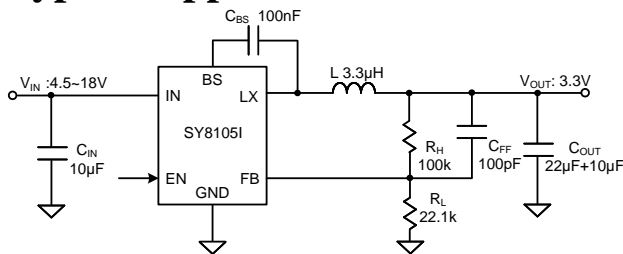

Figure1. Schematic Diagram

Inductor and  $C_{OUT}$  Selection Table

$V_{OUT}$ [V]	L [μH]	$C_{OUT}$ [μF]			
		10	22	22+10	2×22
1.2	0.68	✓	✓	✓	✓
	1.5	✓	☆	✓	✓
3.3	1.5	✓	✓	✓	✓
	3.3	✓	☆	✓	✓
5	2.2	✓	✓	✓	✓
	4.7	✓	☆	✓	✓

Note: '☆' means recommended for most applications.

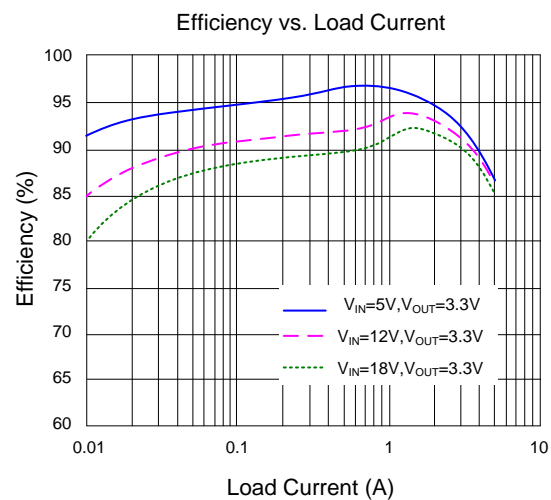
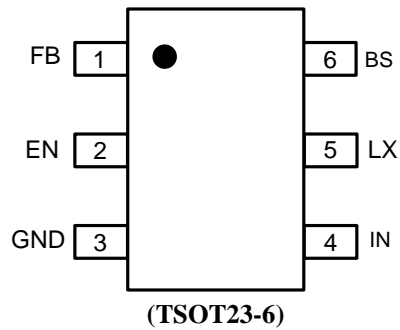

Figure2. Efficiency vs. Output Current

## Pinout (top view)



Top mark: **dMxyz** (Device code: dM, x=year code, y=week code, z=lot number code)

Pin Name	Pin Number	Pin Description
FB	1	Feedback pin. Connect this pin to the center point of the output resistor divider (as shown in Figure 1) to program the output voltage: $V_{OUT}=0.6 \times (1+R_H/R_L)$ .
EN	2	Enable control pin. Pull high to turn on. Do not leave it floating.
GND	3	Power ground pin.
IN	4	Input pin. Decouple this pin to GND pin with at least a 10 $\mu$ F ceramic capacitor.
LX	5	Inductor pin. Connect this pin to the switching node of inductor.
BS	6	Boot-strap pin. Supply high side gate driver. Connect a 0.1 $\mu$ F ceramic capacitor between BS and LX pin.

## Block Diagram

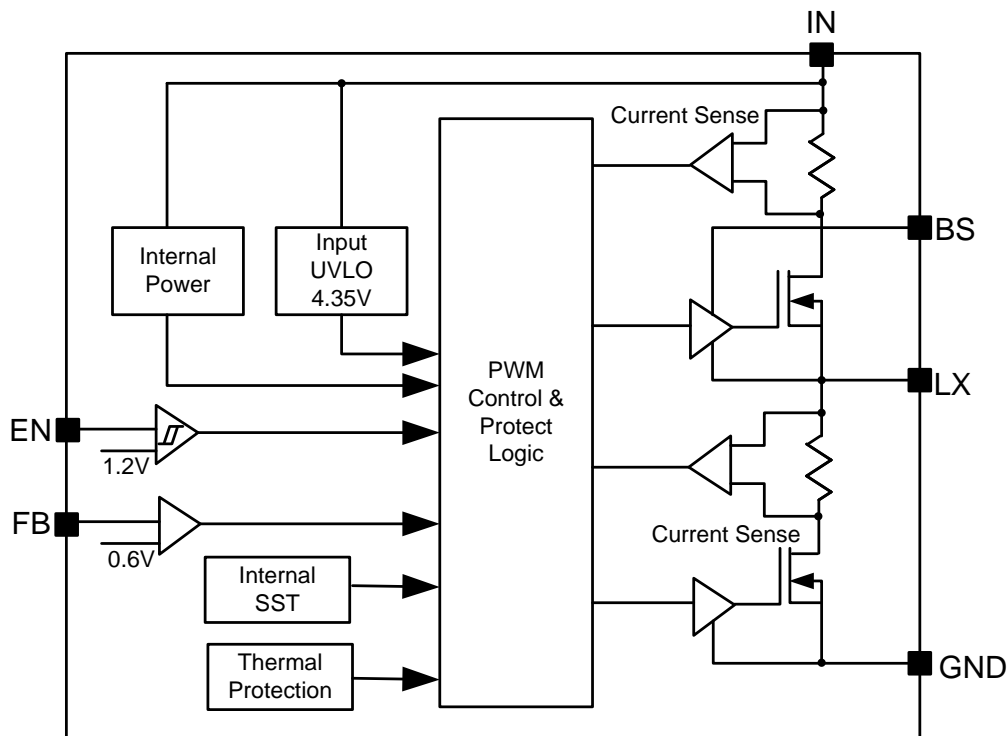

Figure3. Block Diagram



**Absolute Maximum Ratings** (Note 1)

Supply Input Voltage	-----	-0.3V to 19V
LX, EN Voltage	-----	-0.3V to $V_{IN} + 0.3V$
FB, BS-LX Voltage	-----	-0.3V to 4V
Power Dissipation, $P_D$ @ $T_A = 25^\circ C$ TSOT23-6,	-----	2.1W
Package Thermal Resistance (Note 2)		
$\theta_{JA}$	-----	46°C/W
$\theta_{JC}$	-----	6°C/W
Junction Temperature Range	-----	-40°C to 150°C
Lead Temperature (Soldering, 10 sec.)	-----	260°C
Storage Temperature Range	-----	-65°C to 150°C
Dynamic LX Voltage in 10ns Duration (Note3)	-----	IN+3V to GND-5V

**Recommended Operating Conditions** (Note 3)

Supply Input Voltage	-----	4.5V to 18V
Junction Temperature Range	-----	-40°C to 125°C
Ambient Temperature Range	-----	-40°C to 85°C



## Electrical Characteristics

( $V_{IN} = 12V$ ,  $V_{OUT} = 3.3V$ ,  $L = 3.3\mu H$ ,  $C_{OUT} = 22\mu F + 10\mu F$ ,  $T_A = 25^\circ C$ ,  $I_{OUT} = 1A$  unless otherwise specified)

Parameter	Symbol	Test Conditions	Min	Typ	Max	Unit
Input Voltage Range	$V_{IN}$		4.5		18	V
Input UVLO Threshold	$V_{UVLO}$				4.35	V
Input UVLO Hysteresis	$V_{HYS}$			0.5		V
Quiescent Current	$I_Q$	$I_{OUT}=0$ , $V_{FB}=V_{REF}\times 105\%$		250		$\mu A$
Shutdown Current	$I_{SHDN}$	EN=0		5	10	$\mu A$
Feedback Reference Voltage	$V_{REF}$		591	600	609	mV
FB Input Current	$I_{FB}$	$V_{FB}=3.3V$	-50		50	nA
Output Discharge Resistance	$R_{DIS}$			50		$\Omega$
Top FET $R_{ON}$	$R_{DS(ON)1}$			41		m $\Omega$
Bottom FET $R_{ON}$	$R_{DS(ON)2}$			27		m $\Omega$
EN Rising Threshold	$V_{EN,R}$		1.08	1.2	1.32	V
EN Falling Threshold	$V_{EN,F}$		0.9	1.0	1.1	V
Min ON Time	$t_{ON,MIN}$			50		ns
Min OFF Time	$t_{OFF,MIN}$			100		ns
Turn On Delay	$t_{ON,DLY}$	from EN high to LX start switching		0.5		ms
Soft-start Time	$t_{SS}$	$V_{OUT}$ from 0 to 100%		1.7		ms
Switching Frequency	$F_{SW}$	$V_{OUT}=3.3V$ , CCM		500		kHz
Top FET Current Limit	$I_{LIM, TOP}$		7			A
Bottom FET Current Limit	$I_{LIM, BOT}$		5			A
Output Under Voltage Protection Threshold	$V_{UVP}$			0.33		$V_{REF}$
Output UVP Delay	$t_{UVP, DLY}$			100		$\mu s$
UVP Hiccup On Time	$t_{UVP, ON}$			2.5		ms
UVP Hiccup Off Time	$t_{UVP, OFF}$			9		ms
Thermal Shutdown Temperature	$T_{SD}$			150		$^\circ C$
Thermal Shutdown Hysteresis	$T_{HYS}$			15		$^\circ C$

**Note 1:** Stresses beyond the “Absolute Maximum Ratings” may cause permanent damage to the device. These are stress ratings only. Functional operation of the device at these or any other conditions beyond those indicated in the operational sections of the specification is not implied. Exposure to absolute maximum rating conditions for extended periods may affect device reliability.

**Note 2:**  $\theta_{JA}$  is measured in the natural convection at  $T_A = 25^\circ C$  on a 2OZ four-layer Silergy evaluation board. Paddle of TSOT23-6 package is the case position for SY8105I  $\theta_{JC}$  measurement.

**Note 3:** The device is not guaranteed to function outside its operating conditions.

**TSOT23-6 Package Outline & PCB Layout**

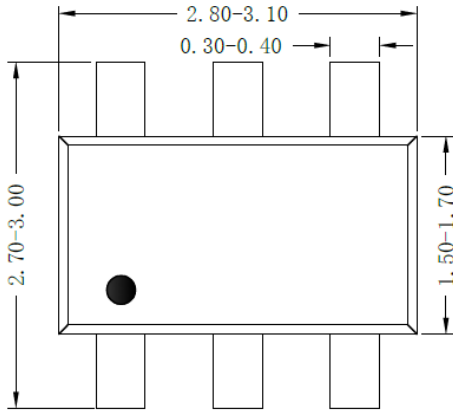

**Top view**

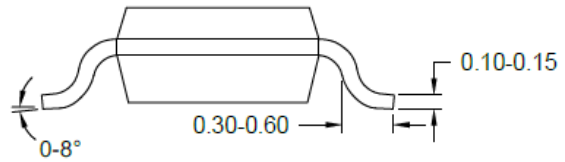

**Side view**

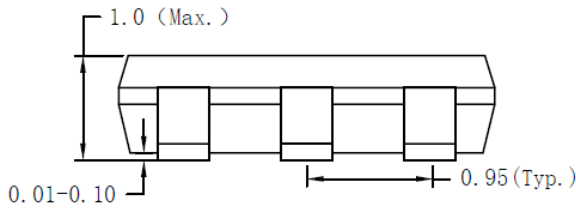

**Front view**

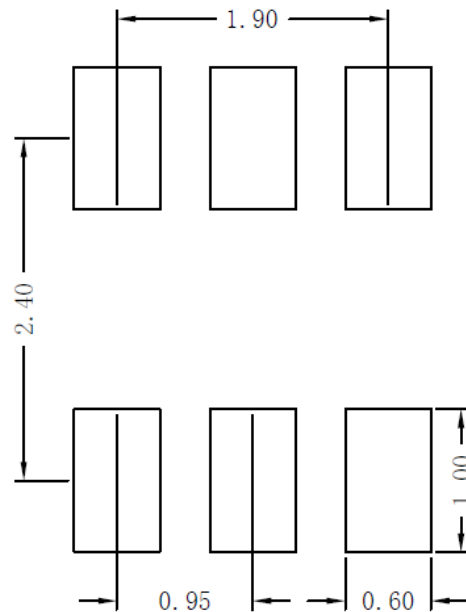

**Recommended Pad Layout**

**Notes: All dimension in millimeter and exclude mold flash & metal burr.**

## Taping & Reel Specification

### 1. Taping orientation

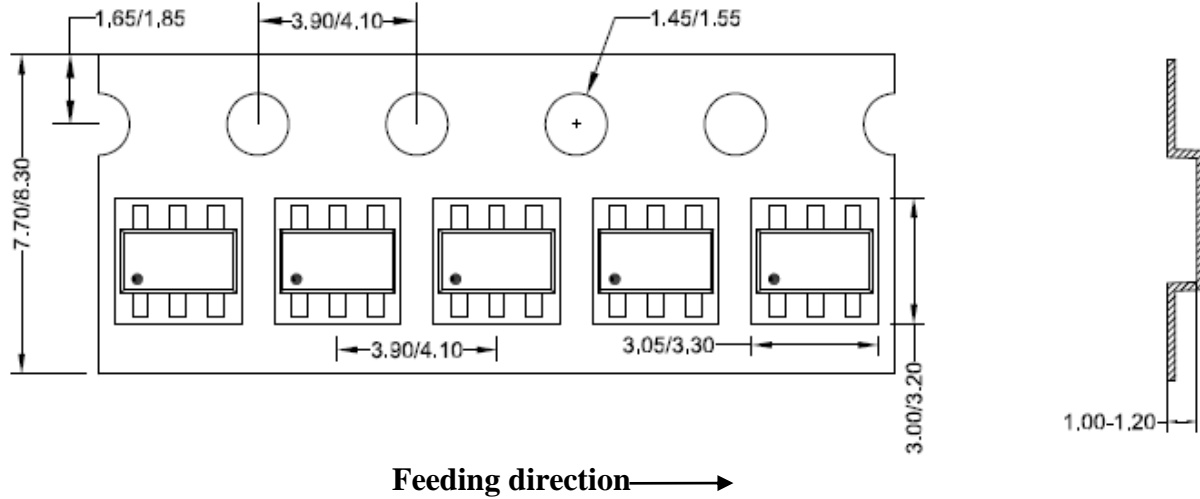

### 2. Carrier Tape & Reel specification for packages

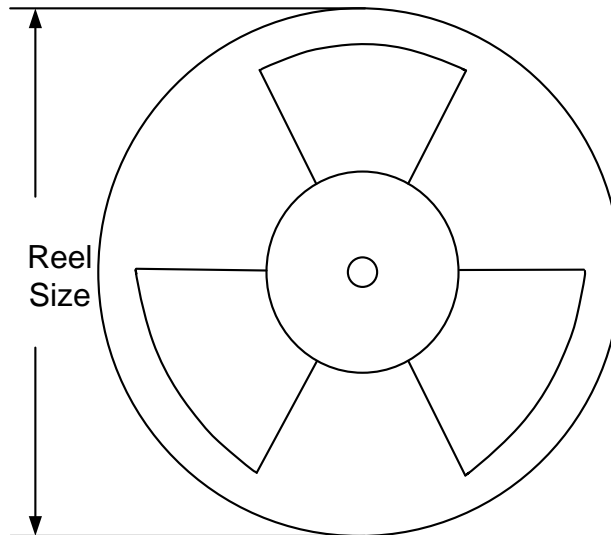

Package types	Tape width (mm)	Pocket pitch(mm)	Reel size (Inch)	Trailer length(mm)	Leader length (mm)	Qty per reel
TSOT23-6	8	4	7	400	160	3000

### 3. Others: NA