



LIGHT EMITTING DIODE SPECIFICATION

CUSTOMER NAME:

DESCRIPTION: E6X0602CWAY1UDA

REVISION: V2.2

ISSUE DATE: 2022-03-25

Contains trade secret information which is the property of Ekinglux and shall not be made available to, or copied or used by anyone outside Ekinglux without its written authorization. Copyright © 2017 Ekinglux Optoelectronics Technology Co., Ltd. All rights reserved

Features:

- Long operating life
- Low Power Consumption
- Wide Viewing Angle
- Low voltage DC operated
- RoHS Compliant

Application:

- 3C product
- side view backlight
- Status indicator
- smart appliances
- Wearable and portable devices

Part Number	Dice Material	Emitted Color	Lens Color
E6X0602CWAY1UDA	InGaN	White	Yellow Diffused

Electro-Optical Characteristics (T_a=25°C, @20mA)

Parameter	Symbol	Min.	Typ.	Max.	Unit
Luminous Intensity	IV	400	600	800	mcd
Radiation Bandwidth	Δλ	-	-	-	nm
Forward Voltage	V _F	2.90	3.0	3.40	v
Luminous Flux	Φ	-	-	-	Lm
Dominant Wavelength	λ _d	-	-	-	nm
CIE Coordinates CIE	x,y	Please refer to Color Bin Limits			
Color Temperature	T _c	-	-	-	k
Viewing Angle	2θ _{1/2}	-	120	-	deg
Reverse Current	I _R	-	-	10	uA

Absolute Maximum Ratings (T_a=25°C)

Parameter	Symbol	Max.	Unit
Power Dissipation	P _d	85	mW
Peak Forward Current(1/10 Duty Cycle, 0.1ms Pulse Width)	I _{FP}	100	mA
Forward Current	I _F	25	mA
Reverse Voltage	V _R	5	v
Electrostatic Discharge	ESD	2000	v
Operating Temperature Range	T _{opr}	-40to+85	°C
Storage Temperature Range	T _{stg}	-40to+90	°C
Reflow Soldering	T _{sld}	260°C for 10secs	



Optical & Electrical Characteristics

Spectrum

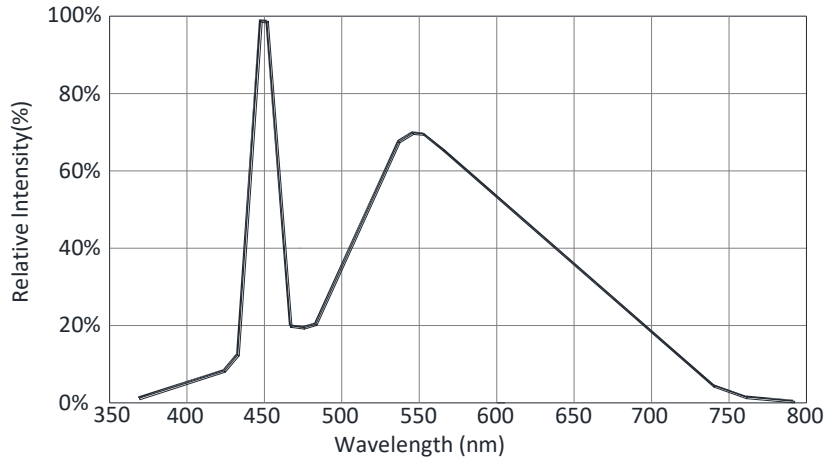

Forward Current vs. Forward Voltage

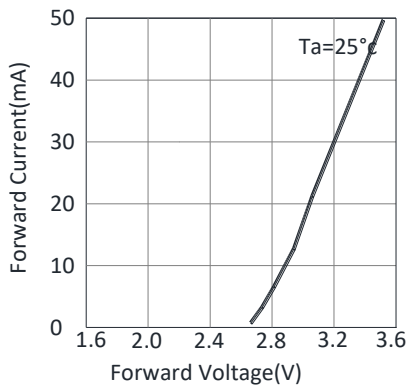

Maximum Driving Forward DC Current vs. Ambient Temperature (De-rating based on Tj max.=115°C)

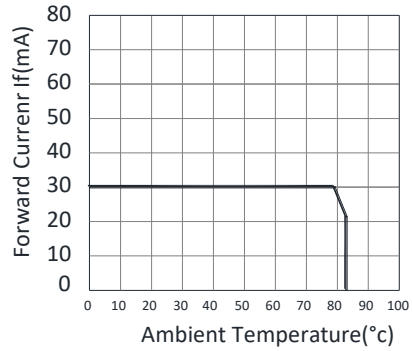

Relative Intensity vs. Forward Current

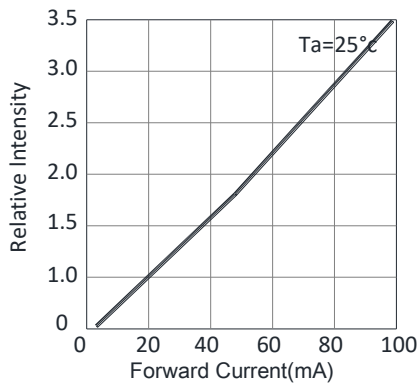

Relative Intensity vs. Ambient Temperature

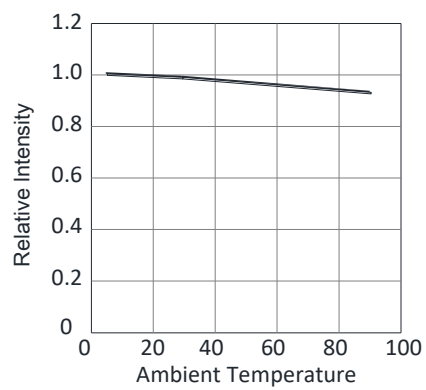

Radiation Pattern

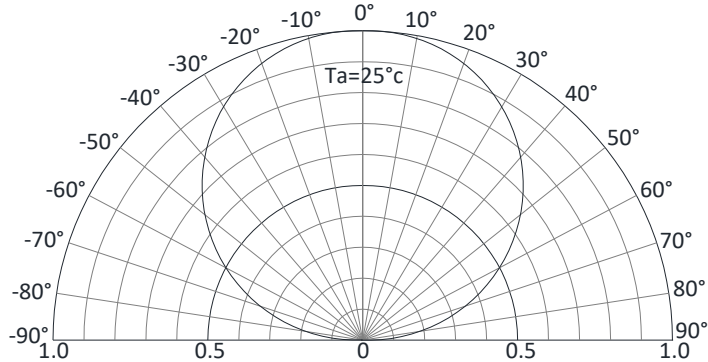



Bin Limits

Bin Range Of Luminous Intensity (Unit:mcd)

Bin Code	Min	Max	Condition
L1	400	600	IF=20mA
L2	600	800	
L3	-	-	

Bin Range Of Forward Voltage (Unit:V)

Bin Code	Min	Max	Condition
V1	2.9	3.0	IF=20mA
V2	3.0	3.1	
V3	3.0	3.2	
V4	3.2	3.3	
V5	3.3	3.4	

Notes:

- 1.Tolerance of Luminous Intensity $\pm 10\%$
- 2.Tolerance of Forward Voltage $\pm 0.1V$



Color Bin Limits

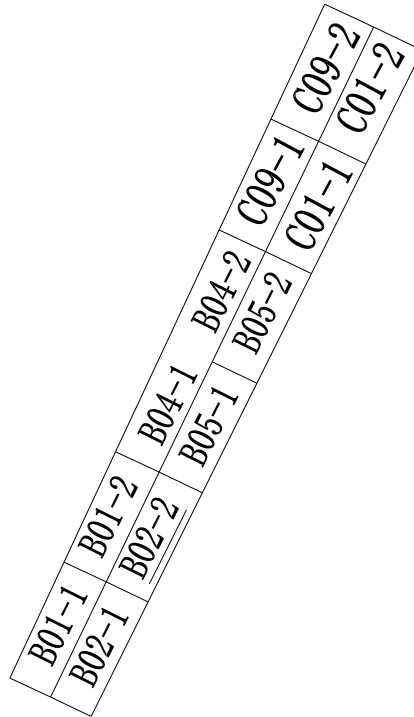

BIN	X1	Y1	X2	Y2	X3	Y3	X4	Y4
B01-1	0.2699	0.2697	0.2668	0.2711	0.2709	0.2798	0.2740	0.2783
B01-2	0.2740	0.2783	0.2709	0.2798	0.2747	0.2881	0.2780	0.2866
B02-1	0.2729	0.2682	0.2699	0.2697	0.2740	0.2783	0.2772	0.2768
B02-2	0.2772	0.2768	0.2740	0.2783	0.2780	0.2866	0.2812	0.2850
B04-1	0.2780	0.2866	0.2747	0.2881	0.2786	0.2964	0.2820	0.2948
B04-2	0.2820	0.2948	0.2786	0.2964	0.2825	0.3047	0.2860	0.3031
B05-1	0.2812	0.2850	0.2780	0.2866	0.2820	0.2948	0.2853	0.2932
B05-2	0.2853	0.2932	0.2820	0.2948	0.2860	0.3031	0.2894	0.3015
C01-1	0.2894	0.3015	0.2860	0.3031	0.2899	0.3114	0.2935	0.3097
C01-2	0.2935	0.3097	0.2899	0.3114	0.2941	0.3200	0.2977	0.3182
C09-1	0.2860	0.3031	0.2825	0.3047	0.2864	0.3130	0.2899	0.3114
C09-2	0.2899	0.3114	0.2864	0.3130	0.2904	0.3217	0.2941	0.3200

**Reliability Test Items And Conditions**

Test Items	Reference	Test Conditions	Time	Quantity	Criterion
Thermal Shock	MIL-STD-202G	-40℃ (30min) -100℃ (30min)	100 Cycles	22	0/22
Temperature And Humidity Cyclic	JEITA ED-4701 200 203	-10℃~65℃ ; 0%~90%RH	10cycles	22	0/22
High Temperature Storage	JEITA ED -4071 200 201	Ta=100℃	1000H	22	0/22
Low Temperature Storage	JEITA ED -4071 200 202	Ta=-40℃	1000H	22	0/22
High Temperature High Humidity Storage	JEITA ED -4071 100 103	Ta=60℃ ; RH=90%	1000H	22	0/22
High Temperature Life Test	JESD22-A108D	Ta=80℃	1000H	22	0/22
Life Test	JESD22-A108D	Ta=25℃ IF=20mA	1000H	22	0/22
Resistance to Sodering Heat	GB/T 4937, II , 2.2&2.3	Tsol*=(240±5) ℃10secs	2 times	22	0/22

Criteria For Judging Damage

Test Items	Symbol	Test Conditions	Criteria For Judging Damage
Forward Voltage	V _F	I _F =I _{FT}	Initial Data±10%
Recerse Current	I _R	V _R =5V	I _R ≤10uA
Luminous Intensity	I _V	I _F =I _{FT}	Average I _V degradation≤30% ; Single LED I _V degradation≤50%
Resistance to Soldering Heat	-	-	Material without internal cracks,no material between stripped,no deaded light

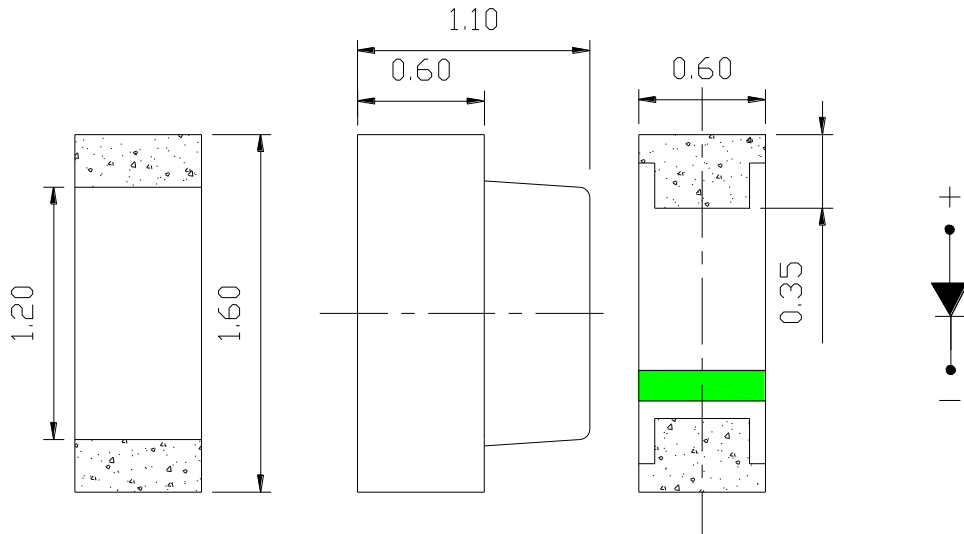
Product size (Unit:mm)

NOTES :

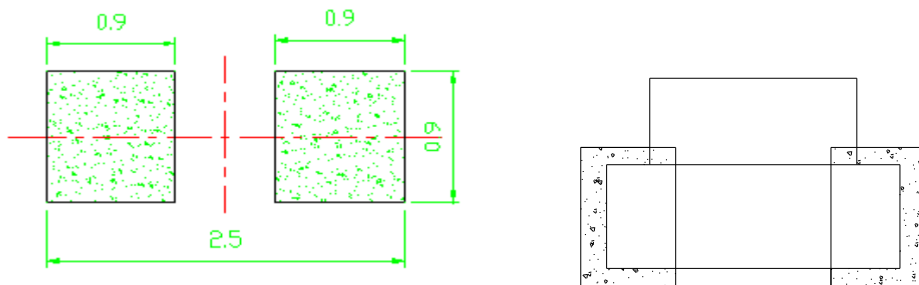
1. All dimensions are in millimeters (inches)
2. Tolerances are $\pm 0.2\text{mm}$ (0.008inch) unless otherwise noted

Recommended Soldering Pad Design (Unit:mm)

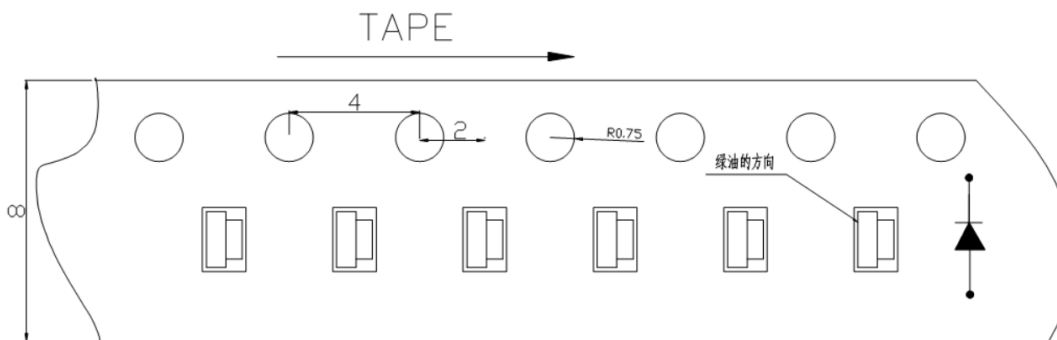
Taping and package Spec

- Tape Specification:4,000pcs Per Reel



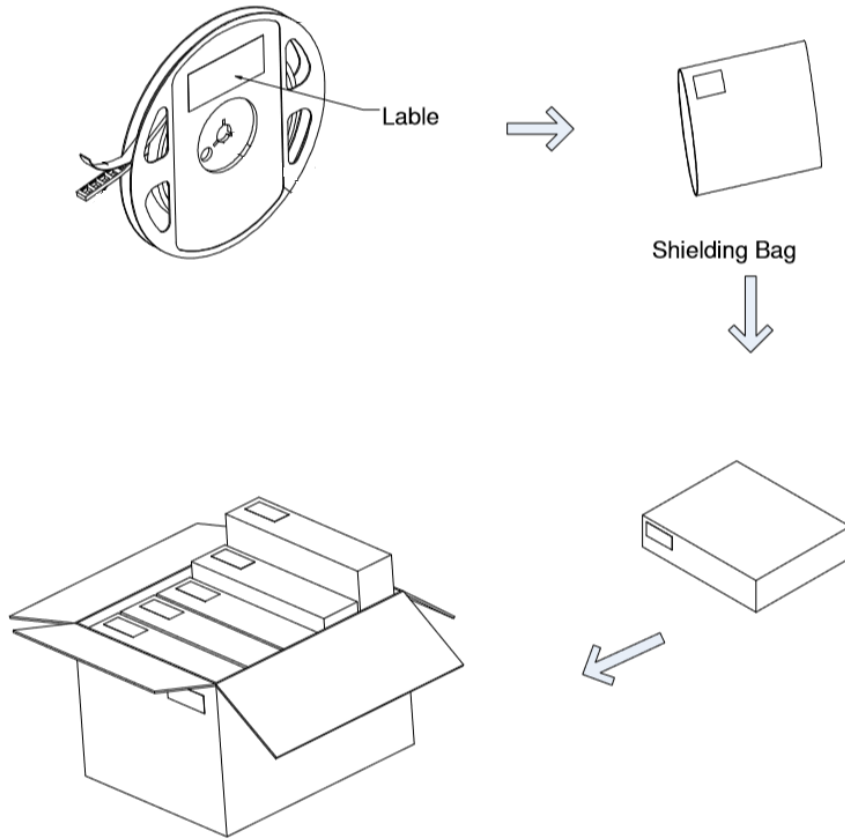

Packaging



LabelStyle

EKINGLUX OPTOELECTRONICS(SHANGHAI) CO.,LTD
 TEL:86 21 59909181 Sales@ekingluxs.com

P/N:XXXXXXXXXXXXXXXXXX

Emitting Color: XXXX
 HUE: XXX-XXX nm
 IV : XXX-XXX mcd **example**
 VF: XX-XX V
 QTY: XX PCS

RoHS COMPLIANT **Pb-Free**

BIN Code: XX
 DATE: XXXX/XX/XX

LOT NO.:XXXXXXX



Table of Classification Reflow Profiles

Profile Feature	Sn-Pb Eutectic Assembly	Pb-Free Assembly
Preheat & Soak	100 °C	150 °C
Temperature min (T _{min})	150°C	200 °C
Temperature max (T _{max})	60-120 seconds	60-120 seconds
Time (T _{min} to T _{max}) (t _s)		
Average ramp-up rate (T _{max} to T _p)	3 °C/second max	3 °C/second max
Liquidous temperature (T _L)	183 °C	217 °C
Time at liquidous (t _L)	60-150 seconds	60-150 seconds
Peak package body temperature (T _p)*	230 °C ~235 °C	255 °C ~260 °C
Classification temperature (T _c)	235 °C	260 °C
Time (t _p) within 5 °C of the specified Classification temperature (T _c)	20 seconds	30 seconds
Average ramp-down rate (T _p to T _{max})	6 °C/second max	6 °C/second max
Time 25 °C to peak temperature	6 minutes max	8 minutes max

1. Tolerance for peak profile temperature (T_p) is defined as a supplier minimum and a user maximum.
2. Tolerance for time at peak profile temperature (t_p) is defined as a supplier minimum and a user maximum.

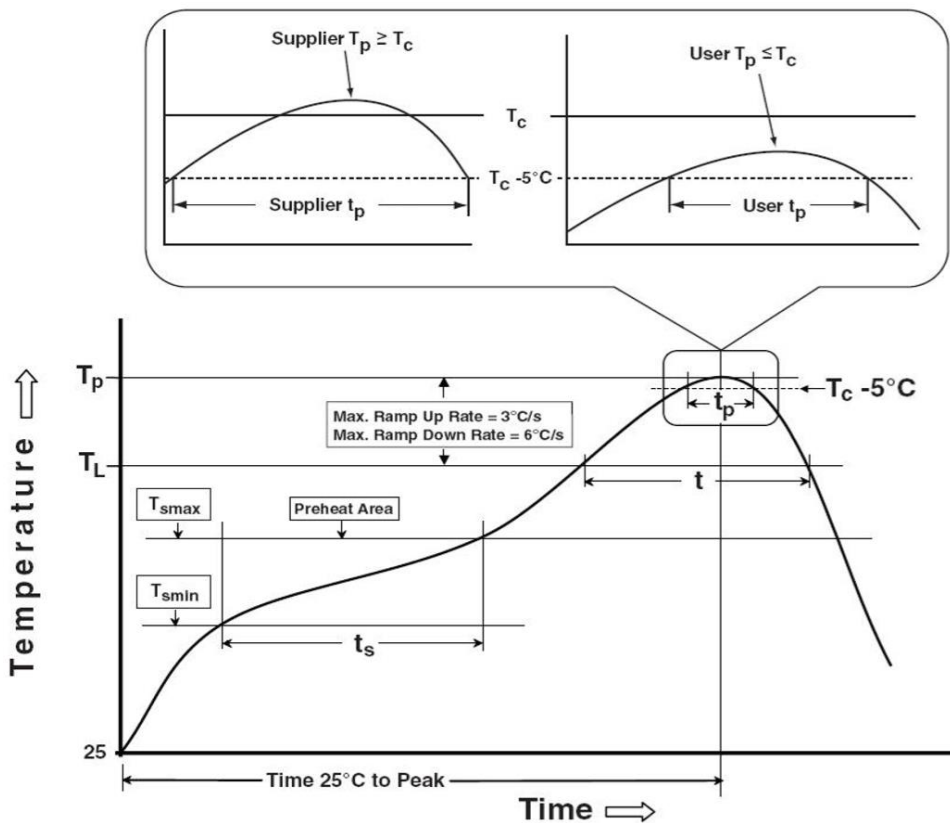



Precautions

1. Storage:

- Moisture proof and anti-electrostatic package with moisture absorbent material is used, to keep moisture to a minimum.
- Before opening the package, the product should be kept at 30°C or less and humidity less than 60% RH, and be used within a year.
- After opening the package, the product should be stored at 30°C or less and humidity less than 10%RH. It is recommended that the product be operated at the workshop condition of 30°C or less and humidity less than 60%RH.
- If the moisture absorbent material has faded away or the LEDs have exceeded the storage time, baking treatment should be performed based on the following condition: (70±5)°C for 24 hours.

2. Static Electricity:

Static electricity or surge voltage damages the LEDs. Damaged LEDs will show some unusual characteristics such as the forward voltage becoming lower, or the LEDs do not light at the low current, even not light.

All devices, equipment and machinery must be properly grounded. At the same time, it is recommended that wrist bands or anti-electrostatic gloves, anti-electrostatic containers be used when dealing with the LEDs.

3. Vulcanization:

LED curing is due to sulfur being in brackets and the +1 price of silver in the chemical reaction generated Ag₂S in the process. It will lead to the capacity of reflecting of silver layer reducing, light color temperature drift and serious decline, seriously affecting the performance of the product. So we should take corresponding measures to avoid vulcanization, such as to avoid using sulphur volatile substances and keeping away from high sulphur content of the material.