

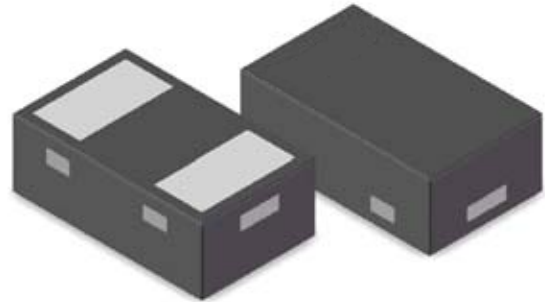

### Features

- 80Watts peak pulse power ( $t_p = 8/20\mu s$ )
- Tiny DFN0603 package
- Bidirectional configurations
- Solid-state silicon-avalanche technology
- Low clamping voltage
- Low leakage current
- IEC 61000-4-2  $\pm 30kV$  contact  $\pm 30kV$  air
- IEC 61000-4-4 (EFT) 40A (5/50ns)
- IEC 61000-4-5 (Lightning) 8A (8/20 $\mu s$ )



### Applications

- Cell Phone Handsets and Accessories
- Microprocessor based equipment
- Personal Digital Assistants (PDA's)
- Notebooks, Desktops, and Servers
- Portable Instrumentation

### Mechanical Data

- DFN0603 package
- Molding compound flammability rating: UL 94V-0
- Packaging: Tape and Reel
- RoHS/WEEE Compliant

### Schematic & PIN Configuration

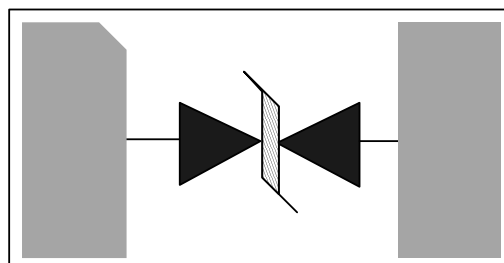

DFN0603

**Absolute Maximum Rating**

Rating	Symbol	Value	Units
Peak Pulse Power ( $t_p = 8/20\mu s$ )	$P_{PP}$	80	Watts
Peak Pulse Current ( $t_p = 8/20\mu s$ ) (note1)	$I_{PP}$	8	A
ESD per IEC 61000-4-2 (Air) ESD per IEC 61000-4-2 (Contact)	$V_{ESD}$	30 30	kV
Lead Soldering Temperature	$T_L$	260(10seconds)	°C
Junction Temperature	$T_j$	-55 to + 125	°C
Storage Temperature	$T_{stg}$	-55 to + 125	°C

**Electrical Characteristics**

Parameter	Symbol	Conditions	Min	Typical	Max	Units
Reverse Stand-Off Voltage	$V_{RWM}$				5.0	V
Reverse Breakdown Voltage	$V_{BR}$	$I_T = 1mA$	6.5			V
Reverse Leakage Current	$I_R$	$V_{RWM} = 5V, T = 25^\circ C$		0.1	0.5	$\mu A$
Peak Pulse Current	$I_{PP}$	$t_p = 8/20\mu s$		8		A
Clamping Voltage	$V_C$	$I_{PP} = 8A, t_p = 8/20\mu s$		10		V
Junction Capacitance	$C_j$	$V_R = 0V, f = 1MHz$		17		pF

**Electrical Parameters (TA = 25 °C unless otherwise noted)**

Symbol	Parameter
$I_{PP}$	Maximum Reverse Peak Pulse Current
$V_C$	Clamping Voltage @ $I_{PP}$
$V_{RWM}$	Working Peak Reverse Voltage
$I_R$	Maximum Reverse Leakage Current @ $V_{RWM}$
$V_{BR}$	Breakdown Voltage @ $I_T$
$I_T$	Test Current

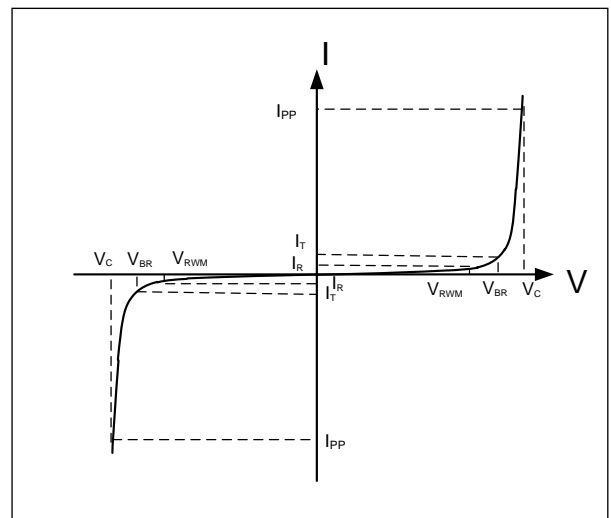

Note.: 8/20 $\mu s$  pulse waveform.

## Typical Characteristics

Figure 1: Peak Pulse Power vs. Pulse Time

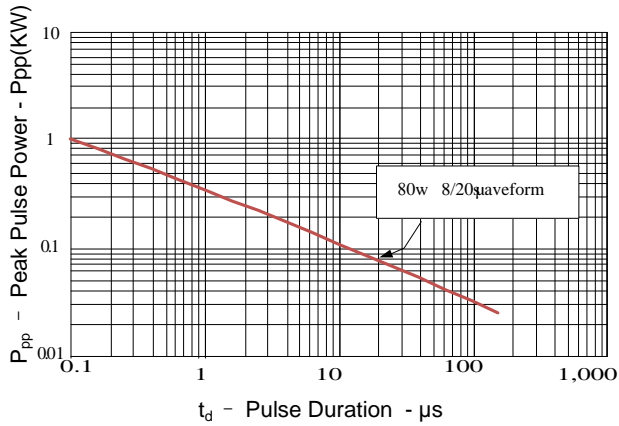

Figure 2: Power Derating Curve

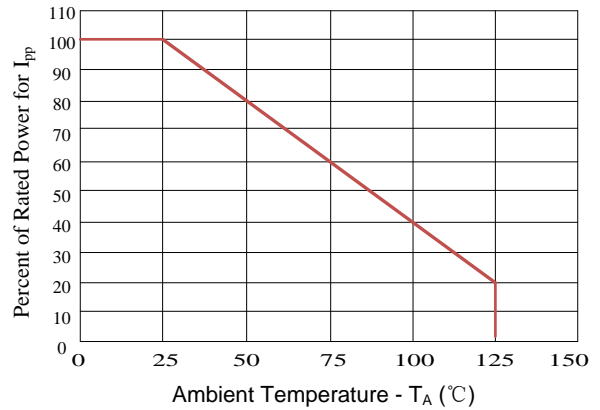

Figure3: Pulse Waveform

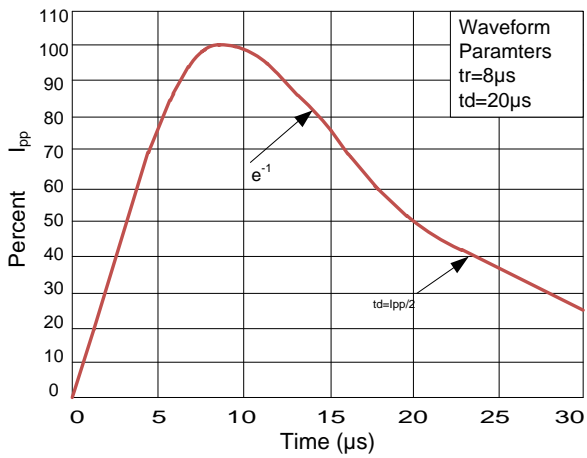
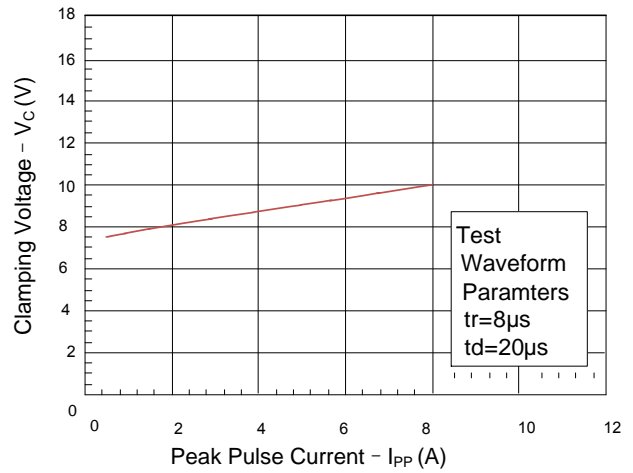
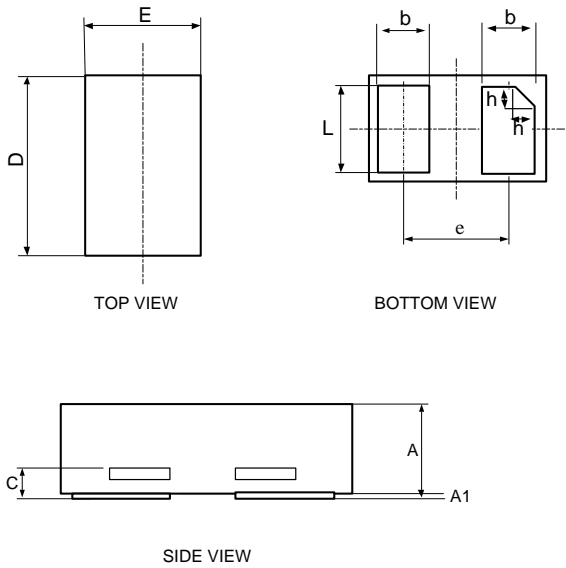

Figure 4: Clamping Voltage vs. I<sub>pp</sub>



Outline Drawing – DFN0603



Symbol	Dimensions in millimeters		
	Min	Nom	Max
A	0.28	0.30	0.34
A1	0.00	0.02	0.05
C	0.05	0.10	0.15
D	0.55	0.60	0.65
E	0.25	0.30	0.35
e	0.40		
b	0.13	0.19	0.24
L	0.20	0.25	0.30
h	0	0.05	0.10

Marking



Ordering information

Order code	Package	Base qty	Delivery mode
LKE05NS-B	DFN0603	10k	Tape and reel