

### Features

- 2 $\mu$ A Ground Current at no Load
- $\pm 2\%$  Output Accuracy
- 200mA Output Current
- Wide Operating Input Voltage Range: 2V to 36V
- Dropout Voltage: 0.65V at 100mA ( $V_{OUT}=5V$ )
- Support Fixed Output Voltage 1.8V, 3.3V, 5V, 9V, 12V
- Stable with Ceramic or Tantalum Capacitor
- Current Limit Protection
- Over-Temperature Protection
- SOT-23-5 Package Available

### Applications

- Portable, Battery Powered Equipment
- Low Power Microcontrollers
- Laptop, Palmtops and PDAs
- Wireless Communication Equipment
- Audio/Video Equipment
- Car Navigation Systems
- Industrial Controls
- Weighting Scales
- Meters
- Home Automation

### General Description

The TP2202 is a low-dropout (LDO) voltage regulators with enable function offering the benefits of high input voltage, low-dropout voltage, low-power consumption, and miniaturized packaging.

The features of low quiescent current as low as 2 $\mu$ A and zero disable current is ideal for powering the battery equipment to a longer service life. The TP2202

is stable with the ceramic output capacitor over its wide input range from 2V to 36V and the entire range of output load current.

### Ordering Information

**TP2202-3.3YN5G**

YN5:SOT23-5 Package

Output voltage: 3.3=3.3V  
5.0=5.0V

### Marking

**TP2202-3.3YN5G Marking:  $\nabla$  H33**

## PIN CONFIGURATION

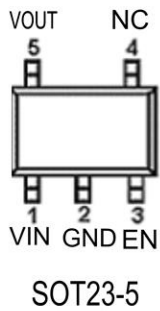

Pin No	Pin Name	Pin Function
1	VIN	Input of Supply Voltage.
2	GND	Ground
3	EN	Enable Control Input.
4	NC	No Internal Connection.
5	VOUT	Output of the Regulator

## Typical Application Circuit

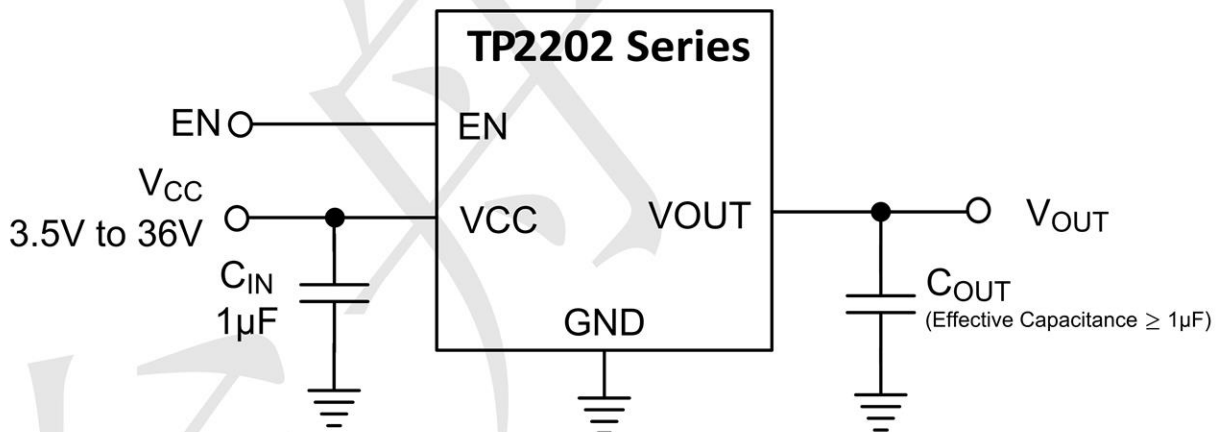
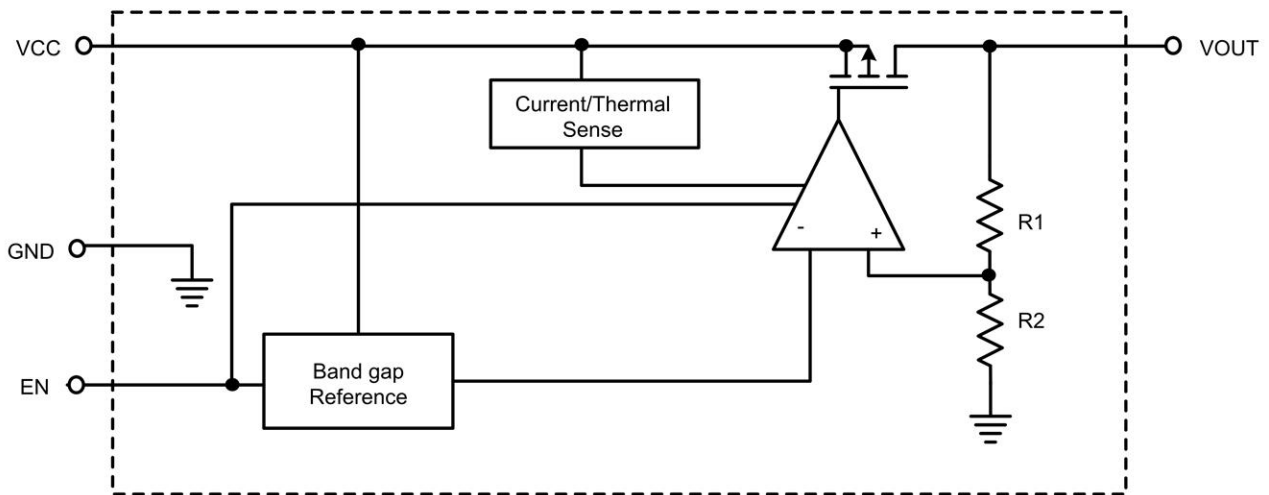

Figure 1: Application circuit of Fixed  $V_{OUT}$  LDO with enable and sense functions

**BLOCK DIAGRAM**



**Absolute Maximum Ratings**

VIN Pin to GND Pin Voltage .....	-0.3V to 40V
VOUT Pin to GND Pin Voltage 9V 12V .....	-0.3V to 14V
1.8V 3.3V 5.0V .....	-0.3V to 6.0V
VOUT Pin to VIN Pin Voltage .....	-40V to 0.3V
Storage Temperature Range .....	-60°C~150°C
Lead Temperature (Soldering, 10 sec) .....	260°C
Junction Temperature .....	150°C
Operating Ambient Temperature Range $T_A$ .....	-40°C~85°C
SOT-23-5, $\theta_{JA}$ .....	218.1°C/W
SOT-23-5, $\theta_{JC}$ .....	28.5°C/W

(Assume no Ambient Airflow, no Heatsink)

**Recommended Operating Conditions**

Supply Input Voltage .....	-3.5V to 36V
Junction Temperature Range .....	-40°C to 125°C
Ambient Temperature Range .....	-40°C to 85°C

### Electrical Characteristics

( $V_{IN}=15V$ ,  $V_{EN}=5V$ ,  $T_A=25^{\circ}C$ , unless otherwise specified) (Note 1)

Parameter	Symbol	Test Conditions	Min	Typ	Max	Unit
Supply Voltage	$V_{IN}$		2	--	36	V
DC Output Voltage Accuracy		$I_{LOAD} = 0.1mA$	-2		2	%
Dropout Voltage ( $I_{LOAD} = 100mA$ )	$V_{DROP}$	$V_{OUT} \geq 5V$	--	0.66		V
	$V_{DROP\_3.3V}$	$V_{OUT} = 3.3V$		0.75		
	$V_{DROP\_1.8V}$	$V_{OUT} = 1.8V$		1		
Ground Current ( $I_{LOAD} = 0mA$ )	$I_Q$	$V_{OUT} \leq 5V$		2		$\mu A$
	$I_{QH}$	$5V < V_{OUT} \leq 12V$		4.5		
Shutdown Ground Current	$I_{SD}$	$V_{EN} = 0V$ , $V_{OUT} = 0V$		0.01	0.5	$\mu A$
$V_{OUT}$ Shutdown Leakage Current	$I_{LEAK}$			0.01	0.5	$\mu A$
Enable Threshold Voltage	$V_{IH}$	EN Rising			2	V
	$V_{IL}$	EN Falling	0.6			
EN Input Current	$I_{EN}$	$V_{EN} = 36V$		10	100	nA
Line Regulation	$\Delta LINE$	$I_{LOAD} = 1mA$ , $5 \leq V_{IN} \leq 36V$	--	0.3		%
Load Regulation	$\Delta LOAD$	$1mA \leq I_{LOAD} \leq 0.2A$		0.1		%
Output Current Limit	$I_{LIM}$	$V_{OUT} = 0$	200	300		mA
Power Supply Rejection Ratio	PSRR	$V_{OUT} = 5V$ , $I_{LOAD} = 1mA$ , $V_{IN} = 12V$ , $f = 100Hz$		70		dB
Thermal Shutdown Temperature	$T_{SD}$	$I_{LOAD} = 10mA$	--	160	--	$^{\circ}C$
Thermal Shutdown Hysteresis	$\Delta T_{SD}$			15		$^{\circ}C$

**Note 1.** Specifications are production tested at  $T_A=25^{\circ}C$ . Specifications over the  $-40^{\circ}C$  to  $85^{\circ}C$  operating temperature range are assured by design, characterization and correlation with Statistical Quality Controls (SQC).



**Typical Operating Characteristics**

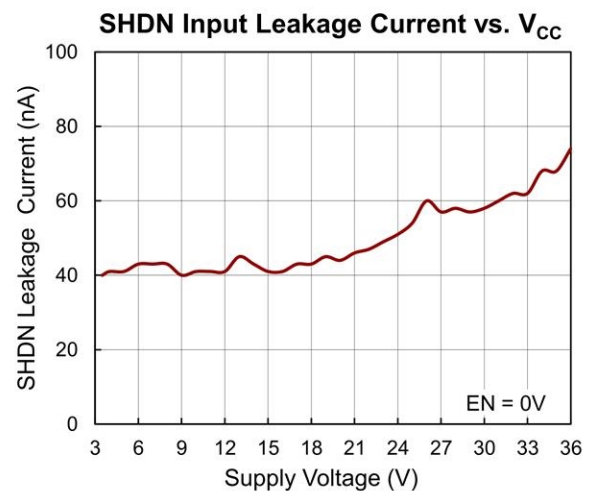
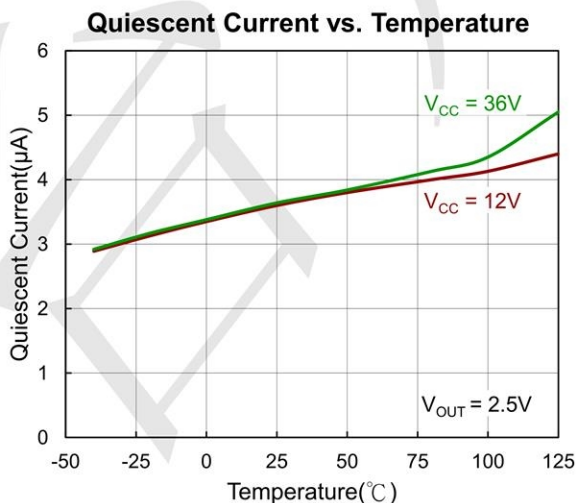
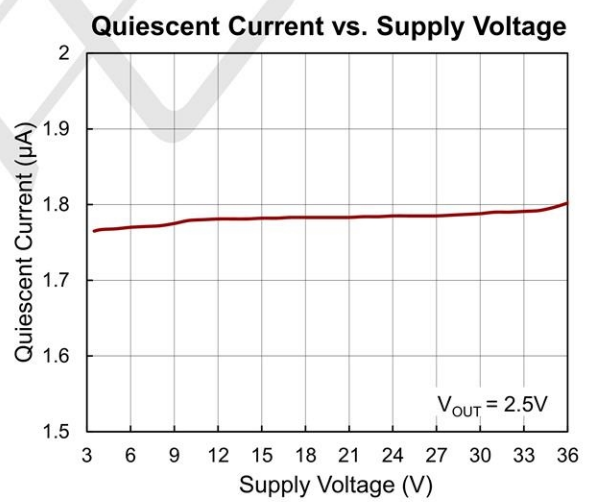
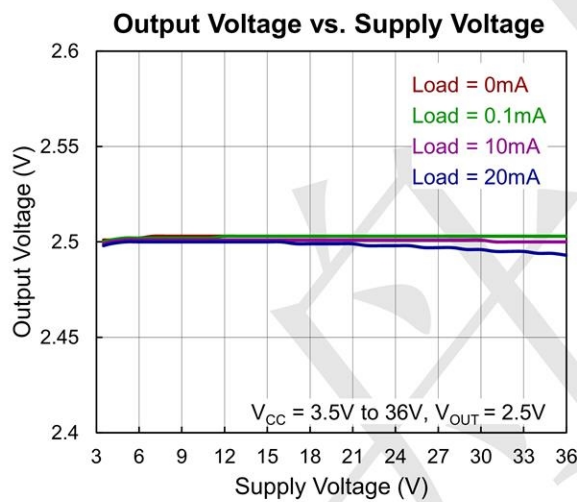
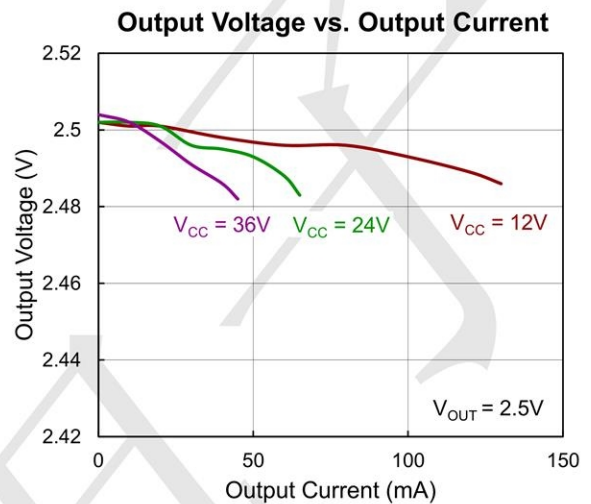
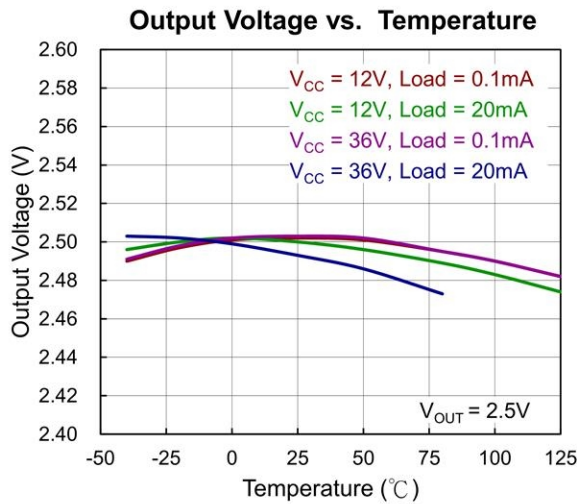



SHDN Leakage Input Current vs. Temp.

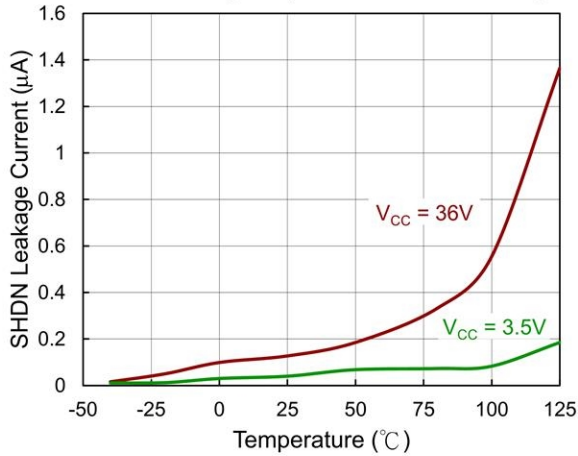

Enable Threshold vs. Supply Voltage

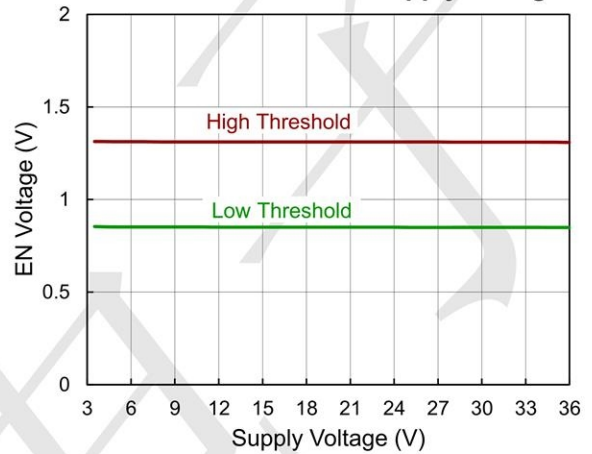

Enable Threshold vs. Temperature

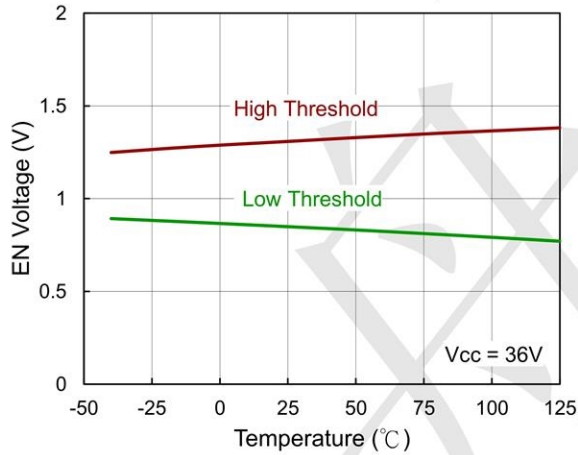

Dropout Voltage vs. Temperature

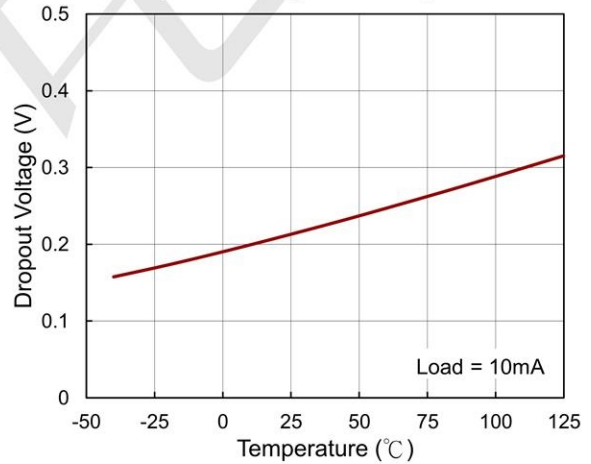

Current Limit vs. Temperature

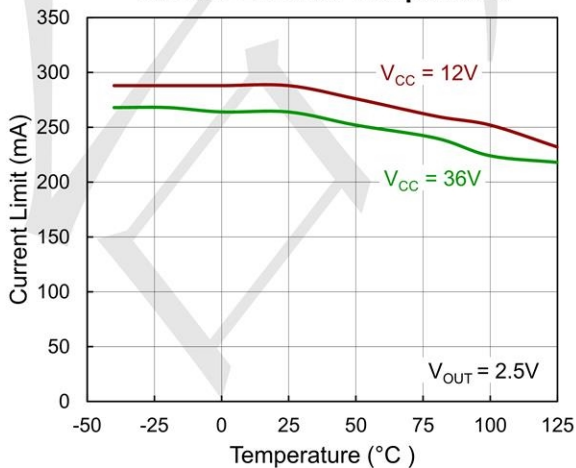

PSRR vs. Frequency

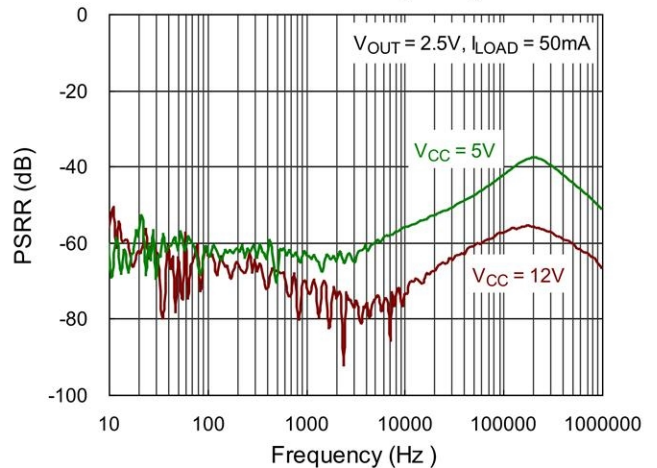

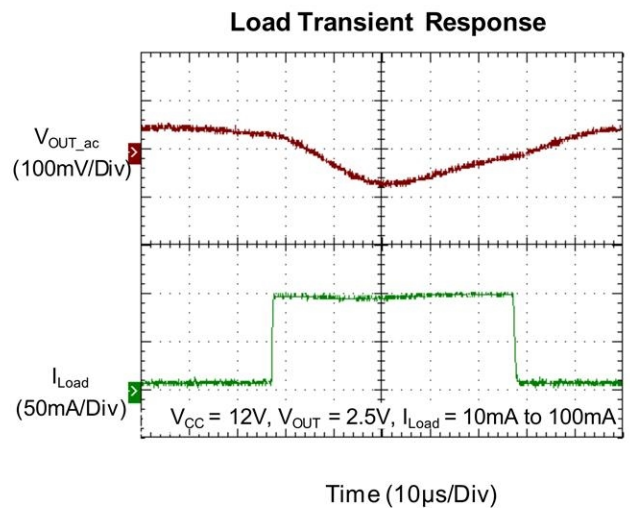
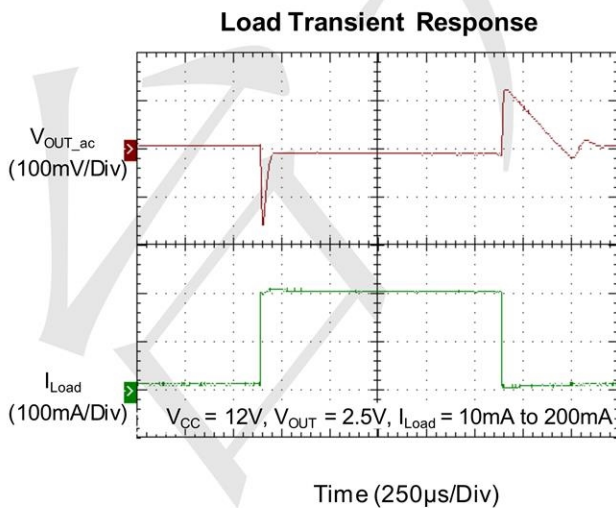
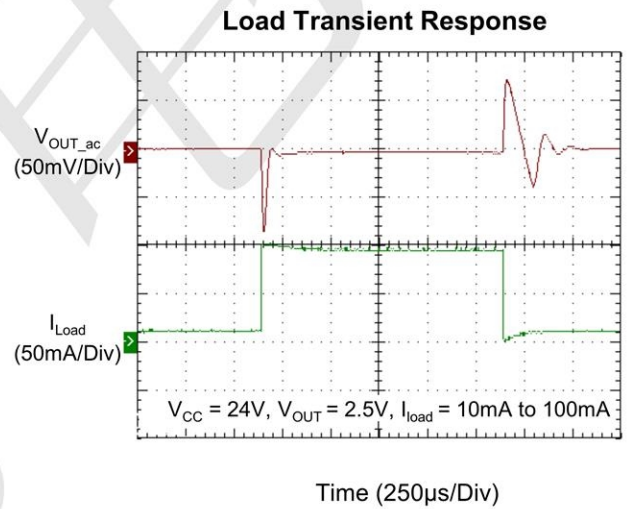
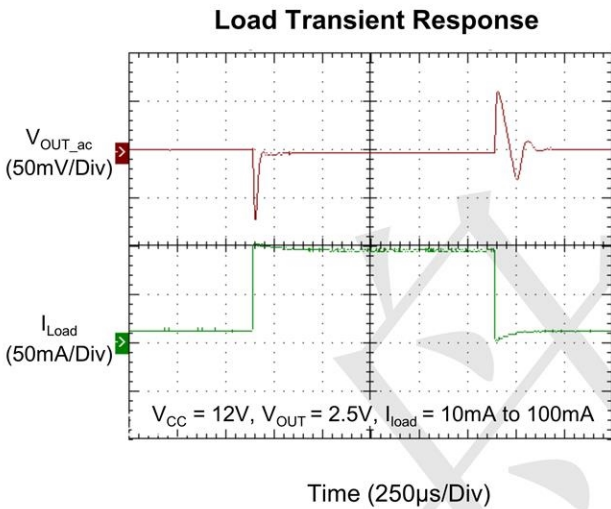
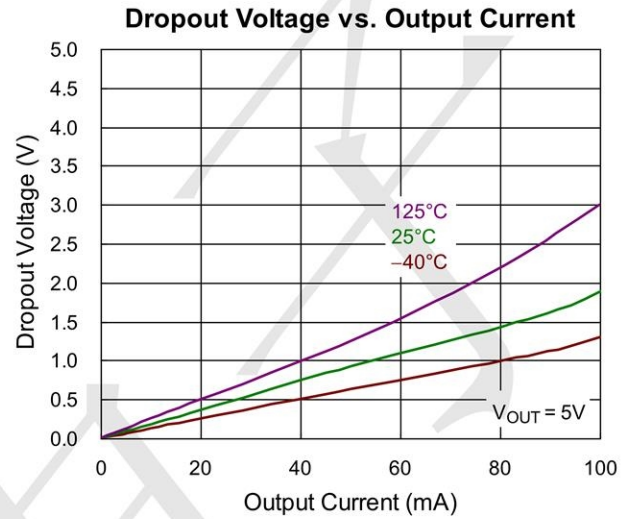
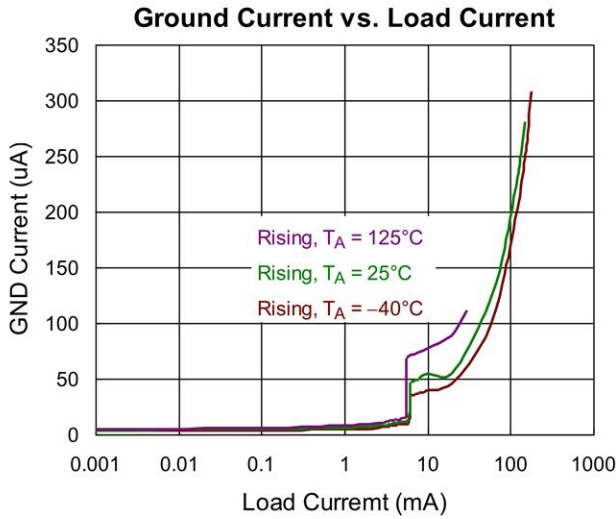





Line Transient Response

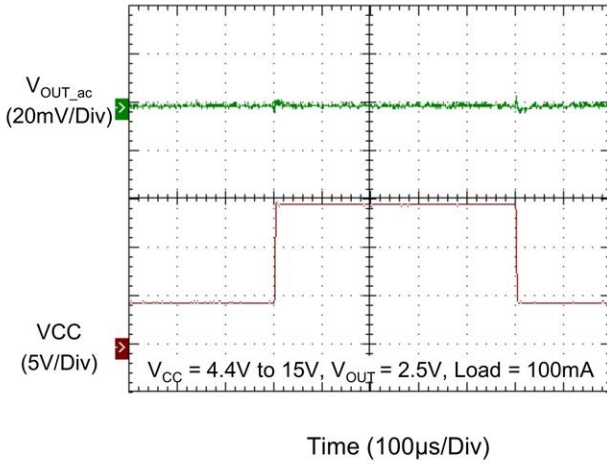

Line Transient Response

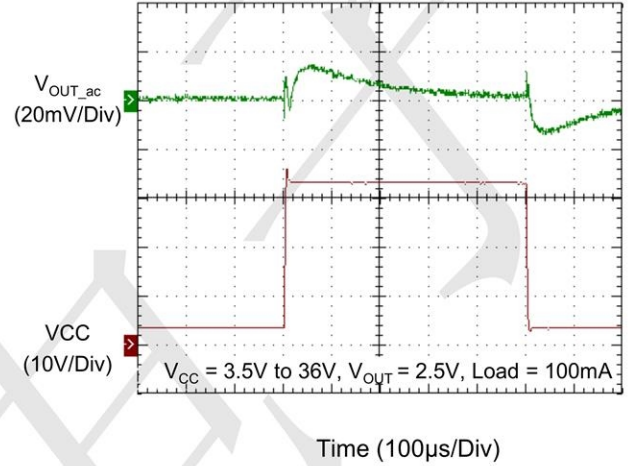

Power On from EN

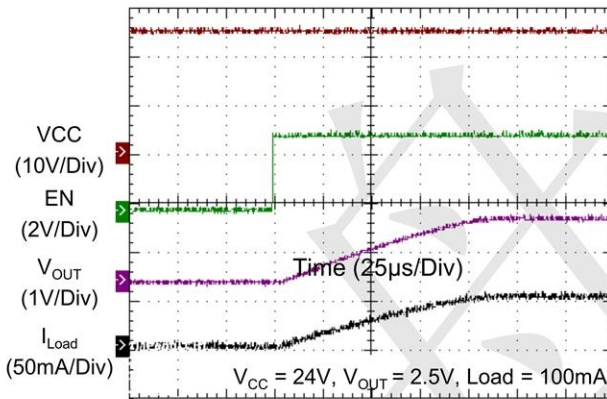

Power Off from EN

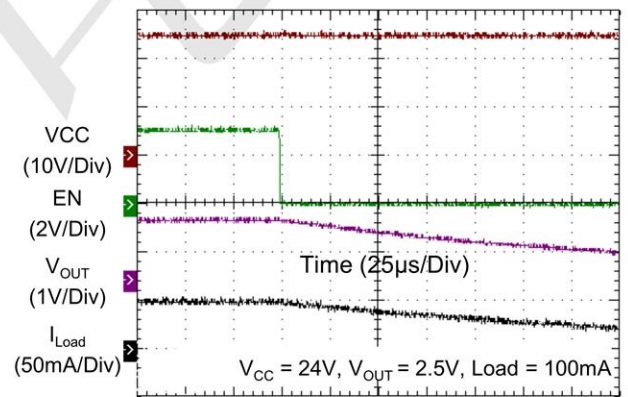





**Package informantion**

SOT23-5

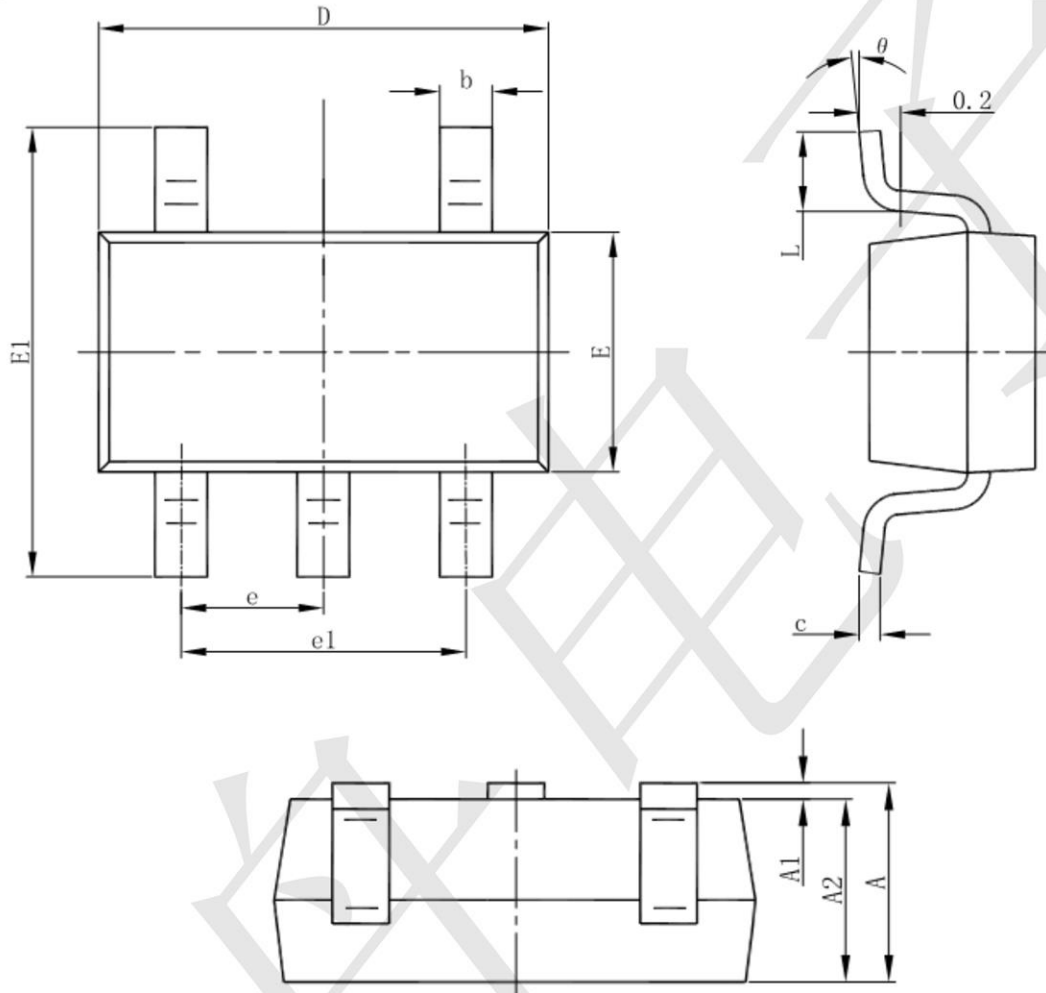

Symbol	Dimensions In Millimeters		Dimensions In Inches	
	Min	Max	Min	Max
A	1.050	1.250	0.041	0.049
A1	0.000	0.100	0.000	0.004
A2	1.050	1.150	0.041	0.045
b	0.300	0.500	0.012	0.020
c	0.100	0.200	0.004	0.008
D	2.820	3.020	0.111	0.119
E	1.500	1.700	0.059	0.067
E1	2.650	2.950	0.104	0.116
e	0.950(BSC)		0.037(BSC)	
e1	1.800	2.000	0.071	0.079
L	0.300	0.600	0.012	0.024
θ	0°	8°	0°	8°