

1 Scope:

- 1.1 This specification is applicable to lead free and halogen free of RoHS directive for LRS 4 terminals Series metal alloy low-resistance shunt resistor.
- 1.2 This product is for automotive electronic application.
- 1.3 AEC-Q200 qualified, grade 1.

2 Explanation Of Part Numbers:

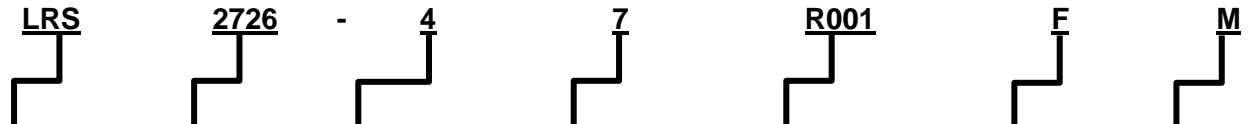

Type	Size (inch)	Number of Terminals	Rated Power	Resistance (4~6 Digits)	Tolerance	Packaging
Metal Alloy Low-Resistance Shunt Resistor	<ul style="list-style-type: none"> • 2726 • 4026 	4: 4 terminals	<ul style="list-style-type: none"> • 3=3.0W • 4=4.0W • 5=5.0W • 7=7.0W 	EX: R001 = 1mΩ R003 = 3mΩ R005 = 5mΩ R0002 = 0.2mΩ R0005 = 0.5mΩ	F=± 1.0% J=± 5.0%	M=400pcs

3 Product Specifications:

Type	# of Terminals	Max. Rating Power	Max. Rating Current	Max. Overload Current	T.C.R. (ppm/°C)	Resistance Range (mΩ)	Operating Temperature Range
						F (±1%); J (±5%)	
LRS2726	4	7W	$I_r = \sqrt{P/R}$	$I_o = \sqrt{5P/R}$	±100	0.2	-55~170°C
					±75	0.3、0.5、0.7、1.0	
					±100	0.2	
					±75	0.3、0.5、0.7、1.0、2.0、3.0	
					±100	0.2	
					±75	0.3、0.5、0.7、1.0、2.0、3.0、4.0	
LRS4026	4	7W	$I_r = \sqrt{P/R}$	$I_o = \sqrt{5P/R}$	±100	0.2	-55~170°C
					±75	0.3、0.5、0.7、1.0	
					±100	0.2	
					±75	0.3、0.5、0.7、1.0、2.0、3.0	
					±100	0.2	
					±75	0.3、0.5、0.7、1.0、2.0、3.0、4.0	
LRS4026	4	4W	$I_r = \sqrt{P/R}$	$I_o = \sqrt{5P/R}$	±100	0.2	-55~170°C
					±75	0.3、0.5、0.7、1.0、2.0、3.0、4.0	
					±100	0.2	
					±75	0.3、0.5、0.7、1.0、2.0、3.0、4.0、5.0	

IE Written: 陳永輝 Checked: 李慶堂 Approved: [Signature]		QA Signing: [Signature]		Remark IT'S NOT UNDER CONTROL FOR PDF FILE PLS NOTE THE VERSION STATED.. Do not copy without permission	Issue Dep. DATA Center. Series No. 60
--	--	-----------------------------------	--	---	---

3.1 Power Derating Curve: Operating Temperature Range : - 55 ~+170 °C

For resistors operated in ambient temperatures 70°C, power rating shall be derated in accordance with the curve below:

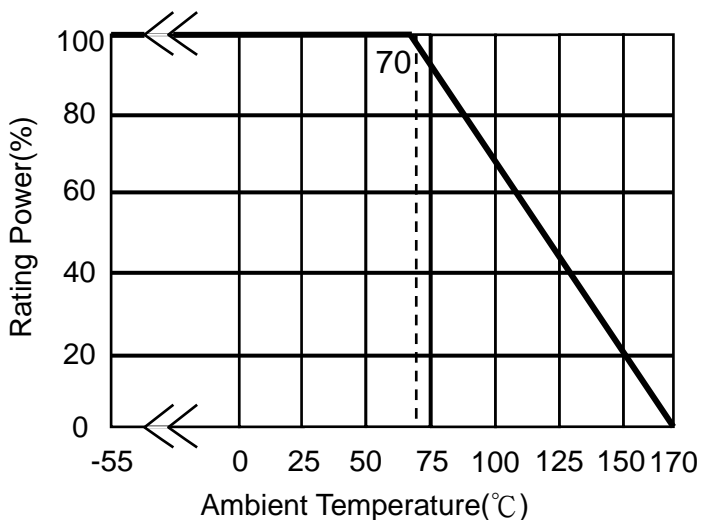

3.2 Rating Current:

The following equation may be used to determine the DC (Direct Current) or AC (Alternating Current) currents (RMS, root mean square value) of normal rated power. However, if the result value exceeds the highest current of regulated standards, the highest normal rated power is to be used.

Remark:

$$I = \sqrt{P/R}$$

I=Rating Current(A)
P= Rating Power(W)
R=Resistance(Ω)

Remark

IT'S NOT UNDER CONTROL FOR PDF FILE
PLS NOTE THE VERSION STATED..

Issue Dep.**DATA Center.**

Do not copy without permission

Series No. **60**

4 Physical Dimensions:

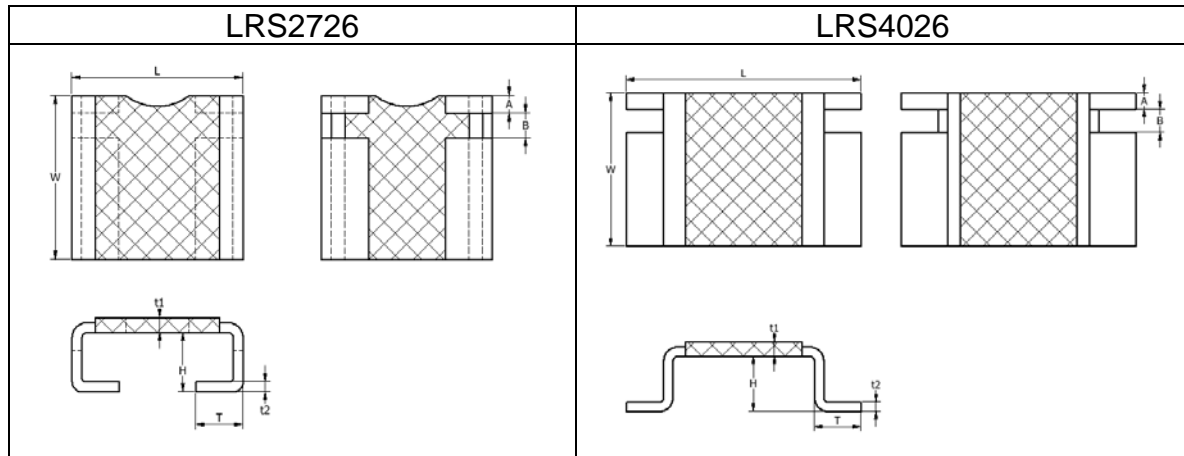

Type	Maximum Power Rating	Resistance Range (mΩ)	L	W	A	B	T	t1	t2	H	
LRS2726	7W	0.2	0.272±0.008 (6.90±0.20)	0.260 +0.014/- 0.008 (6.600+0.35/-0.20)	0.028±0.008 (0.70±0.20)	0.039±0.008 (1.00±0.20)	0.075±0.008 (1.90±0.20)	0.051±0.004 (1.30±0.10)	0.016±0.006 (0.40±0.15)	0.094±0.006 (2.40±0.15)	
		0.3						0.039±0.004 (0.99±0.10)			
		0.5						0.026±0.004 (0.65±0.10)			
		0.7						0.019±0.004 (0.47±0.10)			
		1.0						0.014±0.004 (0.35±0.10)			
	5W	2.0						0.020±0.004 (0.50±0.10)			
		4W						3.0			0.013±0.004 (0.34±0.10)
								4.0			0.013±0.004 (0.34±0.10)
								5.0			0.013±0.004 (0.34±0.10)
		LRS4026						7W			0.2
0.3	0.039±0.004 (0.99±0.10)										
0.5	0.026±0.004 (0.65±0.10)										
0.7	0.019±0.004 (0.47±0.10)										
1.0	0.014±0.004 (0.35±0.10)										
5W	2.0		0.020±0.004 (0.50±0.10)								
	4W		3.0	0.013±0.004 (0.34±0.10)							
			4.0	0.013±0.004 (0.34±0.10)							
			5.0	0.013±0.004 (0.34±0.10)							

Remark	<div style="border: 1px solid black; padding: 5px; display: inline-block;"> IT'S NOT UNDER CONTROL FOR PDF FILE PLS NOTE THE VERSION STATED.. </div>	Issue Dep. DATA Center.
	Do not copy without permission	Series No. 60

4.1 Material of Alloy

Type	# of Terminals	Watts	Material	Resistance
LRS2726	4	7W	Copper-Manganese Alloy	0.2mΩ
				0.3mΩ
				0.5mΩ
				0.7mΩ
		5W	Iron-Chromium Aluminum Alloys	1mΩ
				2mΩ
				3mΩ
				4mΩ
4W	Iron-Chromium Aluminum Alloys	4mΩ		
		5mΩ		
		3W		
		5mΩ		
LRS4026	4	7W	Copper-Manganese Alloy	0.2mΩ
				0.3mΩ
				0.5mΩ
				0.7mΩ
		5W	Iron-Chromium Aluminum Alloys	1mΩ
				2mΩ
				3mΩ
				4mΩ
4W	Iron-Chromium Aluminum Alloys	4mΩ		
		5mΩ		
		3W		
		5mΩ		

5 Reliability Performance:

5.1 Electrical Performance:

Test Item	Conditions of Test	Test Limits							
Electrical Characterization (TCR)	<ul style="list-style-type: none"> • TCR (ppm/°C) = ----- X 10⁶ • R1: resistance of room temperature • R2: resistance of 150 °C • T1: Room temperature • T2: Temperature at 150 °C • Refer to JIS C 5201-1 4.8 	Refer to Paragraph 3. general specifications							
Short Time Overload	Applied Overload for 5 seconds and release the load for about 30 minutes, then measure its resistance variance rate. (Overload condition refer to below): <table border="1" style="margin-left: 20px; border-collapse: collapse; width: 60%;"> <thead> <tr> <th style="width:20%;">Type</th> <th style="width:20%;"># of Terminals</th> <th style="width:60%;"># of rated power</th> </tr> </thead> <tbody> <tr> <td>LRS2726</td> <td rowspan="2" style="text-align: center;">4</td> <td rowspan="2" style="text-align: center;">5 times</td> </tr> <tr> <td>LRS4026</td> </tr> </tbody> </table> Refer to JIS C 5201-1 4.13	Type	# of Terminals	# of rated power	LRS2726	4	5 times	LRS4026	ΔR±1.0%
Type	# of Terminals	# of rated power							
LRS2726	4	5 times							
LRS4026									

5.2 Mechanical /Constructional Performance:

Test Item	Conditions of Test	Test Limits								
Resistance to Solder Heat	The tested resistor be immersed 25 mm/sec into molten solder of 260±5°C for 10±1secs. Then the resistor is left in the room for 1 hour, and measured its resistance variance rate. Refer to MIL-STD-202 Method 210	ΔR±1.0%								
Solderability	Add flux into tested resistors, immersion into solder bath in temperature 245±5°C for 3±0.5secs. Refer to J-STD-002	Solder coverage over 95%								
Vibration	The resistor shall be mounted by its terminal leads to the supporting terminals on the solid table. The entire frequency range :from 10 Hz to 55 Hz and return to 10 Hz, shall be transferred in 1 min. Amplitude : 1.5mm This motion shall be applied for a period of 4 hours in each 3 mutually perpendicular directions (a total of 12hrs) Refer to MIL-STD-202 Method 204	ΔR±1.0%								
Mechanical Shock	Three shocks in each direction shall be applied along the three mutually perpendicular axes of the test specimen (18 shocks). <table border="1" style="margin-left: 20px;"> <tr> <td>Peak value(g's)</td> <td>100</td> </tr> <tr> <td>Duration(ms)</td> <td>6</td> </tr> <tr> <td>waveform</td> <td>Half-sine</td> </tr> <tr> <td>Velocity change(ft/sec)</td> <td>12.3</td> </tr> </table> Refer to MIL-STD-202 Method 213	Peak value(g's)	100	Duration(ms)	6	waveform	Half-sine	Velocity change(ft/sec)	12.3	ΔR ±0.5%
Peak value(g's)	100									
Duration(ms)	6									
waveform	Half-sine									
Velocity change(ft/sec)	12.3									

5.3 Environmental Performance:

Test Item	Conditions of Test	Test Limits						
High Temperature Exposure	Put tested resistor in chamber under temperature 170±5°C for 1,000 hours. Then leaving the tested resistor in room temperature for 60 minutes , and measure its resistance variance rate. Refer to MIL-STD-202 Method 108	ΔR±1.0%						
Temperature Cycling	Put the tested resistor in the chamber under the temperature cycling which shown in the following table shall be repeated 1,000 times consecutively. Then leaving the tested resistor in the room temperature for 60 minutes, and measure its resistance variance rate. <table border="1" style="margin-left: 20px;"> <tr> <td></td> <td>Testing Condition</td> </tr> <tr> <td>Lowest Temperature</td> <td>-55 +0/-10°C</td> </tr> <tr> <td>Highest Temperature</td> <td>150 +10/-0°C</td> </tr> </table> Refer to JESD22 Method JA-104		Testing Condition	Lowest Temperature	-55 +0/-10°C	Highest Temperature	150 +10/-0°C	ΔR±1.0%
	Testing Condition							
Lowest Temperature	-55 +0/-10°C							
Highest Temperature	150 +10/-0°C							
Bias Humidity	Put the tested resistor in chamber under 85± 5°Cand 85± 5%RH with 10% bias and load the rated current for 90 minutes on, 30 minutes off, total 1,000 hours. Then leaving the tested resistor in room temperature for 60 minutes, and measure its resistance variance rate. Refer to MIL-STD-202 Method 103	ΔR±1.0%						

Remark

IT'S NOT UNDER CONTROL FOR PDF FILE
PLS NOTE THE VERSION STATED..

Issue Dep.**DATA Center.**

Do not copy without permission

Series No. **60**

5.4 Operational Life Endurance:

Test Item	Conditions of Test	Test Limits
Operational Life	Put the tested resistor in chamber under temperature $70 \pm 2^\circ\text{C}$ and load the rated current for 90 minutes on 30 minutes off, total 1000 hours. Then leaving the tested resistor in room temperature for 60 minutes, and measure its resistance variance rate. Refer to MIL-STD-202 Method 108	$\Delta R \pm 1.0\%$

6 Inductance

6.1 Inductance characteristics : $< 5\text{nH}$ (Circuit frequency is below 1MHz)

7 Measurement Point:

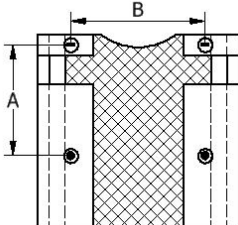
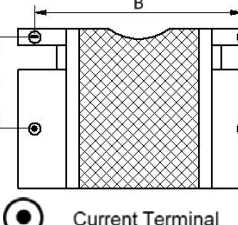
Bottom electrode	Unit : mm		
	DIM Type	A	B
 ● Current Terminal ⊖ Voltage Terminal	LRS2726-4	3.8 ± 0.05	4.4 ± 0.05
 ● Current Terminal ⊖ Voltage Terminal	LRS4026-4	3.8 ± 0.05	8.7 ± 0.05

Remark

IT'S NOT UNDER CONTROL FOR PDF FILE
PLS NOTE THE VERSION STATED..

Issue Dep. DATA Center.

Do not copy without permission

Series No. **60**

8 Taping specifications:

8.1 Tape Dimensions:

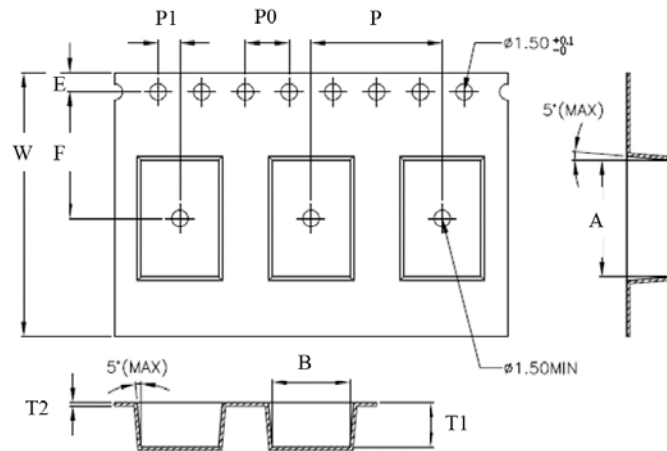

Unit: mm

Type-Terminals	DIM										
	A	B	W	E	F	T1	T2	P	P0	10*P0	P1
LRS2726-4	7.1±0.1	7.4±0.1	16.0±0.3	1.75±0.1	7.5±0.1	4.05±0.1	0.3±0.05	12.0±0.1	4.0±0.1	40.0±0.2	2.0±0.1
LRS4026-4	10.6±0.1	7.1±0.1	24.0±0.3	1.75±0.1	11.5±0.1	4.05±0.1	0.3±0.05	12.0±0.1	4.0±0.1	40.0±0.2	2.0±0.1

8.2 Packaging model:

Type	# of Terminals	Tape width	Max. Packaging Quantity (pcs/reel)
			Embossed Plastic Type
			12mm pitch
LRS2726	4	16mm	400
LRS4026		24mm	400

8.3 Reel Dimensions:

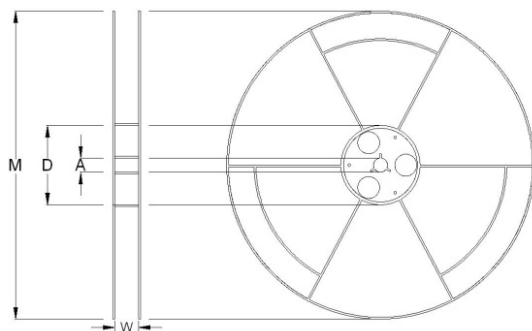

Reel Type / Tape	W	M	A	D
7" reel for 16 mm tape	17.4 ± 1.0	178 ± 2.0	13.20 ± 0.5	60.0 ± 1.0
7" reel for 24 mm tape	25.0 ± 1.0	178 ± 2.0	13.20 ± 0.5	60.0 ± 1.0

Remark

IT'S NOT UNDER CONTROL FOR PDF FILE
PLS NOTE THE VERSION STATED..

Issue Dep. DATA Center.

Do not copy without permission

Series No. **60**

8.4 Label:

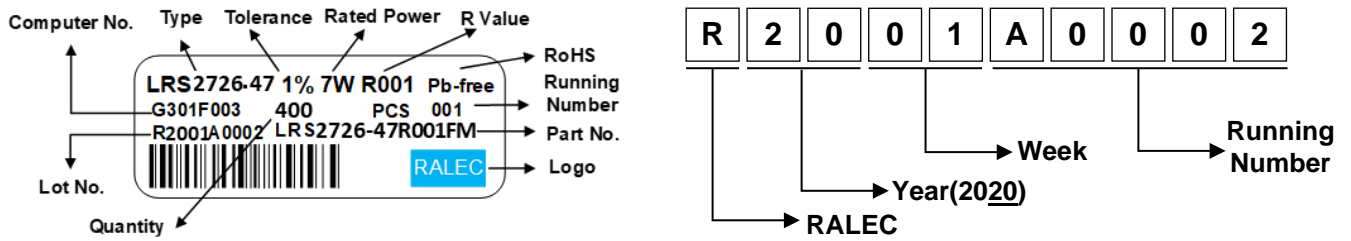

9 Technical note (This is for recommendation, please customer perform adjustment according to actual application)

9.1 Recommend soldering method:

9.1.1 This product is applicable to IR-reflow process only.(Infrared Reflow)

9.1.2 Typical examples of soldering processes that provides reliable joints without any damage are given in below:

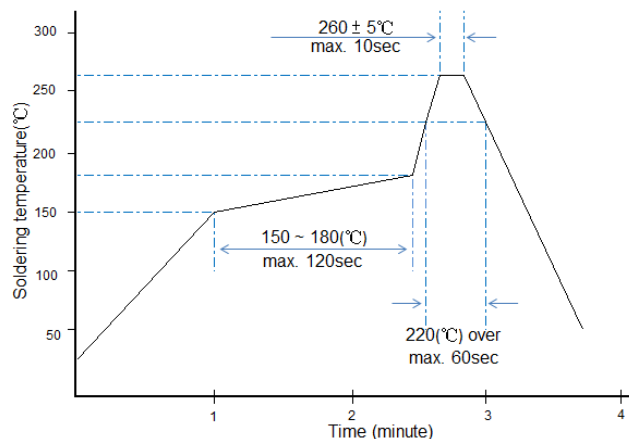

Recommended IR Reflow Soldering Profile
MEET J-STD-020D

Remark

IT'S NOT UNDER CONTROL FOR PDF FILE
PLS NOTE THE VERSION STATED..

Issue Dep. DATA Center.

Do not copy without permission

Series No. **60**

9.2 Recommend Land Pattern:

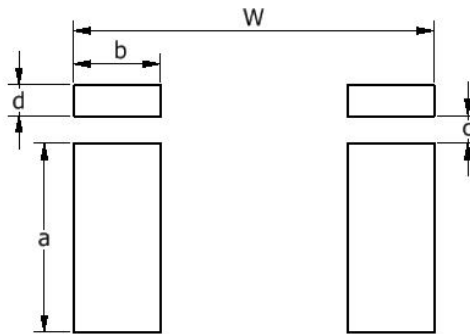

Type	# of Terminals	Resistance Range (mΩ)	Dimensions - in millimeters				
			a	b	c	d	W
LRS2726	4	0.2、0.3、0.5、0.7、1.0、2.0、3.0、4.0、5.0	5.6	2.9	0.8	0.9	7.8
LRS4026	4	0.2、0.3、0.5、0.7、1.0 、2.0、3.0、4.0、5.0	5.6	2.55	0.8	0.9	10.6

9.3 Automobile Electronic Application:

This specification is for automobile electronic use. RALEC will take no responsibility if any damage, cost or loss occurs when the product has been used in any special circumstances.

9.4 Environment Precautions:

If consumer intends to use our company product in special environment or condition (including but not limited to those mentioned below), then will need to make individual recognition of product features and reliability accordingly.

- (a) Used in high temperature and humidity environment
- (b) Exposed to sea breeze or other corrosive gas, such as Cl₂、H₂S、NH₃、SO₂ and NO₂.
- (c) Used in non-verified liquids including water, oil, chemical and organic solvents.
- (d) Using non-verified resin or other coating material to seal or coat our Company product.
- (e) After soldering, it is necessary to use water-soluble detergents to clean residual solder fluxes, even though no-clean fluxes are recommended.

9.5 Momentary Overload Precautions:

The product might be out of function when momentary overloaded. Please make sure to avoid momentary overloading while using and preserving.

Remark

IT'S NOT UNDER CONTROL FOR PDF FILE
PLS NOTE THE VERSION STATED..

Issue Dep. **DATA Center.**

Do not copy without permission

Series No. **60**

RALEC 旺詮	LRS 4-Terminals Series Metal Alloy Low-Resistance Shunt Resistor Product Specifications (Automotive Grade)	Document No.	IE-SP-180
		Released Date	2021/05/13
		Page No.	10

9.6 Operation and Processing Precautions:

- (a) Avoid damage to the edge of resistor and protective layer caused by mechanical stress.
- (b) Handle with care when printing circuit board (PCB) is divided or fixed on support body, because bending of printing circuit board (PCB) mounting will make mechanical stress for resistors.
- (c) Make sure the power rating is under the limit when using the resistor. When power rating is over the limit, the resistor will be overloaded. There might be machinery damage due to the climbing temperature.
- (d) If the resistor will be exposed under massive impact load (shock wave) in a short period of time, the working environment must be set up well before use.
- (e) Please make evaluation and confirmation when the product is well used in your company and have a through consideration of it's fail-safe design to ensure the system safety.

10 Storage and Transportation requirement:

- 10.1 The temperature condition must be controlled at 25±5°C, the R.H. must be controlled at 60±15%. The stock can maintain quality level in one years.
- 10.2 Please avoid the mentioned harsh environment below when storing to ensure product performance and its' weldability. Places exposed to sea breeze or other corrosive gas, such as Cl2、H2S、NH3、SO2 and NO2.
- 10.3 When the product is moved and stored, please ensure the correct orientation of the box. Do not drop or squeeze the box. Otherwise, the electrode or the body of the product may be damaged.

11 Attachments

- 11.1 Document Revise Record (QA-QR-027)

Remark	IT'S NOT UNDER CONTROL FOR PDF FILE PLS NOTE THE VERSION STATED..	Issue Dep. DATA Center.
	Do not copy without permission	Series No. 60

RALEC 旺詮	LRS 4-Terminals Series Metal Alloy Low-Resistance Shunt Resistor Product Specifications (Automotive Grade)	Document No.	IE-SP-180
		Released Date	2021/05/13
		Page No.	11

Legal disclaimer

RALEC, its distributors and agents (collectively, "RALEC"), hereby disclaims any and all liabilities for any errors, inaccuracies or incompleteness contained in any product related information, including but not limited to product specifications, datasheets, pictures and/or graphics. RALEC may make changes, modifications and/or improvements to product related information at any time and without notice.

RALEC makes no representation, warranty, and/or guarantee about the fitness of its products for any particular purpose or the continuing production of any of its products. To the maximum extent permitted by law, RALEC disclaims (i) any and all liability arising out of the application or use of any RALEC product, (ii) any and all liability, including without limitation special, consequential or incidental damages, and (iii) any and all implied warranties, including warranties of fitness for a particular purpose, non-infringement and merchantability.

RALEC defined this product is for general electrical use , not design for any application for automotive electrical ,life-saving or life support equipment, or any application which may inflict casualties if RALEC product failure occurred. When consumer is using or selling products of RALEC without having discussion with the sales representatives and specifically stated the applicability mentioned above in a written form, then the client need to take a full responsibility and agree to protect RALEC from punishment and damage.

Information provided here is intended to indicate product specifications only. RALEC reserves all the rights for revising this content without further notification, as long as products are unchanged. Any product change will be announced by ECN.

Remark	IT'S NOT UNDER CONTROL FOR PDF FILE PLS NOTE THE VERSION STATED..	Issue Dep. DATA Center.
	Do not copy without permission	Series No. 60