

Product Specification

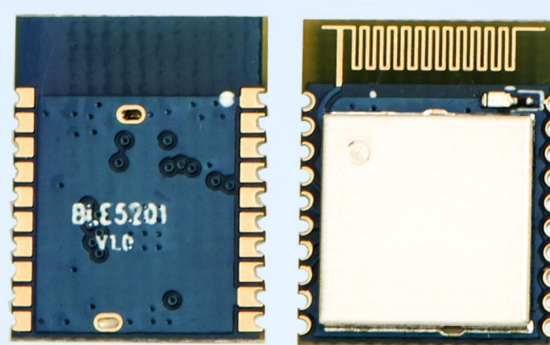

Catalogue

1. Overview.....	4
1.1 Product Introduction.....	4
1.2 Chip characteristics.....	4
1.3 Features.....	5
1.4 Application.....	6
2. Precautions for use.....	6
2.1 BLE description.....	6
2.1.1 MTU.....	6
2.2 Precautions for module application.....	6
2.2.1 Judgment conditions for the role of master and slave.....	6
2.2.2 Response of distance to data transmission rate.....	6
2.2.3 Module data transmission speed changes.....	7
2.2.4 Module current may be too high in low power consumption mode.....	7
3. Electrical Characteristics.....	7
4. Hardware parameters.....	8
4.1 Internal block diagram.....	8
4.2 Pin definition.....	8
4.3 Peripheral routing.....	9
4.4 Typical application circuit.....	12
5. Function Description.....	13
5.1 Role description.....	13
5.1.1 Host.....	13
5.1.2 Slave.....	15
5.2 Power mode.....	15
5.2.1 Low power mode.....	15
5.2.2 Wake mode.....	16
5.3 Data transparent transmission.....	16
5.5 UUID description.....	17
5.6 Connection handle.....	17
5.7 Over-the-air upgrade (OTA DFU) and serial port upgrade.....	17
5.8 Status printing.....	17
6. AT command.....	18
6.1 Configuration mode description.....	18
6.2 Error code.....	18
6.3 AT command set.....	19
6.3.1 Test instruction.....	19
6.3.2 AT+VERSION Query the firmware version number.....	19

6.3.3 AT+MAC Query module mac address.....	19
6.3.4 AT+RESET Restart instruction.....	20
6.3.5 AT+DEFAULT Restore default parameters.....	20
6.3.6 AT+NAME Modify module name.....	20
6.3.7 AT+UUID Modify service UUID.....	20
6.3.8 AT+ROLE Switch master and slave roles.....	20
6.3.9 AT+UART Modify serial port configuration parameters.....	21
6.3.10 AT+ADVINT Modify the broadcast interval.....	21
6.3.11 AT+INQINT Modify the scan interval.....	22
6.3.12 AT+POWER Modify transmit power.....	22
6.3.13 AT+ADDBLACKLIST Add scan blacklist.....	22
6.3.14 AT+BLACKLIST Query scan blacklist.....	23
6.3.15 AT+DELBLACKLIST Remove scan blacklist.....	23
6.3.16 AT+ADVSCANPHY Rate used when initiating broadcast/scanning and requesting a connection.	23
6.3.17 AT+CONNPHY The transmission rate used when the Bluetooth connection sends and receives data.....	24
6.3.18 AT+SCAN Module scan instruction.....	24
6.3.19 AT+CONA Connect Bluetooth device through mac address.....	25
6.3.20 AT+LINK View connected device information.....	25
6.3.21 AT+DISC Disconnect Bluetooth connection by link number.....	26
6.3.22 AT+ENBOND Enable binding.....	26
6.3.23 AT+READBOND Read bound device information.....	26
6.3.24 AT+CLRBOND Delete binding information.....	27
6.3.25 AT+UPDATE.....	27
7. Quick guide.....	27
7.1 Quick to use.....	27
7.1.1 Environmental preparation.....	27
7.1.2 Auto connect.....	27
7.1.3 Manually connect.....	28
7.1.4 Disconnect.....	29
7.2 Firmware upgrade.....	29

Note: Revision History

Revision	Date	Comment
V1.0	2021-4	First release
V1.1	2021-7	Modify the content of the specification; add some AT commands; modify the firmware function to make it comp with other products
V1.2	2021-9	Modified the entire content of 7.2 firmware upgrade
V1.3	2021-12	A variety of transmission rates have been added to meet different usage environments; Part of AT commands

1. Overview

1.1 Product Introduction

The company's BLE5201 Bluetooth data transmission module uses Bluetooth 5.2 protocol and uses Silicon Labs' EFR32BG22C224 SOC chip. It has the characteristics of low power consumption, small size, long transmission distance, and strong anti-interference ability.

BLE5201 has ultra-low transmit and receive current, high-performance, low-power M33 core, which can extend the life of button batteries to ten years. Target applications include Bluetooth Mesh low-power nodes, smart door locks, personal healthcare and fitness equipment. The SOC's Bluetooth Angle of Arrival (AoA) and Angle of Departure (AoD) functions and positioning accuracy within 1 meter will also benefit applications such as asset tracking tags, beacons, and indoor navigation. EFR32BG22C224 SOC provides IQ sampling capability, suitable for direction finding applications, and supports 125 KB and 500 KB Bluetooth Low Energy Coded PHY, which can increase the receiving sensitivity to -106 dBm. Supports applications that require direction finding or low energy Bluetooth Mesh nodes.

The BLE5201 Bluetooth data transmission module is produced and tested strictly using lead-free technology, and meets RoHS and Reach standards.

1.2 Chip characteristics

EFR32BG22C224 chip has rich peripheral functions, such as PWM, UART, interrupt, I2C, SPI, timer and so on. Therefore BLE5201 can also be used as a common MCU for secondary development. It has the following characteristics:

- ◆ RF frequency range: 2400-2483.5MHz
- ◆ Transmitting power: up to 6dBm
- ◆ 1.71-3.8V power supply
- ◆ Ultra low power consumption static mode <5uA
- ◆ High-performance 32 Cortex®-M33 core with a maximum operating frequency of 76.8MHz
- ◆ Up to 512kB inside the chip, re-erasable Flash and 32kB RAM

- ◆ Support 2(G)FSK, OQPSK DSSS, (G)MSK light modulation formats
- ◆ 2 analog-digital converters (ADC): 12-bit, 1Msps; 16-bit, 76.9Ksps
- ◆ 18 general-purpose I/O pins with output state retention and asynchronous interrupt function
- ◆ 8-channel DMA controller
- ◆ 12-channel Peripheral Reflective System (PRS)
- ◆ 4 16-bit timers/counters (3 compare/capture/PWM channels)
- ◆ 32-bit real-time counter
- ◆ 24-bit low-power timer for waveform generation
- ◆ 1 watchdog timer
- ◆ 2 universal synchronous/asynchronous receivers/transmitters(UART/SPI/SmartCard(ISO 7816)/IrDA/I2S)
- ◆ 1 enhanced universal asynchronous receiver/transmitter (EUART)
- ◆ 2 I2C interfaces with SMBus support
- ◆ Digital microphone interface (PDM)
- ◆ Optional RFSense in OOK mode
- ◆ Chip temperature sensor with +/-1.5°C accuracy after single-point calibration

1.3 Features

- ◆ Developed based on Bluetooth BLE5.2 protocol
- ◆ Support single slave and one master with multiple slaves, can connect multiple slaves at the same time, up to 8 connections
- ◆ Support 2 working modes of configuration and transparent transmission
- ◆ Support over-the-air upgrade (OTA DFU)
- ◆ Support low power sleep
- ◆ Support automatic broadcasting, scanning, connection
- ◆ Support manual connection and automatic connection 2 connection methods
- ◆ Support custom 16-bit UUID, including one Service uuid and two Characteristic uuid
- ◆ Maximum transmission distance 150m (6dBm, Coded PHY)
- ◆ The maximum MTU is 247 bytes
- ◆ Support automatic binding
- ◆ Support multiple serial port parameter configuration

1.4 Application

- ◆ Wireless meter reading wireless sensor
- ◆ Smart home
- ◆ Industrial remote control, telemetry
- ◆ Smart buildings, smart buildings
- ◆ Automated data collection
- ◆ Health sensor
- ◆ Smart wearable device
- ◆ Smart robot
- ◆ Wireless sensing
- ◆ Electronic tags
- ◆ Intelligent control

2. Precautions for use

2.1 BLE description

2.1.1 MTU

Refers to the payload size of BLE air single packet data. The MTU of the BLE4.0/4.1 protocol is 27 bytes, which can be expanded to 251 bytes from the MTU of BLE4.2 and higher. In actual use, the single packet data is MTU-3, that is, the user can send a maximum of 24 bytes using BLE4.0/4.1 protocol single packet, and BLE4.2 and higher versions can be expanded to 247 bytes.

It should be noted that in actual applications, the MTU of different devices will be different.

2.2 Precautions for module application

2.2.1 Judgment conditions for the role of master and slave

When the module actively scans and connects to other Bluetooth devices, the module assumes the role of the master in this connection; when the module is connected by other Bluetooth devices due to broadcasting itself, the module acts as the slave in this connection.

2.2.2 Response of distance to data transmission rate

The module uses PCB antenna. Compared with ceramic antennas, BLE wireless signals have

stronger transmitting and receiving capabilities with external antennas. Nevertheless, the data transmission speed of the module will still be attenuated due to the increase in distance and the output power of the power supply.

2.2.3 Module data transmission speed changes

The time from the module's data sending to receiving will increase as the distance increases. When the module is the master, multiple slaves can be connected, and the sending data is sent in the form of polling the link number. The total sending-receiving time of the data will change due to the number of connections.

2.2.4 Precautions for using Coded PHY of the module

When the module enables Coded PHY to scan/broadcast, and to send and receive data after the connection is established, compared with 1M PHY, although the transmission rate is sacrificed and the power consumption is increased, it obtains a longer transmission distance.

3. Electrical Characteristics

Parameter		Performance			Remark
		Min.	Typ.	Max.	
Operating Voltage(V)		1.8	3.3	4.3	>= 3.3V guaranteed output power
Transmission level(V)			3.3		
Operating temperature(°C)		-40		85	Industrial design
Working frequency(MHz)		2400		2483.5	
Transmit power(dBm)		0		6	
Receiving sensitivity(dBm)			-94.6		
Power consumption	Emission current (mA)		7.5		
	Receive current (mA)		8.5		
	Sleep current (uA)		< 5		When there is no connection
Idle state current (mA)			6.58		Idle state: refers to no connection, no broadcasting/scanning of the module

4. Hardware parameters

4.1 Internal block diagram

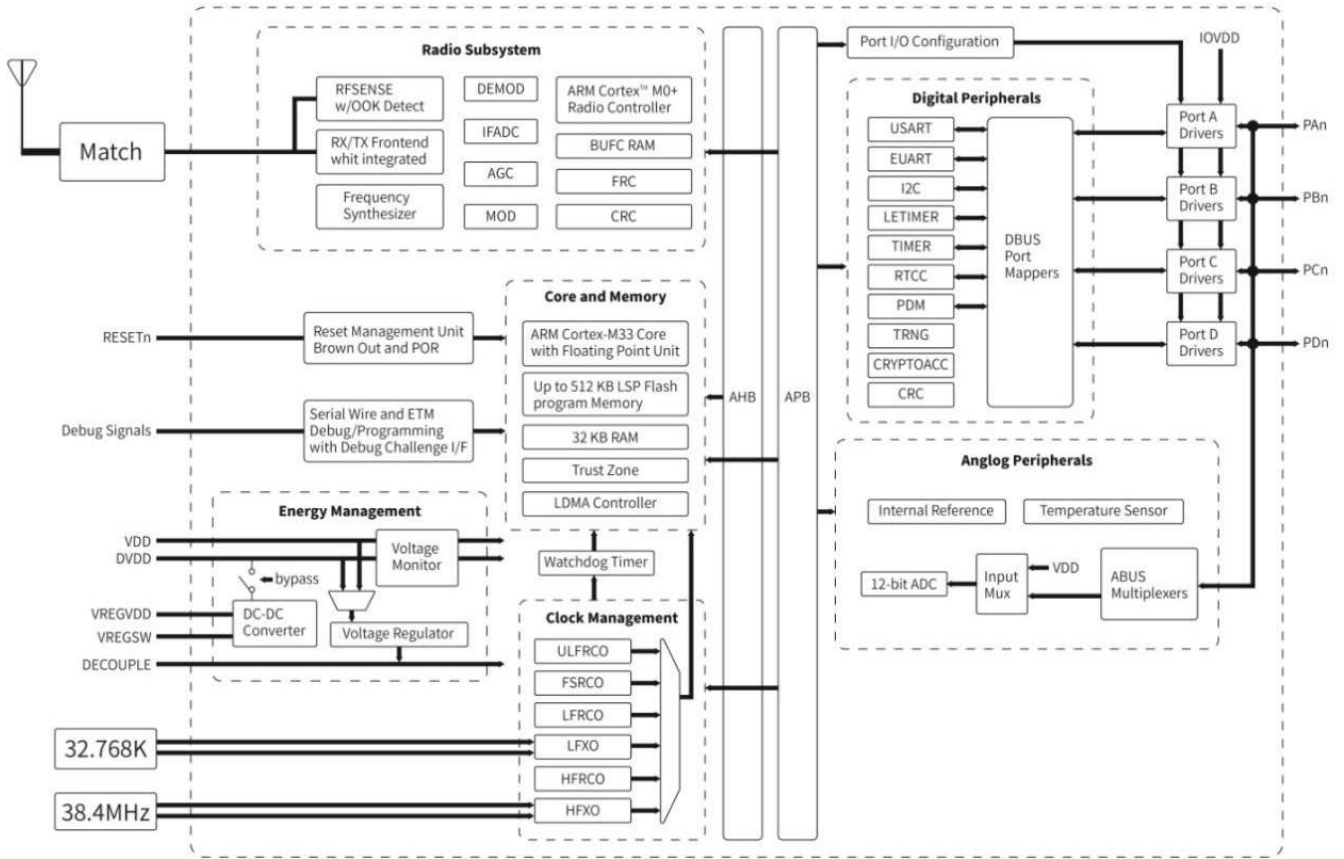

4.2 Pin definition

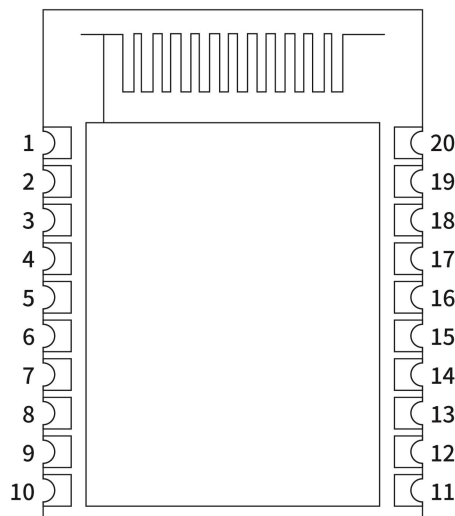

Pin NO.	Pin name	Pin direction	Pin function	Description
1	GND	Enter	Power ground	
2	PA00	Enter	Disconnect pin	Pull up by default. Low level: disconnect all Bluetooth connections and stop broadcasting/scanning; high level: resume broadcasting/scanning
3	PA01		SWCLK	
4	PA02		SWDIO	
5	PA03	Enter	Wake-up pin CS	Default pull-up: low level work, high level sleep
6	PA04	Enter	Module selection SET	Pull up by default. High level: transparent transmission mode; low level: configuration mode
7	PA05		TXD	Module serial data sending pin
8	PA06		RXD	Module serial port data receiving pin
9	GND		Power ground	
10	VCC		Power positive	
11	PC00		GPIO	
12	PC01		GPIO	
13	PC02		GPIO	
14	PC03		GPIO	
15	PC04		GPIO	
16	PC05		GPIO	
17	PB02	Output	Sleep state	Wake-up mode: high level; low power consumption mode: low level
18	PB01	Output	Mode status	Transparent transmission mode: low level; configuration mode: high level
19	RESET	Output	Reset	Built-in pull-up resistor, active low
20	PB00	Output	Connection Status	With connection: high level; no connection: low level

4.3 Peripheral routing

All GPIOs of BLE5201 can be routed and mapped to use peripheral resources, and can be used as MCU to use the following functions.

Note: These peripherals do not represent the functions possessed by the factory program of this

module. Customers need to contact our company to customize or write their own programs to realize them.

外设资源	端口		
	PA	PB	PC
CMU.CLKIN0			Available
CMU.CLKOUT0			Available
CMU.CLKOUT1			Available
CMU.CLKOUT2	Available	Available	
EUART0.CTS	Available	Available	Available
EUART0.RTS	Available	Available	Available
EUART0.RX	Available	Available	Available
EUART0.TX	Available	Available	Available
FRC.DCLK			Available
FRC.DFRAME			Available
FRC.DOUT			Available
I2C0.SCL	Available	Available	Available
I2C0.SDA	Available	Available	Available
I2C1.SCL			Available
I2C1.SDA			Available
LETIMER0.OUT0	Available	Available	
LETIMER0.OUT1	Available	Available	
MODEM.ANT0	Available	Available	Available
MODEM.ANT1	Available	Available	Available
MODEM.ANT_ROLL_OVER			Available
MODEM.ANT_RR0			Available
MODEM.ANT_RR1			Available
MODEM.ANT_RR2			Available
MODEM.ANT_RR3			Available
MODEM.ANT_RR4			Available
MODEM.ANT_RR5			Available
MODEM.ANT_SW_EN			Available
MODEM.ANT_SW_US			Available
MODEM.ANT_TRIG			Available
MODEM.ANT_TRIG_S TOP			Available
MODEM.DCLK	Available	Available	
MODEM.DIN	Available	Available	
MODEM.DOUT	Available	Available	
PDM.CLK	Available	Available	Available
PDM.DAT0	Available	Available	Available
PDM.DAT1	Available	Available	Available

PRS.ASYNCH0	Available	Available	
PRS.ASYNCH1	Available	Available	
PRS.ASYNCH10			Available
PRS.ASYNCH11			Available
PRS.ASYNCH2	Available	Available	
PRS.ASYNCH3	Available	Available	
PRS.ASYNCH4	Available	Available	
PRS.ASYNCH5	Available	Available	
PRS.ASYNCH6			Available
PRS.ASYNCH7			Available
PRS.ASYNCH8			Available
PRS.ASYNCH9			Available
PRS.SYNCH0	Available	Available	Available
PRS.SYNCH1	Available	Available	Available
PRS.SYNCH2	Available	Available	Available
PRS.SYNCH3	Available	Available	Available
TIMER0.CC0	Available	Available	Available
TIMER0.CC1	Available	Available	Available
TIMER0.CC2	Available	Available	Available
TIMER0.CDTI0	Available	Available	Available
TIMER0.CDTI1	Available	Available	Available
TIMER0.CDTI2	Available	Available	Available
TIMER1.CC0	Available	Available	Available
TIMER1.CC1	Available	Available	Available
TIMER1.CC2	Available	Available	Available
TIMER1.CDTI0	Available	Available	Available
TIMER1.CDTI1	Available	Available	Available
TIMER1.CDTI2	Available	Available	Available
TIMER2.CC0	Available	Available	
TIMER2.CC1	Available	Available	
TIMER2.CC2	Available	Available	
TIMER2.CDTI0	Available	Available	
TIMER2.CDTI1	Available	Available	
TIMER2.CDTI2	Available	Available	
TIMER3.CC0			Available
TIMER3.CC1			Available
TIMER3.CC2			Available
TIMER3.CDTI0			Available
TIMER3.CDTI1			Available
TIMER3.CDTI2			Available
TIMER4.CC0	Available	Available	
TIMER4.CC1	Available	Available	
TIMER4.CC2	Available	Available	

TIMER4.CDTI0	Available	Available	
TIMER4.CDTI1	Available	Available	
TIMER4.CDTI2	Available	Available	
USART0.CLK	Available	Available	Available
USART0.CS	Available	Available	Available
USART0.CTS	Available	Available	Available
USART0.RTS	Available	Available	Available
USART0.RX	Available	Available	Available
USART0.TX	Available	Available	Available
USART1.CLK	Available	Available	
USART1.CS	Available	Available	
USART1.CTS	Available	Available	
USART1.RTS	Available	Available	
USART1.RX	Available	Available	
USART1.TX	Available	Available	

4.4 Typical application circuit

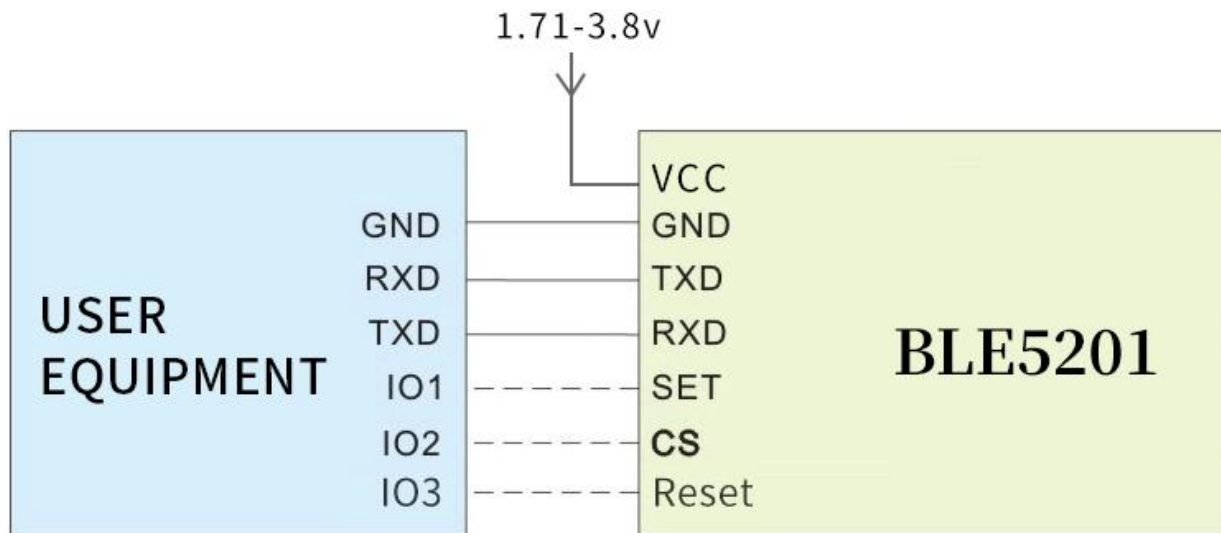

- In the transparent transmission mode, the module will automatically scan the connected slaves.
- Supports one-master and multiple-slave connections. Up to 8 connections.

5.1.1.1 Host connection strategy

The module filters broadcast packets by service UUID.

UUID filtering is based on the content filtering configured by AT+UUID, and this condition cannot be closed.

The module will analyze the scanned broadcast packet during scanning. If the broadcast packet contains Service UUID and the UUID is the same as the Service UUID of the module itself, the module will automatically initiate a connection. After the connection is established, the module as the host role will try to read the Characteristic UUID under the Service UUID of the peer device. If the module does not read the Service UUID and the Characteristic UUID under it, or the UUID value read does not match the module itself, the module will automatically disconnect its connection.

This filter condition applies to manual connection and automatic connection.



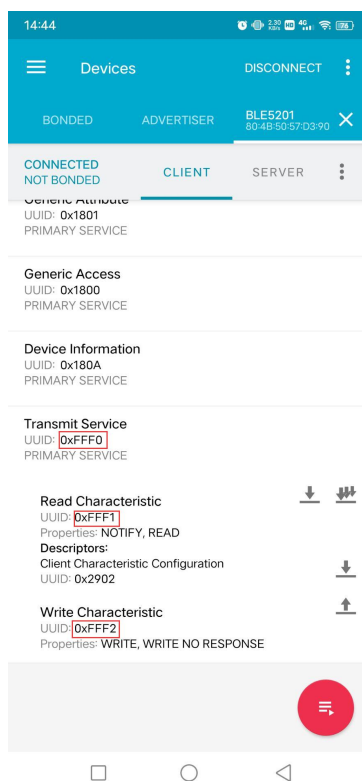

5.1.2 Slave

- In the configuration mode, send the command `AT+ROLE=0` to switch to the slave role.
- In the transparent transmission mode, the module will automatically broadcast itself.
- The broadcast content includes the device name, mac address, and Service UUID required for transparent data transmission.

5.2 Power mode

The module supports 2 power modes: low power consumption mode and wake-up mode.

5.2.1 Low power mode

Low power consumption mode means that when the module enters this mode, the BLE function will continue to run, turn off some peripherals, stop broadcasting and scanning, in order to minimize the power consumption of the module when it is running.

In low power consumption mode, the serial port function will be closed. When there is an undischarged connection, such as the module receives data from the opposite end, or the connection status changes, the module will temporarily wake up to restore the serial port function and process related tasks. After the task is completed, the module will go to sleep immediately.

when there is no task temporarily.

How to enter the low-power mode: pull up the CS pin, when the indicator pin is pulled low, it means that it has entered the low-power mode.

How to exit the low-power mode: pull down the CS pin.

When the module is connected, it enters the low power consumption mode. The module may still maintain the connection for a short time. In this case, the current will be high, but it is always less than 1mA.

5.2.2 Wake mode

Wake-up mode refers to the state when the module is operating normally outside of the low-power mode, and all peripherals and functions are operating normally.

How to wake up: pull down the CS pin.

5.3 Data transparent transmission

Data transparent transmission means that the data received by the serial port is sent to the peer device via BLE without any processing, or the data received by BLE is output to the serial port without any processing.

When the module acts as a host, the module data transparent transmission will be sent to each connected Bluetooth device by polling. Therefore, under extreme conditions, it cannot be guaranteed that each device will receive data.

5.4 Transmission rate

The module uses the 1M PHY transmission rate for data transmission by default. That is, the rate of transmission to the air after being debugged by the Bluetooth physical layer is 1 Mbit per second, which does not mean that the data transmission rate received by the Bluetooth receiver can reach 1M/bps.

Through the AT command setting, the module can change the transmission rate used when broadcasting/scanning and Bluetooth connection. The current transmission rates supported by the module are 1M PHY, 2M PHY and Coded PHY (125K and 500K).

Using Coded PHY, you can reduce the transmission rate and increase the power consumption as the

cost, so that Bluetooth devices can transmit signals over longer distances and obtain longer transmission distances, so as to better adapt to Internet of Things applications.

5.5 UUID description

The UUID values listed in the table can be modified by AT commands, except for UUID attributes.

Service UUID	FFF0		
Characteristic UUID	UUID	Attributes	Instruction
	FFF1	Read/Notify	The slave sends, the host receives the data channel
	FFF2	Write/Write no response	The host sends and the slave receives data channels

5.6 Connection handle

1. Normally, the connection handle of the module is the number of the specified link (1-8). In principle, the handle of the module connection may not be the same each time.
2. The designated link can be operated by AT commands.

5.7 Over-the-air upgrade (OTA DFU) and serial port upgrade

The module supports over-the-air upgrade and serial port upgrade. Users can also customize the firmware they need.

For specific upgrade steps, please refer to Chapter 7 Quick Use.

5.8 Status printing

The serial port will output status during some operations.

State	Print information
Connection succeeded	[CONNECTED]
Disconnect	[DISCONNECTED]

Enter configuration mode	[ENTER AT MODE]
Exit configuration mode	[EXIT AT MODE]
Enter low power mode	[ENTER SLEEP]
Exit low power mode	[EXIT SLEEP]
Bind successfully	[BOND SUCCESS]
Binding failed	[BOND FAIL]

6. AT command

The module must enter the configuration mode to send AT commands, otherwise the commands will not respond.

6.1 Configuration mode description

- All AT commands are transmitted in ASCII format.
- Command sending format: All commands start with "AT" and end with "\r\n". Commands must be capitalized except for parameters.
- Command return format: return the relevant string corresponding to the sent command, all ending with "\r\n".
- In configuration mode, in order to prevent data interference, data sent from other devices will not be displayed.
- When entering the configuration mode, the serial port parameters will be reset (115200 bps, 8 databits, 1 stopbit, None parity).

6.2 Error code

When the command sent does not meet certain conditions, the module will return an error in the format "+ERROR=<Error num>\r\n".

Error num	Instruction	Wrong reason	Solution
0		Failed to read data	
-1	Instruction does not exist	AT command characters are wrong	Check AT command string format

-2	not connected	The module has not established any connection	
-3	Maximum number of connections reached	The Bluetooth connection of the module has reached the maximum value	
-4	Parameter error	The command format is wrong or the parameter is not within the value range	Compare the instruction to determine the instruction format and value range
-5	busy	The module is executing an instruction	Wait for the instruction operation to complete
-6	Link does not exist	The module does not have a connection handle corresponding to the link number	Operate other link numbers or wait for the link number to be used before operating
-7	Unable to initiate scan/connect	The module is the slave role	Try again after switching the module to the master role
-8		Temporary blacklist is full	

6.3 AT command set

6.3.1 Test instruction

instruction	response
AT	OK
explanation	

6.3.2 AT+VERSION Query the firmware version number

instruction	response
AT+VERSION?	+VERSION=<param>
explanation	<param>:Module firmware version number

6.3.3 AT+MAC Query module mac address

instruction	response
AT+MAC?	+MAC=<param>
explanation	<param>:mac address

6.3.4 AT+RESET Restart instruction

instruction	response
AT+RESET	OK
explanation	

6.3.5 AT+DEFAULT Restore default parameters

instruction	response
AT+DEFAULT	OK
explanation	Restart and take effect immediately after sending this command.

6.3.6 AT+NAME Modify module name

instruction	response
Inquire	AT+NAME?
set up	AT+NAME=<param>
response	+NAME=<param>
explanation	<param>:Device name string, no more than 8 characters Default value: BLE5201

6.3.7 AT+UUID Modify service UUID

instruction	response
Inquire	AT+UUID?
set up	AT+UUID=<param>,<param1>,<param2>
response	+UUID=<param>,<param1>,<param2>
explanation	<param>:Service UUID <param1>:Characteristic UUID (read,notify) <param2>:Characteristic UUID (write,write no response) Value range: 0001-FFFE Default value: FFF0, FFF1, FFF2

6.3.8 AT+ROLE Switch master and slave roles

instruction	response
Inquire	AT+ROLE?
response	+ROLE=<param>

set up	AT+ROLE=<param>	OK
explanation	<param>:0——Slave; 1——Master If there is still Bluetooth connection when switching, the module will disconnect.	

6.3.9 AT+UART Modify serial port configuration parameters

instruction		response	
Inquire	AT+UART?	+UART=<param>,<param1>,<param2>,<param3>	
set up	AT+UART=<param>,<param1>,<param2>,<param3>	OK	
explanation	parameter	explanation	Ranges
	<param>	Serial port baud rate	0: 4800bps 1: 9600bps 2: 14400bps 3: 19200bps 4: 38400bps 5: 56000bps 6: 57600bps 7: 115200bps (Defaults)
	<param1>	Data bit	0: 5bits 1: 6bits 2: 7bits 3: 8bits (Defaults)
	<param2>	Check Digit	0: NONE (Defaults) 1: EVEN 2: ODD
	<param3>	Stop bit	0: 1bit (Defaults) 1: 2bit

6.3.10 AT+ADVINT Modify the broadcast interval

instruction		response	
Inquire	AT+ADVINT?	+ADVINT=<param>	
set up	AT+ADVINT=<param>	OK	
explanation	<param>: 0: 100ms (Defaults) 1: 200ms		

	2: 500ms 3: 1000ms 4: 2000ms 5: 5000ms
--	---

6.3.11 AT+INQINT Modify the scan interval

instruction		response
Inquire	AT+INQINT?	+INQINT=<param>
set up	AT+INQINT=<param>	OK
explanation	<param>: 0: 10ms (Defaults) 1: 100ms 2: 200ms 3: 500ms 4: 1000ms 5: 2000ms	

6.3.12 AT+POWER Modify transmit power

instruction		response
Inquire	AT+POWER?	+POWER=<param>
set up	AT+POWER=<param>	OK
explanation	Note: When modifying the transmit power, the system stack will be in a stopped state for a very short time, and frequent use within a short time may have unpredictable effects on the Bluetooth connection. <param>: 0: 0dBm 1: 1dBm 2: 2dBm 3: 3dBm 4: 4dBm 5: 5dBm 6: 6dBm (Defaults)	

6.3.13 AT+ADDBLACKLIST Add scan blacklist

instruction	response
-------------	----------

set up	AT+ADDBLACKLIST=<param>	OK
instruction	<p>Add the mac address to the scanning blacklist and apply it immediately after exiting the configuration mode. When the module automatically scans, it will automatically filter the devices corresponding to the mac address and no longer connect. The blacklist can store up to 8 mac addresses.</p> <p>The blacklist will not be saved when the power is turned on, and will be cleared every time the power is turned on.</p> <p><param>: device mac address</p>	
Example	<p>Command: AT+ADDBLACKLIST=112233445566\r\n</p> <p>Return: OK\r\n</p>	

6.3.14 AT+BLACKLIST Query scan blacklist

instruction		response
set up	AT+ADDBLACKLIST?	
instruction	Query all mac addresses in the blacklist.	
Example	send	AT+ADDBLACKLIST?
	return	+ADDBLACKLIST[0]=123456789abc +ADDBLACKLIST[1]=aabbccddeeff OK

6.3.15 AT+DELBLACKLIST Remove scan blacklist

instruction		response
set up	AT+DELBLACKLIST=<param>	OK
instruction	<p>Remove the mac address corresponding to the serial number from the blacklist so that the mac address will not be filtered in the next scan.</p> <p><param>: the serial number corresponding to the mac address, see the example in the AT+BLACKLIST command.</p>	

6.3.16 AT+ADVSCANPHY Rate used when initiating broadcast/scanning and requesting a connection

instruction	response
-------------	----------

AT+ADVSCANPHY?	+ADVSCANPHY=<param>
AT+ADVSCANPHY=<param>	OK
instruction	Save it immediately after modification and enable it in the next broadcast/scan. <param>: 0: 1M PHY (default value) 1: Coded PHY

6.3.17 AT+CONNPHY The transmission rate used when the Bluetooth connection sends and receives data

instruction	response
AT+CONNPHY?	+CONNPHY=<param>
AT+CONNPHY=<param>	OK
instruction	Save it immediately after modification, and apply the transmission rate the next time a Bluetooth connection is established. Note: Not all Bluetooth devices support 2M PHY and Coded PHY, so when this rate is applied, it may fail and other transmission rates may be applied. <param>: 0: 1M PHY (default value) 1: 2M PHY 2: 125k Coded PHY (S=8) 3: 500k Coded PHY (S=2)

6.3.18 AT+SCAN Module scan instruction

instruction	response
AT+SCAN	
explanation	After sending the command, the module will enter the scanning state for 10 seconds, and print out all the scanned device information, and scan and print up to 10 device information. In this state, some AT commands cannot be used. Send this command again in this state to end the scan earlier.
Example	instruction: AT+SCAN\r\n return: OK\r\n SCANS\r\n +SCAN: address:11:22:33:44:55:66 type:0 rssi:77\r\n +SCAN: address:aa:bb:cc:dd:ee:ff type:1 rssi:88\r\n ... +SCANE\r\n Description: Scan example. address is the mac address of the scanned module; type is

	<p>the type of the module mac address; rssi is the signal strength of the opposite module. Command: AT+SCAN\r\n return: OK\r\n SCANS\r\n +SCAN: address:11:22:33:44:55:66 type:0 rssi:77\r\n ... AT+SCAN\r\n --Input command +SCANSTOP\r\n +SCANE\r\n</p> <p>explanation: An example of interrupt scanning, a +SCANSTOP response will be returned when the scanning ends early.</p>
--	---

6.3.19 AT+CONA Connect Bluetooth device through mac address

instruction	response
AT+CONA=<param>,<param1>	OK
explanation	<param>: the mac address of the Bluetooth device to be connected <param1>: the mac address type of the Bluetooth device to be connected
Example	<p>Command: AT+CONA=112233445566,0\r\n Return: OK Description: As a host, try to establish a connection with a Bluetooth device with a Mac address of 11:22:33:44:55:66 and an address type of 0.</p>

6.3.20 AT+LINK View connected device information

instruction	response
AT+LINK	
explanation	<p>After sending the command, the module will print the related information of the connected device, including the link number, mac address, and address type. If there is no connection to the module, this command will return an error.</p>
Example	<p>Command: AT+LINK\r\n Return: +LINK=0, address:11:22:33:44:55:66 type:1\r\n +LINK=1, address:aa:bb:cc:dd:ee:ff type:0\r\n ... OK\r\n</p> <p>Note: Each connection returned when the module is in the host role contains 3 parameters: link number, mac address, and mac address type. Command: AT+LINK\r\n Return: +LINK=address:11:22:33:44:55:66 type:0\r\n</p>

	Description: The MAC address and address type of the corresponding connection returned when the module is in the slave role
--	---

6.3.21 AT+DISC Disconnect Bluetooth connection by link number

instruction		response
AT+DISC=<param>		OK
explanation	<param>: link number After successful disconnection, the serial port will output status. Note: If you do not enter the link number, it will be regarded as disconnecting all connections	
Example	Command: AT+DISC=1\r\n Return: OK\r\n Note: Disconnect the Bluetooth connection with link number 1, and the host role is applicable. Command: AT+DISC=\r\n Return: OK\r\n Note: Disconnect all Bluetooth connections	

6.3.22 AT+ENBOND Enable binding

instruction		response
Inquire	AT+ENBOND?	+ENDBOND=<param>
set up	AT+ENBOND=<param>	OK
explanation	<param>: 0: disable binding 1: Enable binding After enabling binding, the module will automatically initiate binding from the next connection.	

6.3.23 AT+READBOND Read bound device information

instruction		response
AT+READBOND		
explanation	After sending this command, the module will output all bound device information, up to 6 devices.	
Example	Command: AT+READBOND\r\n Return: +REBOND=0, address: 112233445566, type:0\r\n +REBOND=1, address:aabbccddeeff, type:0\r\n	

	<p>...</p> <p>OK\r\n</p> <p>The parameters from left to right are: binding number, binding device mac address, binding device address type</p>
--	--

6.3.24 AT+CLRBOND Delete binding information

instruction	response
AT+CLRBOND=<param>	OK
AT+CLRBOND	
explanation	<param>:Binding number
Example	Command: AT+CLRBOND=0\r\n
	Return: OK\r\n
	Command: AT+CLRBOND\r\n
	Return: OK\r\n
	Description: Delete all binding information

6.3.25 AT+UPDATE

instruction	response
AT+UPDATE	OK
explanation	Used to upgrade the firmware. After sending, the program will enter the upgrade mode, all the parameters saved after power failure will be reset automatically, and the configuration mode cannot be returned to the original way.

7. Quick guide

7.1 Quick to use

7.1.1 Environmental preparation

Hardware: 2 BLE5201 modules

Software: SSCOM serial debugging assistant

Note: Since the CS pin of the module is high by default, and the low-power mode is active high, it is necessary to pull down the CS pin in advance to use all the functions of the module normally.

7.1.2 Auto connect

After the module is powered on, pull down the SET pin to enter the configuration mode. Since the module defaults to the slave role, you need to send "AT+ROLE=1" to one of the modules to switch it to the master role.

When both modules are in transparent transmission mode, Bluetooth connection will be automatically established. After the connection is established, data can be transmitted transparently.

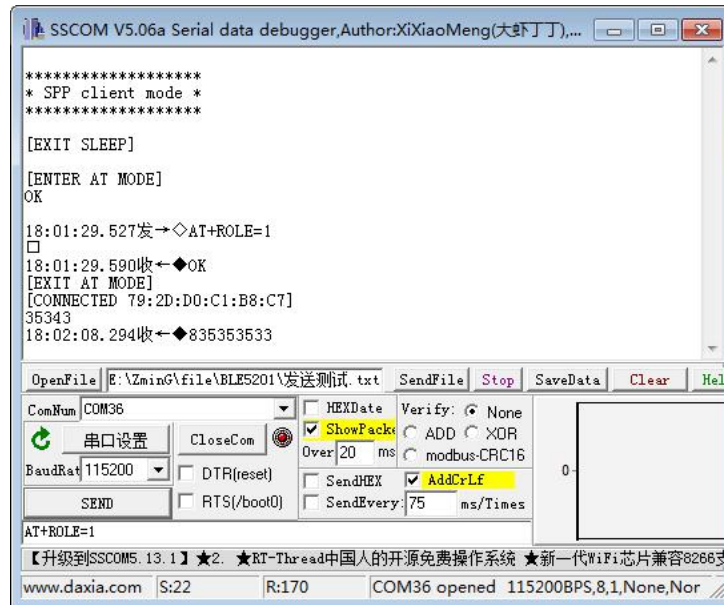

7.1.3 Manually connect

When the module is in the configuration mode, it is in an idle state and does not perform broadcast or scanning operations. At this time, manual connection can be used.

Send the command "AT+SCAN" to module A to start scanning. Module A will scan and print out the device information of Module B.

Send the connection establishment command AT+CONA to module A and wait for the connection to be established. After the connection is successfully established, pull up the SET pin to exit the configuration mode and start to transmit data transparently.

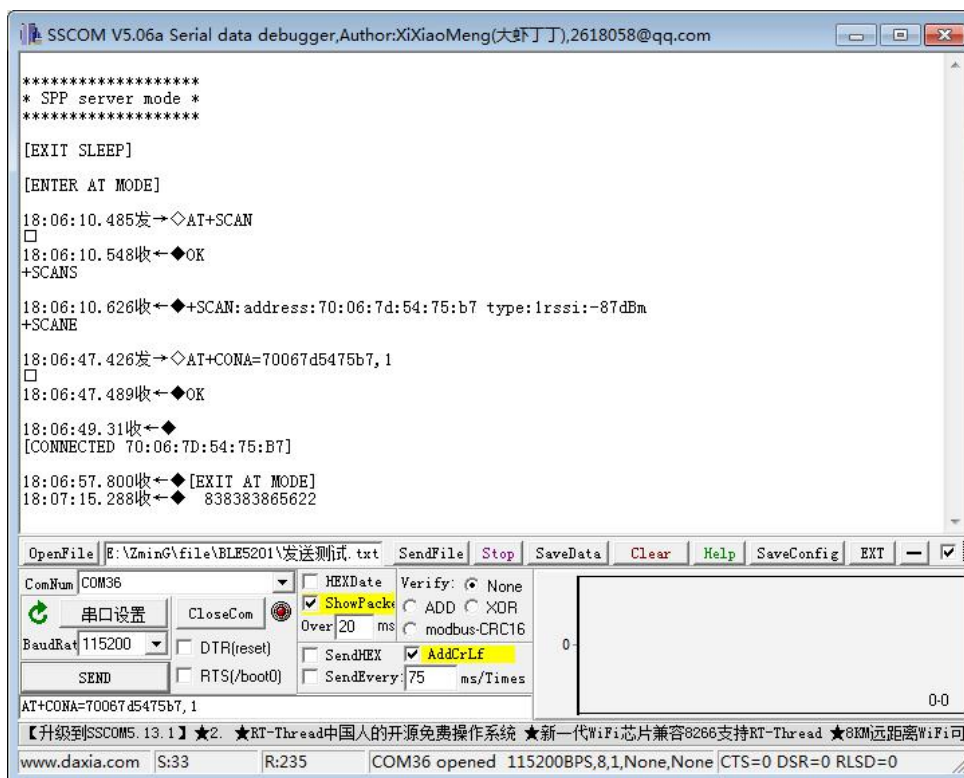

7.1.4 Disconnect

Pull down the DISC pin, or use the AT+DISC command in the configuration mode to disconnect the current connection.

When the DISC pin continues to be pulled low, the module will not perform broadcast or scanning operations and cannot establish a connection until the DISC pin returns to high level.

Use the latter method to disconnect the specified connection when there are multiple connections.

7.2 Firmware upgrade

7.2.1 OTA DFU

Open the serial debugging assistant and pull down the SET pin of BLE5201 to enter the configuration mode. After sending the "AT+UPDATE" command, BLE5201 will respond "OK\r\n" and restart the module to enter the upgrade mode

Turn on the Bluetooth function of the mobile phone, open the EFR Connect application software, click "Browser", search for and connect to the device that needs to be upgraded.

("EFR Connect" APP can be downloaded in the Google App Store)

The fixed broadcast name of the BLE5201 module in the upgrade mode is "OTA-BLE5201". Click "Connect" to connect.

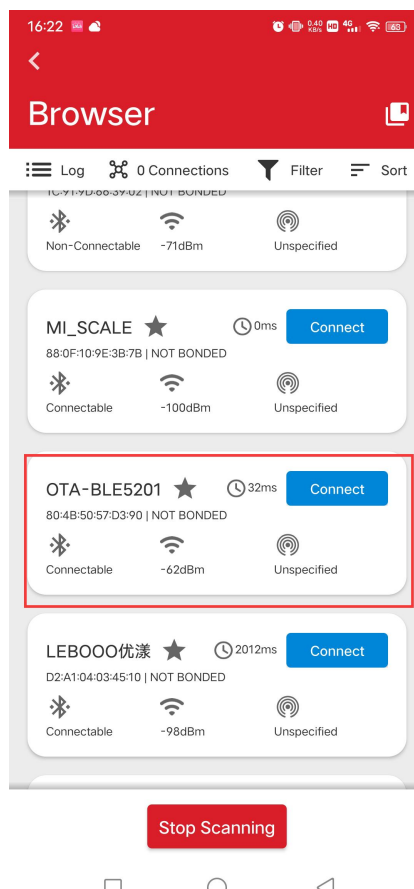
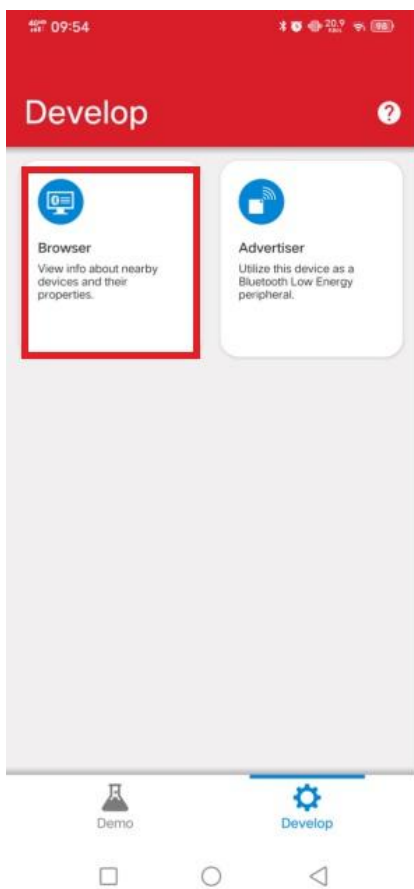

Click the menu in the upper right corner and click "OTA DFU " option.

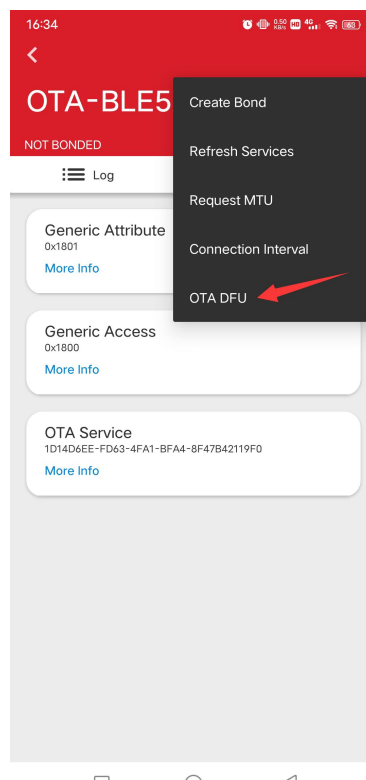
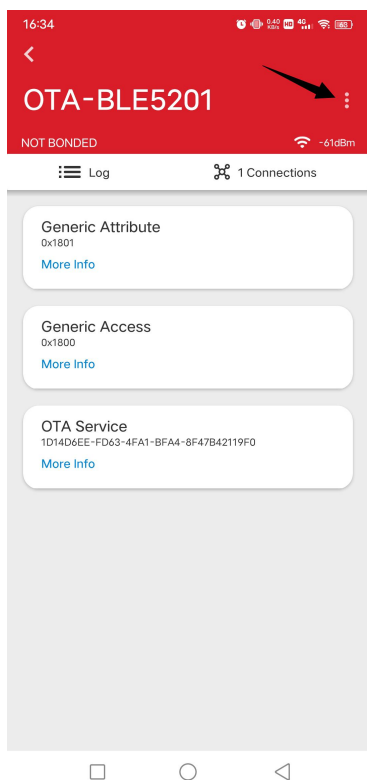

Click "FULL OTA" in the pop-up dialog box, import the Application file and Apploader file in turn, and then click the "OTA" option to start the file transfer.

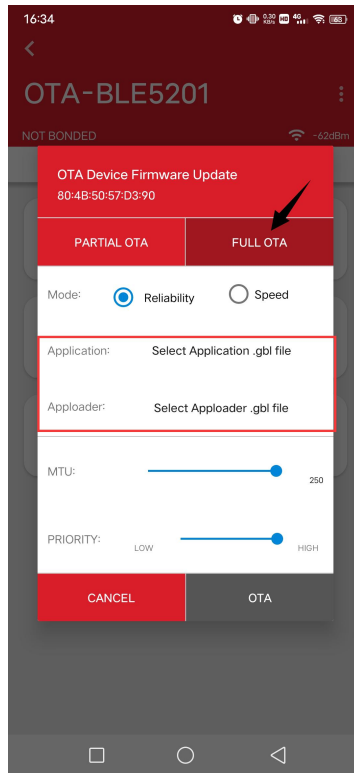

After the file transfer is complete, click "END", the Bluetooth connection will be automatically disconnected, and the module will begin to install and upgrade the firmware.

After the upgrade is completed, the module automatically restarts, and the module will run the upgraded program; if the upgrade fails, the module will run the program before the upgrade.

(Note: After entering the program upgrade mode, the parameters saved in the configuration mode will be reset)