

版次 (Ed)	变更摘要 (Change The Content)	日期 (Date)	序号 (NO.)	品名 (Name)	材质 (Material)
0	新产品发行 (New Product Launch)	2017/09/06	①	2.00 F型卧式2代WTB胶芯 2.00 Pitch R/A Wire To Board Housing(H=5.2)	LCP UL94V-0 本色 Natural

②	2.00 F型卧式2代WTB端子 2.00 Pitch R/A Wire To Board Terminal(H=5.2)	铜合金/表面镀锡 Copper Alloy/ Tin Plating
③	2.00 F型卧式WTB焊片 2.00 Pitch R/A Wire To Board Fitting Nail(H=5.6)	铜合金/表面镀锡 Copper Alloy/ Tin Plating

N-0.5±0.03 (SQ) 2.00±0.15(PITCH)

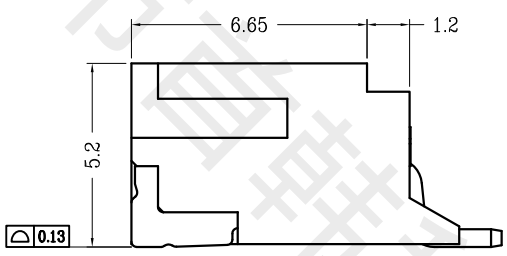
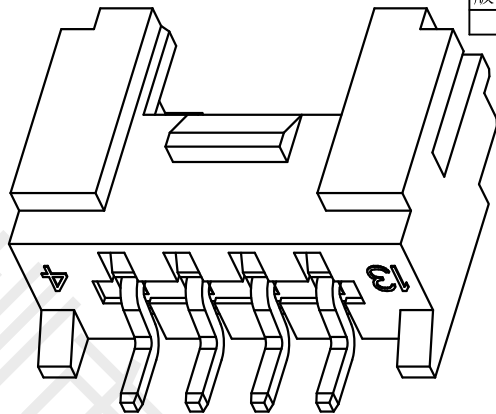
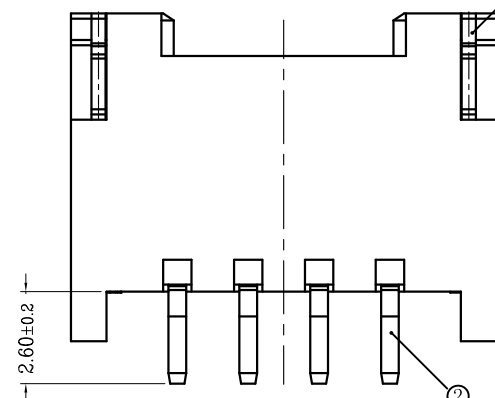
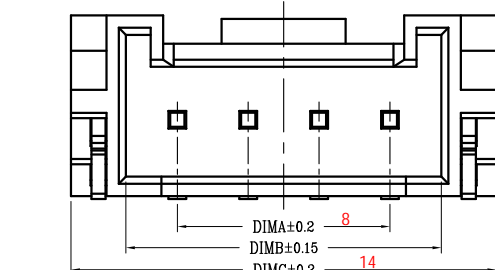
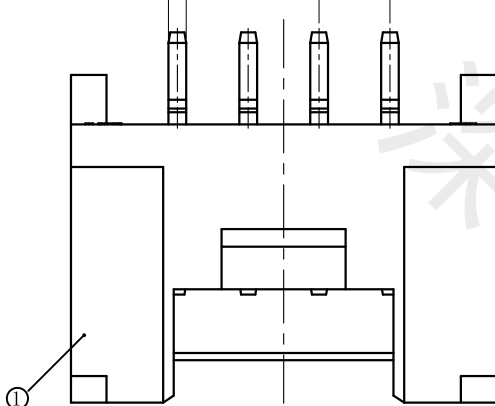

技术指标 (Technical Index):

- 塑件表面应光洁、无毛边、无明显收缩、缺陷、裂纹等现象。
(The surface of the plastic parts should be smooth, no rough edges, no obvious shrinkage, defects, cracks and other phenomena)
- 温度范围 (Temperature range): -40° C ~ +85° C.
- 额定电压 (Rated voltage): 100V, AC.
- 接触电阻 (Contact resistance):
≤55mΩ (Initial) per contact, ≤25mΩ Change allowed.
- 绝缘电阻 (Insulation resistance): ≥1000MΩ.
- 产品料号 (Product material No.):

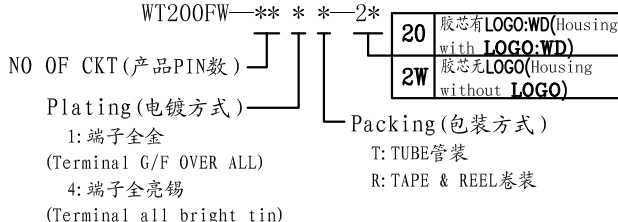

CKT	DIM A	DIM B	DIM C
2	2.00	4.90	8.00
3	4.00	6.90	10.00
4	6.00	8.90	12.00
5	8.00	10.90	14.00
6	10.00	12.90	16.00
7	12.00	14.90	18.00
8	14.00	16.90	20.00
9	16.00	18.90	22.00
10	18.00	20.90	24.00
11	20.00	22.90	26.00
12	22.00	24.90	28.00
13	24.00	26.90	30.00
14	26.00	28.90	32.00
15	28.00	30.90	34.00
16	30.00	32.90	36.00
17	32.00	34.90	38.00
18	34.00	36.90	40.00
19	36.00	38.90	42.00
20	38.00	40.90	44.00

适用线路板 (PCB LAYOUT)

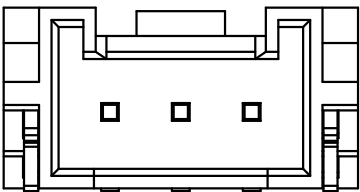
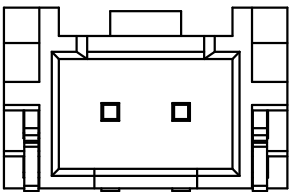
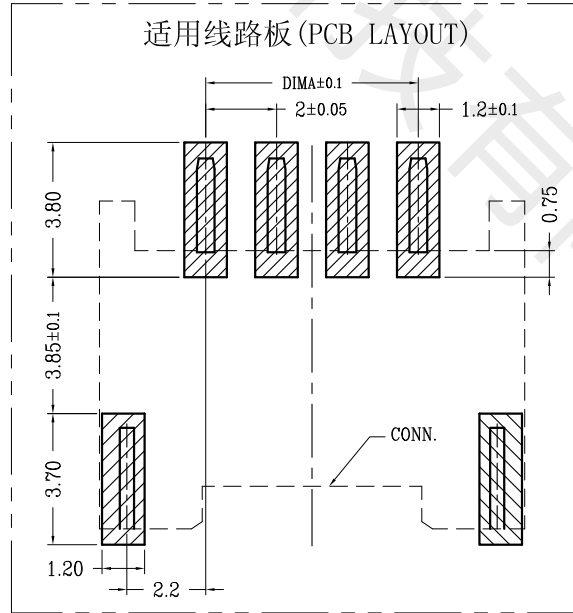

2 PIN 结构样式
(Structural style)

3 PIN 结构样式
(Structural style)



一般公差 (TOLERANCE)
X ±0.50 .XX ±0.10
X ±0.20 .XXX ±0.05
ANGLES ±1°

首韩 SHOUHAN 深圳市首韩科技有限公司

品名 (TITLE)	针座		制图 (DR)	李春风
料号 (DWG.NO)	2.0-5P WTDK		校对 (CHKD)	钟华华
比例 (SCALE)	1:1	单位 (UNITS)	mm	审核 (APPD)
张数 (SHEET)	1 OF 1	尺寸 (SIZE)	A4	罗孝金



深圳市首韩科技有限公司
SHENZHEN SHOUHAN TECHNOLOGY CO., LTD
Tel: 0755-27597601 Fax: 0755-27597491

承 认 书
SPECIFICATION FOR APPROVAL

客 户 Customer:

产品名称 Project:

针座

规格型号 Part No:

2.0-5P WTDK

贵公司承认印 Approval signatures

料 号/Part No.	签 章/Signatures

日期 Date:

拟制/Drawn	李春风	
审核/Check	钟华华	
批准/Approved	罗孝金	

1、SCOPE: (适用范围)

1.1 This specification covers production and inspection of Connector.

本规范内容适用于本公司普通系列型条形连接器（针座）产品的生产与检验。

2、USE CONDITION: (使用条件)

2.1 Ambient temperature Range:-25℃~+105℃

环境温度：-40℃~+85℃

2.2 Applicable Wire Sizes:AWG#28~#32

适用线规：AWG#28~#32

2.3 Applicable PC board thickness:0.6~1.2mm

适用PC板厚度：0.6~1.2mm

3、Appearance and Dimension: (外观及尺寸)

3.1 Appearance:Product surface without defect、dirt、crack、and mechanical damang, Contact without rust,plating not oxidized and not peeled.

产品表面不应有对制品有害的缺陷、污垢、裂痕及机械损伤；接触件无锈蚀、镀层氧化、脱落等现象。

3.2 Dimension:According to drawings

外形尺寸：依照附图

3.3 Exchangable:Exchangable with same specification products.

互换性：相同规格应能互换

4、Material: (以图纸要求为准)

材 料

P/N 零件名称	Type 类 型	Material 材 料	Finish 表面处理	Explain 说 明
Terminal 端子	Contact 插 簧	Phosphor bronze 锡青磷铜 厚 0.15mm	Tin Plating:3~4 μ m 镀锡: 3~4 μ m	RoHS Compliant
Housing 孔 座	Plastic 塑 壳	Nylon66 UL94V-0	Color:White 颜色: 白色	
Opening Wafer 开口针座	Contact 插 针	Phosphor bronze 锡青磷铜 厚 0.30mm	Tin Plating:3~4 μ m 镀锡: 3~4 μ m	
	Plastic 塑 壳	Nylon46 UL94V-0	Color: Beige 颜色: 米色	
Lips Wafer 闭口针座	Contact 插 针	Phosphor bronze 锡青磷铜 厚 0.30mm	Gold Plating:3~4 μ " m 镀金: 3~4 μ " m	
	Plastic 塑 壳	PBT UL94V-0	Color: White 颜色: 白色	
Tiepian Wafer 卧贴针座 立贴针座	Contact 插 针	Phosphor bronze 锡青磷铜 厚 0.30mm	Tin Plating:3~4 μ m 镀锡: 3~4 μ m	
	Solder tabs 焊护耳	Phosphor bronze 锡青磷铜 厚 0.25mm	Tin Plating:3~4 μ m 镀锡: 3~4 μ m	
	Plastic 塑 壳	Nylon46 UL94V-0	Color: Beige 颜色: 米色	

5、Electrical Performance:

电气性能

N0. 序号	Ltem 项目	Requirement 技术要求
5.1	Voltage Rated 额定电压	100V AC DC
5.2	Current Rated 额定电流	2A AC DC
5.3	Contact Resistance 接触电阻	$\leq 55 \text{ m}\Omega$
5.4	Insulation Resistance 绝缘电阻	$\geq 1000 \text{ M}\Omega$
5.5	Dielectric Strength 耐压	$\geq 200\text{V AC/minute}$

6、Mechanical Performance:

机械性能

N0. 序号	Ltem 项目	Requirement 技术要求
6.1	Male contact Retention force PIN 针固定力	$\geq 15\text{N}$ per pin
6.2	Female contact Retention force 端子固定力	$\geq 15\text{N}$ per pin
6.3	Plug-in force 插入力	$\leq 3\text{N}$ per pin
6.4	Plug-out force 拔出力	$\geq 0.5\text{N}$ per pin

7、Endurance Characteristics:

环境性能

N0. 序号	Ltem 项目	Requirement 技术要求
7.1	Soldering rest 可焊性	Time: $2.5 \pm 0.5\text{S}$ 时间: $2.5 \pm 0.5\text{S}$ Temperature: $260 \pm 5^\circ\text{C}$ 温度: $260 \pm 5^\circ\text{C}$ Area of Soldering: $\geq 95\%$ 焊锡面积: $\geq 95\%$

7.2	Resistance to soldering Heat 耐焊接热	<p>Time: 5 ± 1S 时间: 5 ± 1S</p> <p>Temperature: 260 ± 5°C 温度: 260 ± 5°C</p> <p>Appearance: NO Damage 外观: 无损坏</p>
7.3	Heat test 耐热性	<p>Time: 96h 时间: 96 小时</p> <p>Temperature: +85 ± 3°C 温度: +85 ± 3°C</p> <p>Appearance: NO Damage 外观: 无损坏</p> <p>Contact resistance: ≤ 20 mΩ 接触电阻: ≤ 20 mΩ</p>
7.4	Cold test 耐冷性	<p>Time: 48h 时间: 48 小时</p> <p>Temperature: -25 ± 3°C 温度: -25 ± 3°C</p> <p>Appearance: NO Damage 外观: 无损坏</p> <p>Contact resistance: ≤ 20 mΩ 接触电阻: ≤ 20 mΩ</p>
7.5	Temperature Cycling 温度循环	<p>Low temperature: -25 ± 3°C 低温: -25 ± 3°C</p> <p>High temperature: 85 ± 3°C 高温: 85 ± 3°C</p> <p>For 5 cycles. test after keeping in Normal Condition for 30 min. 5 次循环后, 放置在正常环境中 30 分钟, 在进行测试</p> <p>Appearance: NO Damage 外观: 无损坏</p> <p>Contact resistance: ≤ 20 mΩ 接触电阻: ≤ 20 mΩ</p>

7.6	Invariab lenes humidity 恒定湿热	<p>Temperature: $60 \pm 2^{\circ}\text{C}$ 温度: $60 \pm 2^{\circ}\text{C}$</p> <p>Relative humidity: 90%-96% RH 相对湿度: 90%-96% RH</p> <p>Tim: 96h 时间: 96 小时</p> <p>Appearance: NO Damage 外观: 无损坏</p> <p>Contact resistance: $\leq 20 \text{ m}\Omega$ 接触电阻: $\leq 20 \text{ m}\Omega$</p> <p>Insulation Resistance: $\geq 100 \text{ M}\Omega$ 绝缘电阻: $\geq 100 \text{ M}\Omega$</p>
7.7	Salt Spray 盐雾试验	<p>Salt concentration: $5 \pm 1\%$ 浓度: $5 \pm 1\%$</p> <p>Temperature: $35 \pm 2^{\circ}\text{C}$ 温度: $35 \pm 2^{\circ}\text{C}$</p> <p>Tim: $16 \pm 2\text{h}$ 时间: 16 ± 2 小时</p> <p>After salt is removed by running wafer and A drop is removed ,it is measured.</p> <p>把试验样品从试验箱顶悬挂下来,采用浓度 (5 ± 1) %的氯化钠溶液,连续雾化 16 小时,试验后用流动的蒸馏水轻轻洗去表面沉积物,在常温常驻湿条件下恢复 1-2 小时,外观无损伤</p> <p>Appearance: NO Damage 外观: 无损坏</p> <p>Contact resistance: $\leq 20 \text{ m}\Omega$ 接触电阻: $\leq 20 \text{ m}\Omega$</p>

8、Packaging Transportation Storage

包装、运输、贮存

8.1 Packaging

包装

- (1) **The packing of plastic inner is the plastic bag,the packing of inner terminal is panel mounting attach material packing, marked with product name, specification model, quantity, date in produced.**

塑件内包装为塑料袋，端子内包装为盘装带料包装，装（贴）入合格证，注明产品名称、规格型号、数量生产日期

- (2) **Exterior package is carton, facing the packing list, the packing list marked with product name, specification model, quantity, date of dispatch.**

外包装为纸箱，贴装箱单、装箱单上注明产品名称、规格型号、数量、出货日期

- (3) **The product in the box must not rock.**

产品在箱内不晃动

8.2 Transportation

运输

Allow for any way transportation, can't get wet and mechanical in jury.

允许用任何方式运输，勿淋湿及机械性损伤

8.3 Storage

贮存

The connector of packing finished should be in the ambient temperature between-10℃ to+40℃, Relative humidity≤80%. To store in storehouse does not have acidic, alkaline air and other corrosive gas in the ambient air.

包装完毕的连接器应在环境温度为-10℃~+40℃，相对湿度≤80%，周围空气中没有酸性，碱性及其它腐蚀性气体的库房中贮存