

KYL3401

30V P-Channel Mosfet

FEATURES

- $R_{DS(ON)} \leq 60m\Omega$ (48m Ω Typ.)
@ $V_{GS}=-10V$
- $R_{DS(ON)} \leq 78m\Omega$ (57m Ω Typ.)
@ $V_{GS}=-4.5V$
- $R_{DS(ON)} \leq 112m\Omega$ (77m Ω Typ.)
@ $V_{GS}=-2.5V$

SOT-23-3L

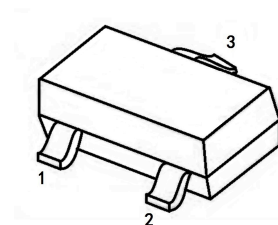

1. GATE
2. SOURCE
3. DRAIN

APPLICATIONS

- Load Switch
- PWM Applications
- Power Management

MARKING

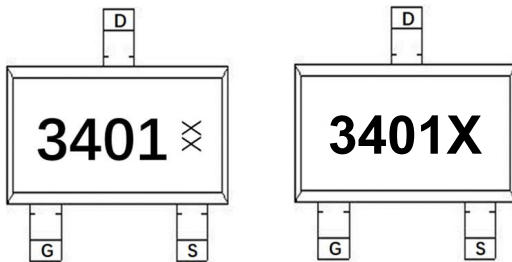

X: Date Code

Other marks: "X1YV" = "

P-CHANNEL MOSFET

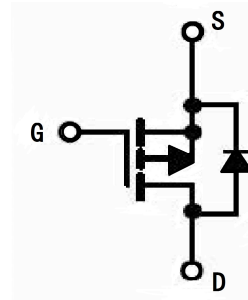

MAXIMUM RATINGS (Ta=25°C unless otherwise noted)

Symbol	Parameter	Max.	Units
V_{DSS}	Drain-Source Voltage	-30	V
V_{GSS}	Gate-Source Voltage	± 12	V
I_D	Continuous Drain Current	$T_a = 25^\circ C$	-4.2
		$T_a = 100^\circ C$	-2.7
I_{DM}	Pulsed Drain Current ^{note1}	-30	A
P_D	Power Dissipation	1.7	W
$R_{\theta JA}$	Thermal Resistance, Junction to Ambient	76.2	$^\circ C/W$
T_J, T_{STG}	Operating and Storage Temperature Range	-55 to +150	$^\circ C$

MOSFET ELECTRICAL CHARACTERISTICS Ta=25 °C unless otherwise specified

Symbol	Parameter	Test Condition	Min.	Typ.	Max.	Units
Off Characteristic						
$V_{(BR)DSS}$	Drain-Source Breakdown Voltage	$V_{GS}=0V, I_D=-250\mu A$	-30	-	-	V
I_{DSS}	Zero Gate Voltage Drain Current	$V_{DS}=-30V, V_{GS}=0V,$	-	-	-1.0	μA
I_{GSS}	Gate to Body Leakage Current	$V_{DS}=0V, V_{GS}= \pm 12V$	-	-	± 100	nA
On Characteristics						
$V_{GS(th)}$	Gate Threshold Voltage	$V_{DS}=V_{GS}, I_D=-250\mu A$	-0.6	-0.9	-1.3	V
$R_{DS(on)}$	Static Drain-Source on-Resistance <small>note2</small>	$V_{GS}= -10V, I_D= -4A$	-	48	60	m Ω
		$V_{GS}= -4.5V, I_D= -3A$	-	57	78	
		$V_{GS}= -2.5V, I_D= -1A$	-	77	112	
Dynamic Characteristics						
C_{iss}	Input Capacitance	$V_{DS}= -15V, V_{GS}=0V,$ $f=1.0MHz$	-	880	-	pF
C_{oss}	Output Capacitance		-	105	-	pF
C_{riss}	Reverse Transfer Capacitance		-	65	-	pF
Q_g	Total Gate Charge	$V_{DS}= -15V, I_D= -4.2A,$ $V_{GS}= -10V$	-	8.5	-	nC
Q_{gs}	Gate-Source Charge		-	1.8	-	nC
Q_{gd}	Gate-Drain("Miller") Charge		-	2.7	-	nC
Switching Characteristics						
$t_{d(on)}$	Turn-on Delay Time	$V_{DD}= -15V, I_D= -1A,$ $V_{GS}= -10V, R_{GEN}=2.5\Omega$	-	7	-	ns
t_r	Turn-on Rise Time		-	3	-	ns
$t_{d(off)}$	Turn-off Delay Time		-	20	-	ns
t_f	Turn-off Fall Time		-	12	-	ns
Drain-Source Diode Characteristics and Maximum Ratings						
I_S	Maximum Continuous Drain to Source Diode Forward Current		-	-	-4.2	A
I_{SM}	Maximum Pulsed Drain to Source Diode Forward Current		-	-	-30	A
V_{SD}	Drain to Source Diode Forward Voltage	$V_{GS}=0V, I_S=-4.2A$	-	-0.8	-1.2	V

Notes:1. Repetitive Rating: Pulse Width Limited by Maximum Junction Temperature

2. Pulse Test: Pulse Width $\leq 300\mu s$, Duty Cycle $\leq 2\%$

TYPICAL PERFORMANCE CHARACTERISTICS

Figure 1: Output Characteristics

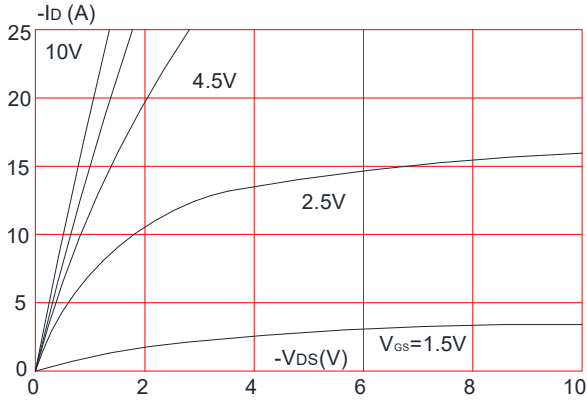

Figure 2: Typical Transfer Characteristics

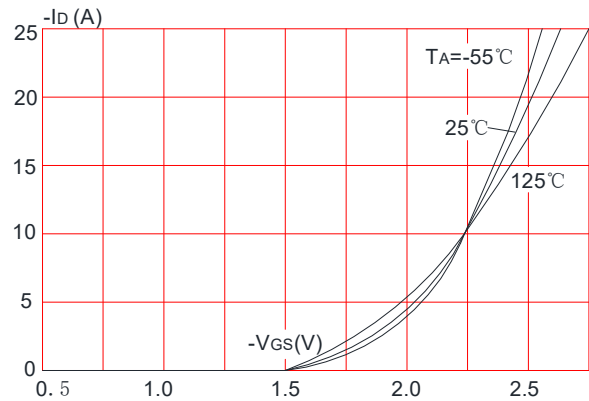

Figure 3: On-resistance vs. Drain Current

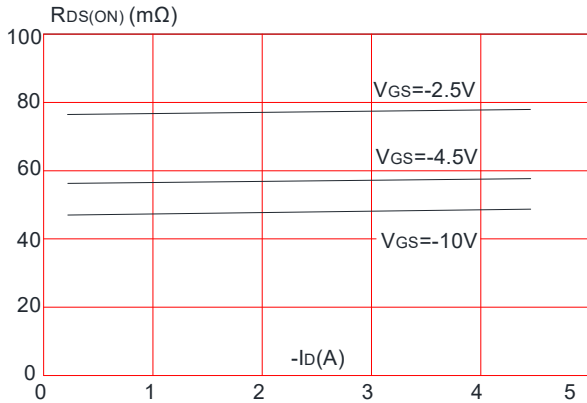

Figure 4: Body Diode Characteristics

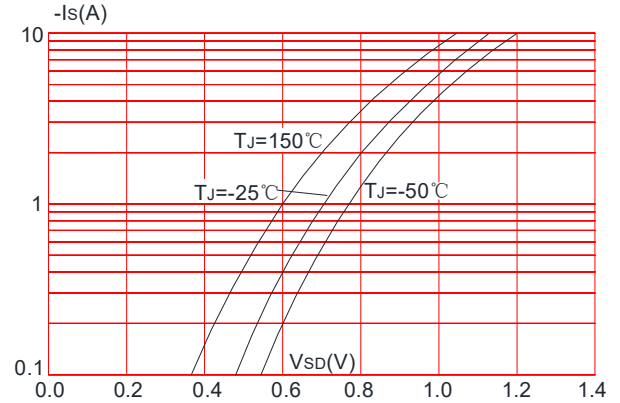

Figure 5: Gate Charge Characteristics

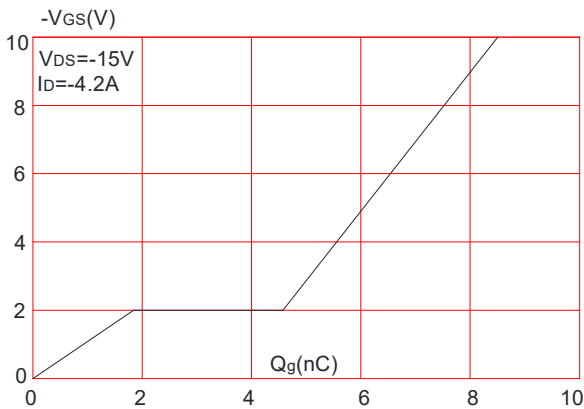
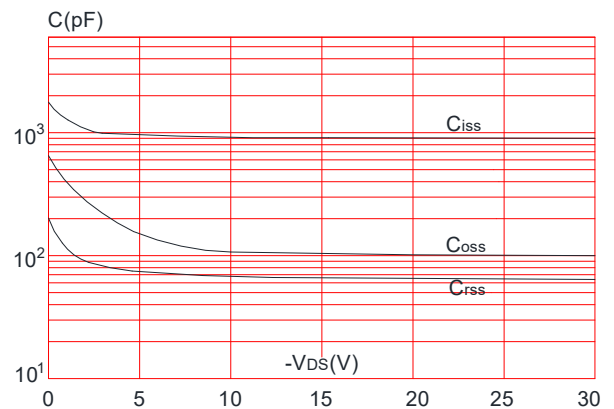

Figure 6: Capacitance Characteristics



TYPICAL PERFORMANCE CHARACTERISTICS (cont.)

Figure 7: Normalized Breakdown Voltage vs. Junction Temperature

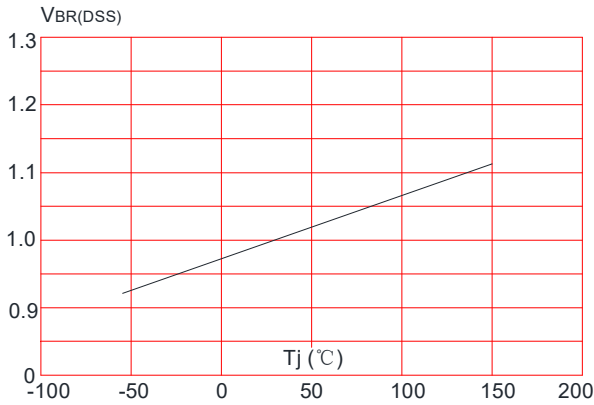

Figure 8: Normalized on Resistance vs. Junction Temperature

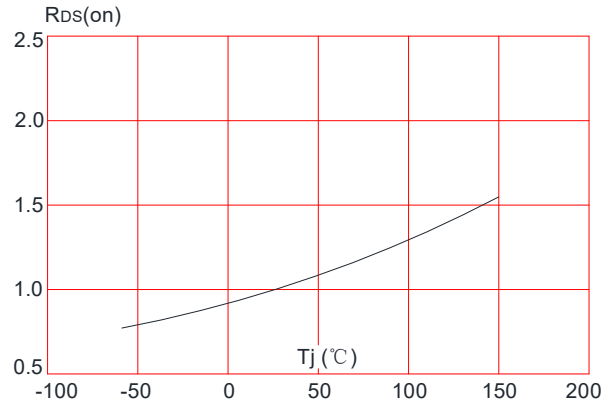

Figure 9: Maximum Safe Operating Area

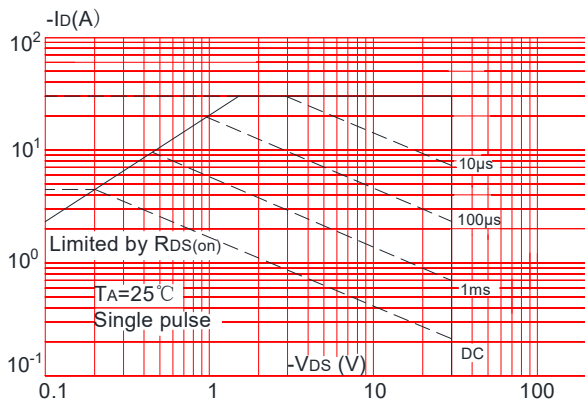

Figure 10: Maximum Continuous Drain Current vs. Ambient Temperature

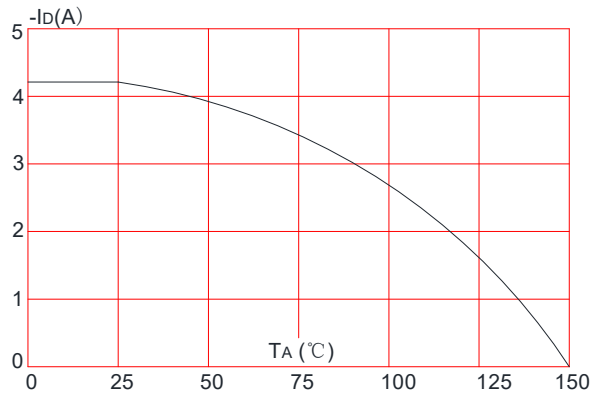
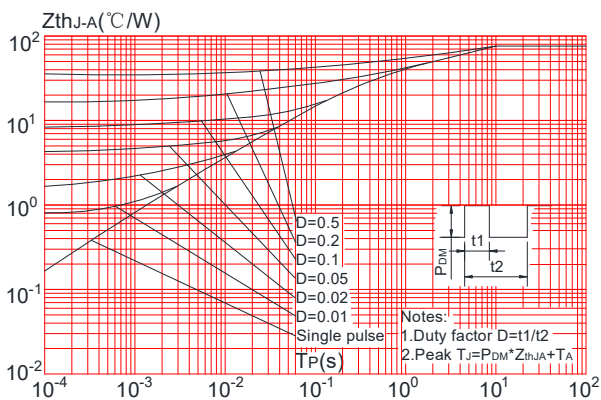
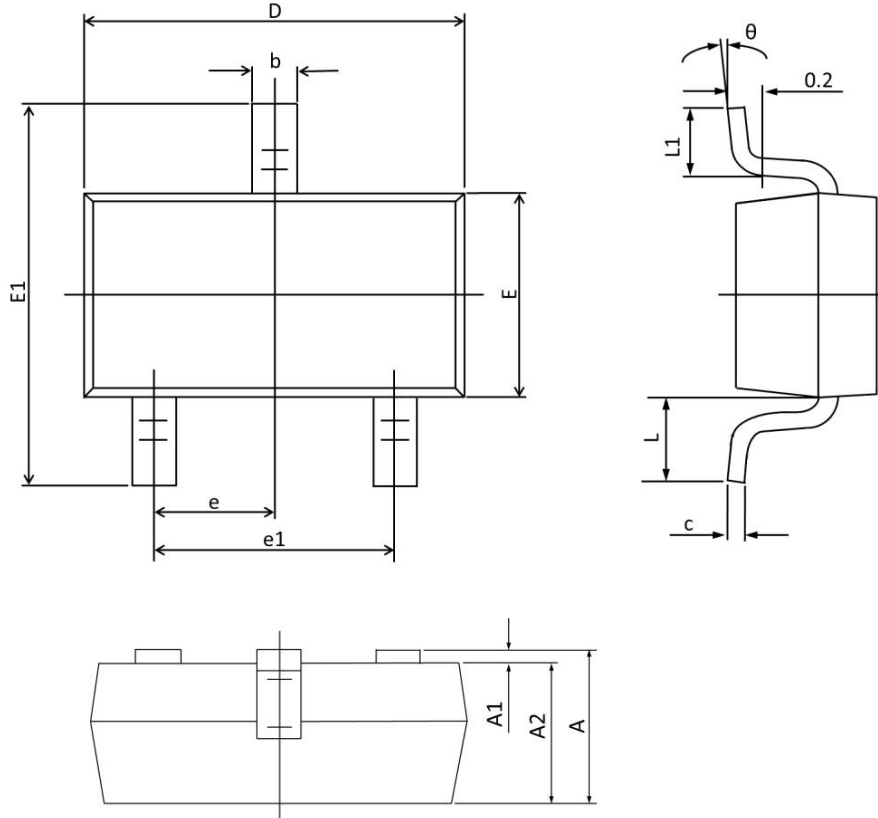

Figure.11: Maximum Effective Transient Thermal Impedance, Junction-to-Ambient



SOT-23-3L PACKAGE OUTLINE DRAWING

Symbol	Dimensions In Millimeters		Dimensions In Inches	
	Min	Max	Min	Max
A	1.050	1.250	0.041	0.049
A1	0.000	0.100	0.000	0.004
A2	1.050	1.150	0.041	0.045
b	0.300	0.400	0.012	0.016
c	0.100	0.200	0.004	0.008
D	2.820	3.020	0.111	0.119
E	1.500	1.700	0.059	0.067
E1	2.650	2.950	0.104	0.116
e	0.950 TYP.		0.037 TYP.	
e1	1.800	2.000	0.071	0.079
L	0.700 REF.		0.028 REF.	
L1	0.300	0.600	0.012	0.024
θ	0°	8°	0°	8°