

KY2305A

-20V P-Channel Mosfet

FEATURES

- $R_{DS(ON)} \leq 45m\Omega$ (35m Ω Typ.)
@ $V_{GS}=-4.5V$
- $R_{DS(ON)} \leq 70m\Omega$ (38m Ω Typ.)
@ $V_{GS}=-2.5V$
- $R_{DS(ON)} \leq 90m\Omega$ (50m Ω Typ.)
@ $V_{GS}=-1.8V$

SOT-23

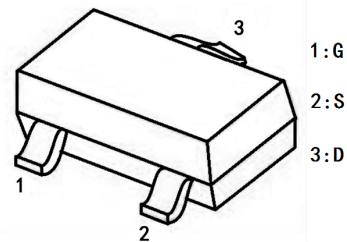

APPLICATIONS

- Load Switch for Portable Devices
- DC/DC Converter

MARKING

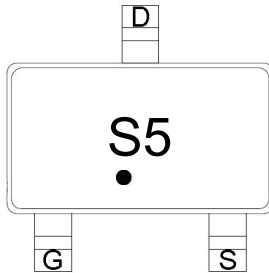

Other marks: "2305 " or " S5B. "

P-CHANNEL MOSFET

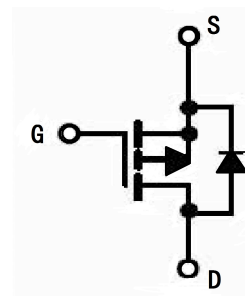

Maximum ratings (Ta=25°C unless otherwise noted)

| Symbol | Parameter | Value | Unit |
|-----------------|--|-----------|---------------|
| V_{DS} | Drain-Source Voltage | -20 | V |
| V_{GS} | Gate-Source Voltage | ± 12 | |
| I_D | Continuous Drain Current | -4.1 | A |
| I_{DM} | Pulsed Drain Current | -16 | |
| P_D | Maximum Power Dissipation | 0.83 | W |
| $R_{\theta JA}$ | Thermal Resistance from Junction to Ambient(t \leq 5s) | 150 | $^{\circ}C/W$ |
| T_J | Junction Temperature | 150 | $^{\circ}C$ |
| T_{stg} | Storage Temperature | -55 ~+150 | |

KY2305A

MOSFET ELECTRICAL CHARACTERISTICS $T_a=25\text{ }^\circ\text{C}$ unless otherwise specified

| Symbol | Parameter | Test Condition | Min | Typ | Max | Units |
|-------------------------------------|---|--|------|-------|-----------|------------|
| Static | | | | | | |
| $V_{(BR)DSS}$ | Drain-source breakdown voltage | $V_{GS} = 0V, I_D = -250\mu A$ | -20 | -21.5 | | V |
| $V_{GS(th)}$ | Gate-source threshold voltage | $V_{DS} = V_{GS}, I_D = -250\mu A$ | -0.4 | -0.7 | -1 | |
| I_{GSS} | Gate-source leakage | $V_{DS} = 0V, V_{GS} = \pm 10V$ | | | ± 100 | nA |
| I_{DSS} | Zero gate voltage drain current | $V_{DS} = -16V, V_{GS} = 0V$ | | | -1 | μA |
| $R_{DS(on)}$ | Drain-source on-state resistance <small>note1</small> | $V_{GS} = -4.5V, I_D = -3.5A$ | | 35 | 45 | m Ω |
| | | $V_{GS} = -2.5V, I_D = -3A$ | | 38 | 70 | |
| | | $V_{GS} = -1.8V, I_D = -2A$ | | 50 | 90 | |
| V_{SD} | Body diode voltage | $I_S = -3.3A$ | | -0.9 | -1.2 | V |
| Dynamic <small>note2</small> | | | | | | |
| C_{iss} | Input capacitance | $V_{DS} = -4V, V_{GS} = 0V, f = 1MHz$ | | 740 | | pF |
| C_{oss} | Output capacitance | | | 290 | | |
| C_{rss} | Reverse transfer capacitance | | | 190 | | |
| Q_g | Total gate charge | $V_{DS} = -4V, V_{GS} = -2.5V$ $I_D = -4.1A$ | | 4.5 | 9 | nC |
| Q_{gs} | Gate-source charge | | | 1.2 | | |
| Q_{gd} | Gate-drain charge | | | 1.6 | | |
| $t_{d(on)}$ | Turn-on delay time | $V_{DS} = -4V,$ $R_L = 1.2\Omega, I_D = -3.3A,$ $V_{GEN} = -4.5V, R_G = 1\Omega$ | | 13 | 20 | nS |
| t_r | Rise time | | | 35 | 53 | |
| $t_{d(off)}$ | Turn-off delay time | | | 32 | 48 | |
| t_f | Fall time | | | 10 | 20 | |

Notes: 1. Pulse Test : Pulse Width < 300 μs , Duty Cycle $\leq 2\%$.

2 . Guaranteed by design, not subject to production testing.

Typical Performance Characteristics

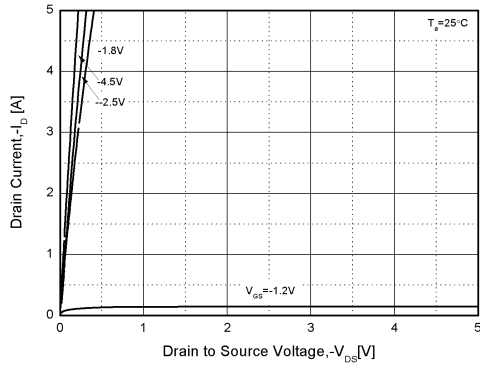

Figure1. Output Characteristics

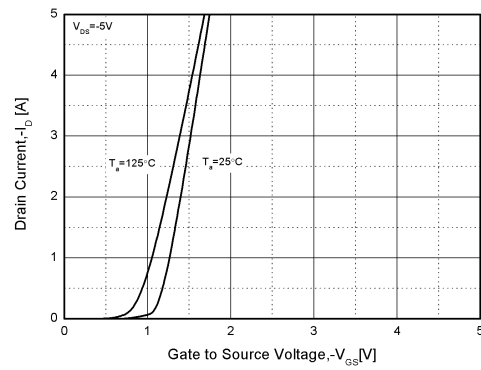

Figure2. Transfer Characteristics

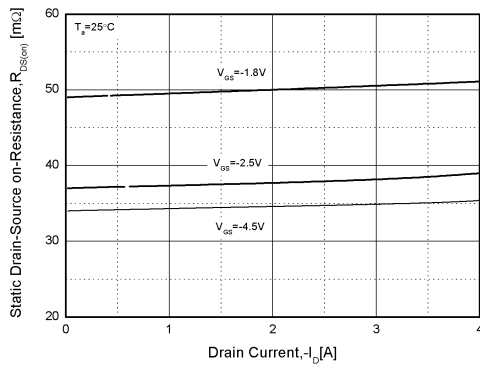

Figure3. Rdson-Drain Current

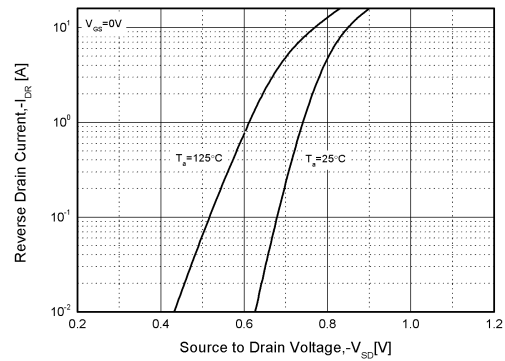

Figure4. Typical Source-Drain Diode Forward Voltage

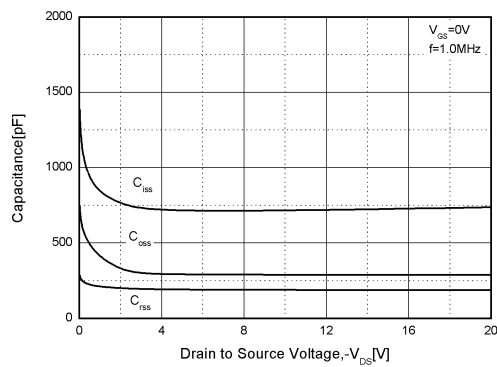

Figure5. Capacitance Characteristics

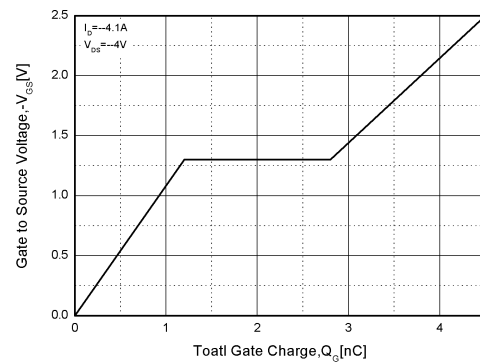

Figure6. Gate Charge

Typical Performance Characteristics (cont.)

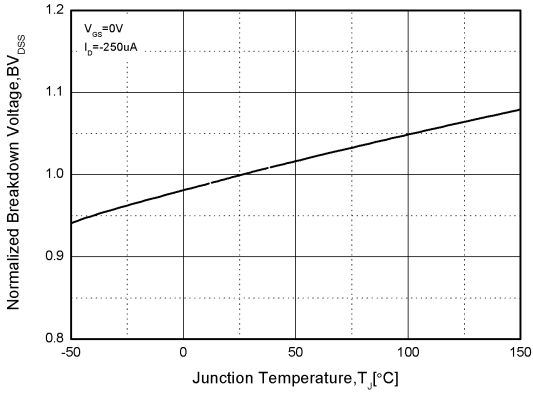

Figure7. Normalized Breakdown Voltage vs. Temperature

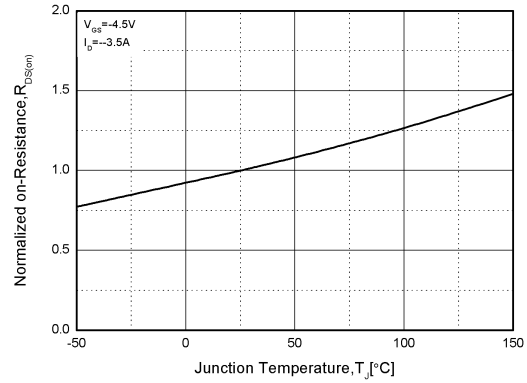

Figure8. Normalized on Resistance vs. Temperature

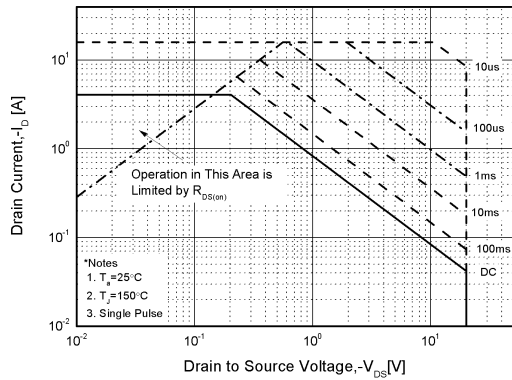

Figure9. Safe Operation Area

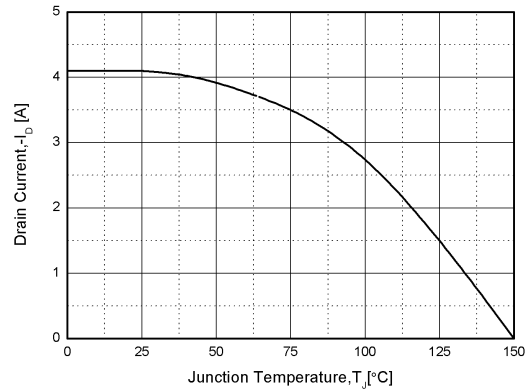
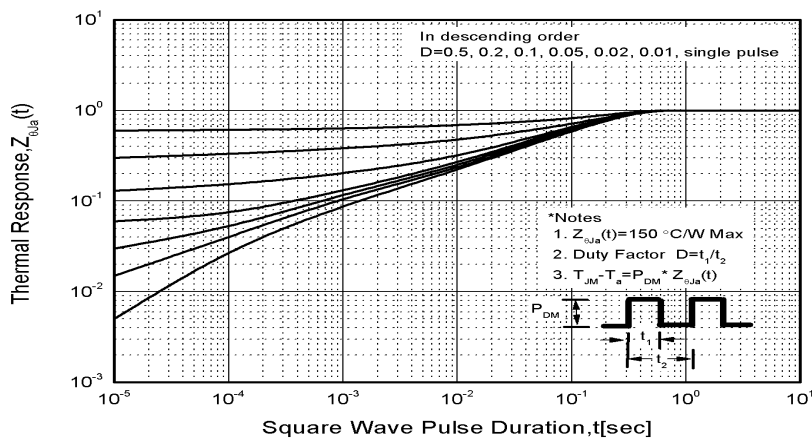
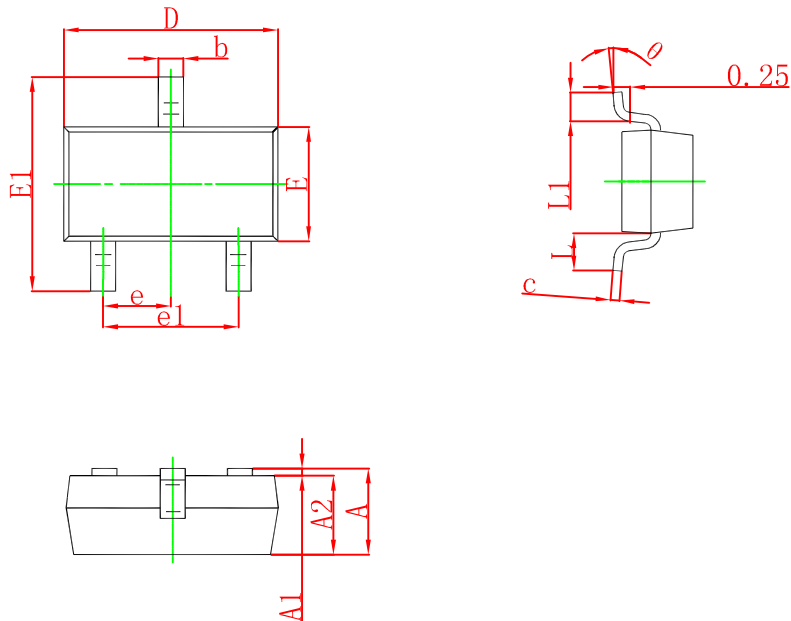

Figure10. Drain Current vs. Case Temperature



SOT-23 Package Outline Dimensions

| Symbol | Dimensions In Millimeters | | Dimensions In Inches | |
|--------|---------------------------|-------|----------------------|-------|
| | Min | Max | Min | Max |
| A | 0.900 | 1.150 | 0.035 | 0.045 |
| A1 | 0.000 | 0.100 | 0.000 | 0.004 |
| A2 | 0.900 | 1.050 | 0.035 | 0.041 |
| b | 0.300 | 0.500 | 0.012 | 0.020 |
| c | 0.080 | 0.150 | 0.003 | 0.006 |
| D | 2.800 | 3.000 | 0.110 | 0.118 |
| E | 1.200 | 1.400 | 0.047 | 0.055 |
| E1 | 2.250 | 2.550 | 0.089 | 0.100 |
| e | 0.950 TYP | | 0.037 TYP | |
| e1 | 1.800 | 2.000 | 0.071 | 0.079 |
| L | 0.550 REF | | 0.022 REF | |
| L1 | 0.300 | 0.500 | 0.012 | 0.020 |
| θ | 0° | 8° | 0° | 8° |

KY2305A

SOT-23 Embossed Carrier Tape

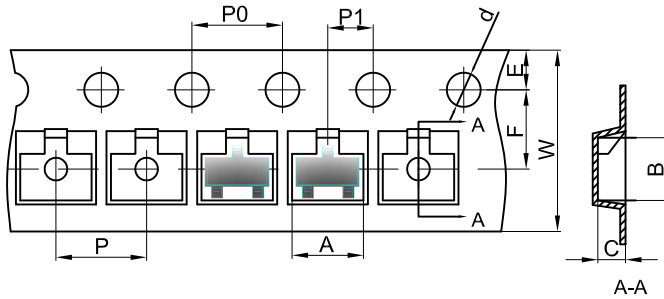

Dimensions are in millimeter

| Pkg type | A | B | C | d | E | F | P0 | P | P1 | W |
|----------|------|------|------|-------|------|------|------|------|------|------|
| SOT-23 | 3.15 | 2.77 | 1.22 | Ø1.50 | 1.75 | 3.50 | 4.00 | 4.00 | 2.00 | 8.00 |

SOT-23 Tape Leader and Trailer

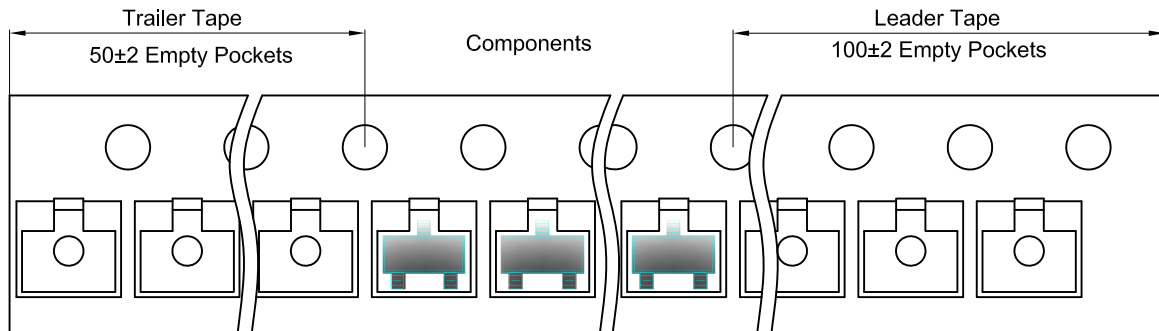

SOT-23 Reel

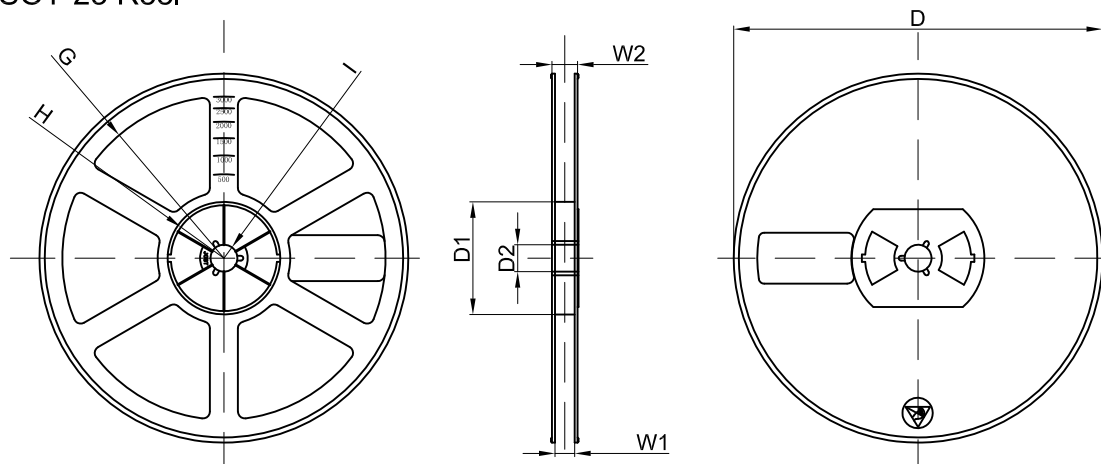

Dimensions are in millimeter

| Reel Option | D | D1 | D2 | G | H | I | W1 | W2 |
|-------------|---------|-------|-------|--------|--------|-------|------|-------|
| 7" Dia | Ø178.00 | 54.40 | 13.00 | R78.00 | R25.60 | R6.50 | 9.50 | 12.30 |

| REEL | Reel Size | Box | Box Size(mm) | Carton | Carton Size(mm) | G.W.(kg) |
|----------|-----------|------------|--------------|-------------|-----------------|----------|
| 3000 pcs | 7 inch | 45,000 pcs | 203×203×195 | 180,000 pcs | 438×438×220 | |