

# SPECIFICATION

SPEC. No. C513NAA00413 ISSUE 1

DATE: March 3, 2016

Messrs.,

**NAN JING TRYBEST  
ELECTRONICS CO.,LTD**

Compliant with AEC Q-200

CUSTOMER'S PRODUCT NAME

TDK'S PRODUCT NAME

CLF7045NIT-0000□-D

RECEIPT CONFIRMATION

DATE YEAR MONTH DAY

TDK Corporation

Sales  
Electronic Components  
Sales & Marketing Group

Engineering  
TDK Corporation  
Electronic Components Business Company  
Magnetics Business Group  
Wire-wound Products B.U.

APPROVED	Person in charge

APPROVED	CHECKED	Person in charge
H.Suzuki	K.Arimitsu	Y.Takanashi

# INSTRUCTIONS USING THIS PRODUCT

Please read the instructions here before you use this product.

## INSTRUCTIONS ON SEFETY

When use the products, be careful to mentioned below for safety using.



## CAUTION

### STORAGE

- + Store this product under the conditions which are defined in the catalogue or the instruction book.  
Confirm the soldering property before using if you have stored the product over the conditions
- +Don't store this product under the influence of the poisonous gases(such as hydrogen sulfide, sulfurous acid, chlorine and ammonia gas).
- +Avoid the direct rays of the sun and dew condensation.

### USING CONDITIONS

- +Use this product under the conditions which are defined in the catalogue or the instruction book.  
Temperature range and soldering property are especially to be noticed.
- +Don't use this product in the place
  - \*Exposed to water or seawater.
  - \*With dew condensation.
  - \*Under the influence of the poisonous gases (such as hydrogen sulfide, Sulfurous acid, chlorine and ammonia gas).
  - \*With vibrations and impulses which are not defined in the instruction book.
- +The products must be preheated before soldering.  
Difference between preheat and soldering temperature must be within 150deg.C.
- +When soldering is modified after it is located on a base plate , you should confirm the conditions which are defined in the catalogue or the instruction book.  
If it is heated excessively, the product may have troubles such as short circuit, rough contact , lowering of a property and shortening of its tenure.
- +Don't use the product if it is mechanically impacted by dropping and so on.
- +In case of insert P.C. Board on chassis, do not add mechanical stress to the product.
- +The product has self heat (temperature rise) by current, so keep margin for heat design.
- +Be careful to arrange of non-magnetic shield type inductors. The error may be caused by magnetic field coupling.
- +In case handle the products, please use wrist strap for ground static discharge on human body.  
The product keeps away from magnet or magnetized things.
- +If any coating material is used to this product, please have enough examination before use.

### APPLICATION

The products listed on this specification sheet are intended for use in general electronic equipment (AV equipment, telecommunications equipment, home appliances, amusement equipment, computer equipment, personal equipment, office equipment, measurement equipment, industrial robots) under a normal operation and use condition.

The products are not designed or warranted to meet the requirements of the applications listed below, whose performance and/or quality require a more stringent level of safety or reliability, or whose failure, malfunction or trouble could cause serious damage to society, person or property. Please understand that we are not responsible for any damage or liability caused by use of the products in any of the applications below or for any other use exceeding the range or conditions set forth in this specification sheet.

- |   |   |
|---|---|
| 1) Aerospace/Aviation equipment                           | 6) Transportation control equipment   |
| 2)Medical equipment<br>which directly endanger human life | 7) Military equipment   |
| 3) Power-generation control equipment                     | 8) Safety equipment   |
| 4) Atomic energy-related equipment                        | 9) Other applications that are not considered<br>general-purpose applications |
| 5) Seabed equipment                                       |   |

If you intend to use the products in the following applications, please contact our sales office.  
Transportation equipment (cars, electric trains, ships, etc.) , Public information-processing equipment,  
Electric heating apparatus / burning equipment , Disaster prevention/crime prevention equipment  
When using this product in general-purpose applications, you are kindly requested to take into consideration  
securing protection circuit/equipment or providing backup circuits, etc., to ensure higher safety.

TDK Corporation

DWG No.

C513NAA00413

ISSUE

1

PAGE

1/8

Scope

This specifications applies to POWER INDUCTOR

CLF7045NI-D series to be delivered to

NAN JING TRYBEST ELECTRONICS CO.,LTD

Product indemnification

CLF7045NI    T - ○○○    □ - D  
(1)            (2)            (3)            (4)            (5)

(1)Series name

(2)Packaging style designation / T:Taping (φ330mm reel)

(3)Inductance / 1R0: 1.0[uH] , 100: 10[uH] , 101: 100[uH]

(4)Inductance tolerance / M: ±20% , N: ±30%

(5)Control number

Mentioned item

- 1.Shapes and dimension and an equivalent circuit
- 2.Electrical characteristics
- 3.Storage temperature range
- 4.Operating temperature range
- 5.Structure and used material
- 6.Reliability test
- 7.Recommended footprint
- 8.Recommended soldering conditions
- 9.Packaging
- 10.Attentin in case of using
- 11.Packaging form

Other

In case any matter other than stated in this specification should take place, it shall be decided upon on a case by case basis.

Please return a copy of this specification document with your signature to us within 2 months after this document is issued.

If a copy of this document with your signature is not received within the above mentioned period after its issue date, the product specification will be deemed to have been accepted by you.

Change history

No.	DATE	DRAWN	CHANGE ITEM

1.Shapes and dimension and an equivalent circuit

<Shapes and dimension>

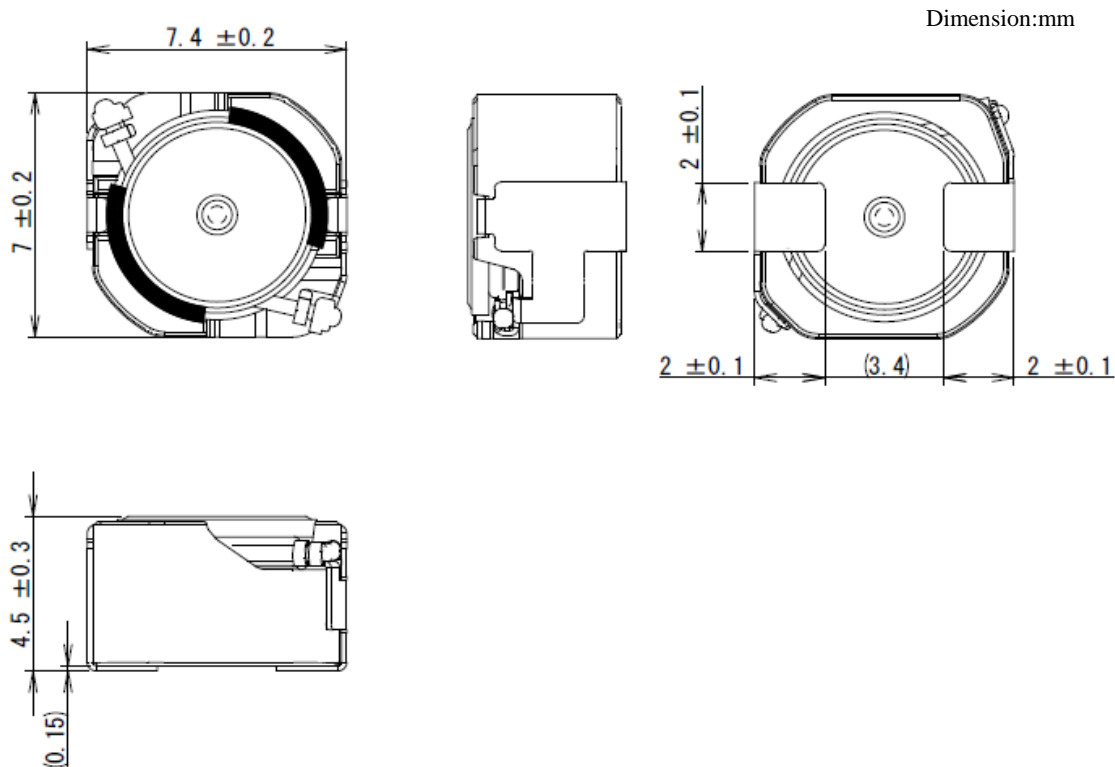

<Marking specification>

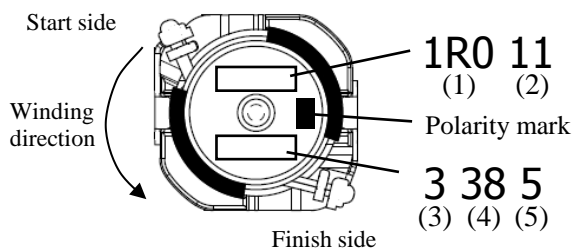

- (1)Inductance:(1R0 : 1.0uH, 100:10uH, 101:100uH)
- (2)Serial No.
- (3)Year:(2014:4, 2020:0)
- (4)Week:(CW38 : 38)
- (5)day:(0:Sun, 1:Mon, 2:Tue, 3:Wed, 4:Thu, 5:Fri, 6:Sat)

<Equivalent circuit>

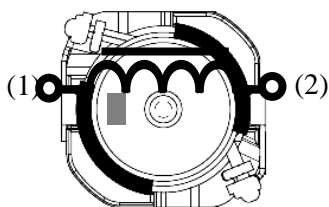

<Polarity>

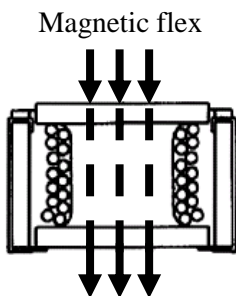

If you have a high potential terminal side polarity mark  
Magnetic flux flows to the mounting surface (PCB side)  
from top side (marking surface).

## 2. Electrical characteristics

### 2-1. Electrical spec.

Part number	Our product Part number	Inductance(uH) at100kHz	DC resistance( $\Omega$ )	Isat(A)		Itemp(A)	Marking
				min.	typ.		
	CLF7045NIT-1R0N-D	1.0 $\pm$ 30%	0.009 $\pm$ 30%	8.5	11.0	6.5	1R0
	CLF7045NIT-1R5N-D	1.5 $\pm$ 30%	0.010 $\pm$ 30%	6.3	8.6	5.4	1R5
	CLF7045NIT-2R2N-D	2.2 $\pm$ 30%	0.013 $\pm$ 30%	6.2	6.3	5.1	2R2
	CLF7045NIT-3R3N-D	3.3 $\pm$ 30%	0.016 $\pm$ 30%	4.7	6.0	4.8	3R3
	CLF7045NIT-4R7N-D	4.7 $\pm$ 30%	0.018 $\pm$ 30%	4.1	4.8	4.1	4R7
	CLF7045NIT-6R8N-D	6.8 $\pm$ 30%	0.022 $\pm$ 30%	3.1	4.1	3.9	6R8
	CLF7045NIT-100M-D	10 $\pm$ 20%	0.033 $\pm$ 20%	3.0	3.4	3.1	100
	CLF7045NIT-150M-D	15 $\pm$ 20%	0.055 $\pm$ 20%	2.3	2.8	2.6	150
	CLF7045NIT-220M-D	22 $\pm$ 20%	0.069 $\pm$ 20%	1.7	2.4	2.2	220
	CLF7045NIT-330M-D	33 $\pm$ 20%	0.097 $\pm$ 20%	1.6	1.9	1.8	330
	CLF7045NIT-470M-D	47 $\pm$ 20%	0.130 $\pm$ 20%	1.26	1.6	1.7	470
	CLF7045NIT-680M-D	68 $\pm$ 20%	0.170 $\pm$ 20%	1.08	1.3	1.5	680
	CLF7045NIT-101M-D	100 $\pm$ 20%	0.260 $\pm$ 20%	0.81	1.1	1.05	101
	CLF7045NIT-151M-D	150 $\pm$ 20%	0.430 $\pm$ 20%	0.69	0.89	0.95	151
	CLF7045NIT-221M-D	220 $\pm$ 20%	0.550 $\pm$ 20%	0.56	0.71	0.75	221
	CLF7045NIT-331M-D	330 $\pm$ 20%	0.800 $\pm$ 20%	0.50	0.60	0.58	331
	CLF7045NIT-471M-D	470 $\pm$ 20%	1.200 $\pm$ 20%	0.41	0.50	0.46	471

Isat: Depends on the inductance saturation. (-30% decrease from nominal L value)

Itemp: Depends on the self temperature rise (+40°C typ.)

### 2-2. Measuring machine and Test equipment

#### (1) Inductance

Measured by Agilent4285A or equivalent between 2 terminals.

#### (2) DC resistance

Measured by ADEX AX-114N or equivalent between 2 terminals.

### 3. Storage temperature range

Store this product under the condition of 5 to 40°C, 20 to 75%RH and use within 12 months.

### 4. Operating temperature range

#### 4-1. Condition for storage after mounting.

-55°C to +150°C

#### 4-2. Condition for operating after mounting.

-55°C to +150°C (including self temperature rise)

### 5. Structure and used material

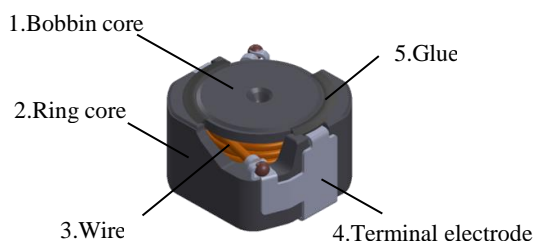

No.	Item	Material
1	Bobbin core	Ferrite core
2	Ring core	Ferrite core
3	Wire	Polyamide imide wire
4	Terminal electrode	Cu+Ni+Sn
5	Glue	Epoxy resin

## 6. Reliability test

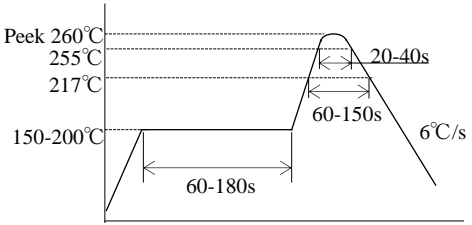
Item	Specifications	Test conditions
Solder ability	The product shall be connected to the test circuit board by the fillet.	Apply cream solder to the printed circuit board. Refer to clause 8 for Reflow profile.
Soldering heat resistance	$\Delta L/L0 \leq \pm 5\%$ There shall be no mechanical damages.	Apply cream solder to the printed circuit board. *Reflow profile                      Reflow: until 2 times 
Terminal strength	There shall be no mechanical damages.	Solder a chip to test substrate, and then laterally apply a load 17.7N.
Strength on PCB bending	There shall be no mechanical damages.	Solder a chip to test substrate, and then laterally apply a load 2mm Test board: t1.6mm
Thermal shock	$\Delta L/L0 \leq \pm 5\%$ There shall be no mechanical damages.	After the samples shall be soldered onto the test circuit board, the test shall be done. Measurement: After placing for 24 hours min. Temp.: -55~150°C each 30 min. Testing time: 1000 cycles
High temperature storage	$\Delta L/L0 \leq \pm 5\%$ There shall be no mechanical damages.	After the samples shall be soldered onto the test circuit board, the test shall be done. Measurement: After placing for 24 hours min. Temp.: 150±2°C Testing time: 1000±12 hours
Biased humidity	$\Delta L/L0 \leq \pm 5\%$ There shall be no mechanical damages.	After the samples shall be soldered onto the test circuit board, the test shall be done. Measurement: After placing for 24 hours min. Temp: 85±2°C, Humidity: 83~87% RH Testing time: 1000±12 hours
Low temperature storage	$\Delta L/L0 \leq \pm 5\%$ There shall be no mechanical damages.	After the samples shall be soldered onto the test circuit board, the test shall be done. Measurement: After placing for 24 hours min. Temp.: -55±2°C Testing time: 1000±12 hours
Vibration	$\Delta L/L0 \leq \pm 5\%$ There shall be no mechanical damages.	After the samples shall be soldered onto the test circuit board, the test shall be done. Freq.: 10~2000Hz    Amplitude: 100m/s <sup>2</sup> or 1.5mmP-P Dimension and time: X, Y and Z directions for 48 hours each. Total 144 hours.
Mechanical shock	$\Delta L/L0 \leq \pm 5\%$ There shall be no mechanical damages.	After the samples shall be soldered onto the test circuit board, the test shall be done. Acceleration: 1000m/s <sup>2</sup> Duration: 6ms Direction and Number of time : X, Y, Z, X', Y', Z' each 3 times. Total 18 times.

7.Recommended footprint

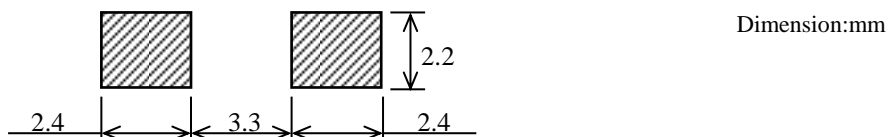

8.Recommended soldering conditions (Please use this product by reflow soldering)

8-1.Profile for Pb-free solder

8-2.Profile for tin-lead eutectic solder

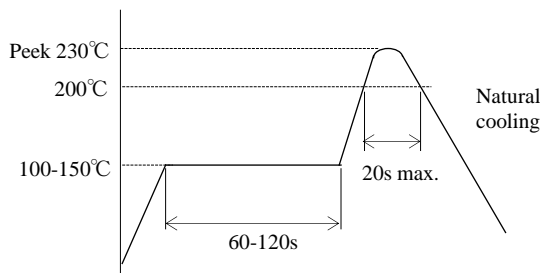
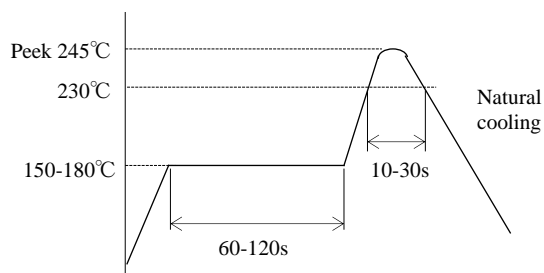

8-3.Iron soldering

Use a solder iron of less than 30W. When soldering, do not allow the solder iron tip directly touch the ferrite body out side of the terminal electrode. 3s max. at 380°C.

9.Packaging

The packaging must be done not to receive any damage transporting and storing. The following matters are mentioned on bar code label.

- 1)Your product part number
- 2)Our product part number
- 3)Shipment number\*
- 4)Quantity
- 5)Shipment day

\*shipment number[e.g.]      ○○    ○○    ○    ○○○○○○    ○○  
 (1)Our control number      (1)    (2)    (3)    (4)    (5)  
 (2)Last digit of A.D  
 (3)Shipment month (A~H:Jan.~Aug., J~M:Sep.~Dec.)  
 (4)Sequence number  
 (5)Control mark

10.Attentin in case of using

- 1)In case of using this product, please avoid following matters.
  - Splashing water of salt water
  - Dew condenses
  - Toxic gas (Hydrogen sulfide, Sulfurous acid, Chlorine, Ammonia, etc.)
  - Vibrations or shocks which exceed the specified condition
- 2)Please be careful for the stress to this product by board flexure or something after the mounting.
- 3)This product is only for reflow soldering.(is not available for flow soldering).
- 4)This product should not be washing in a solvent.
- 5)Since a function may deteriorate when you use a coating material etc., please carry out sufficient evaluation in advance.
- 6)Please do enough mounting test in case of using.
- 7)If acoustic noise was occurred by magnetostrictive, it is preferable that reject or attenuate the audible frequency of current.

11. Packaging form

11-1. Tape dimension

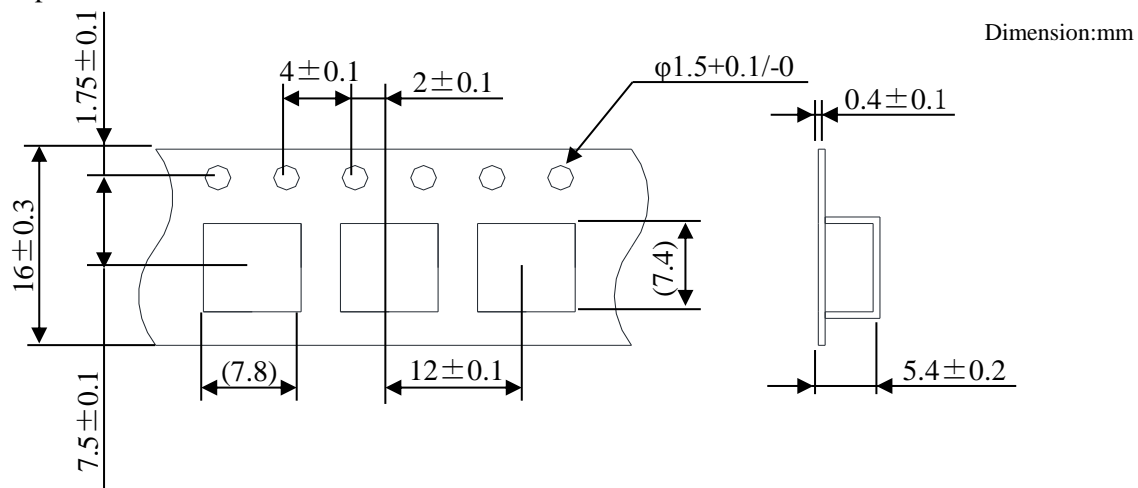

11-2. Reel dimension

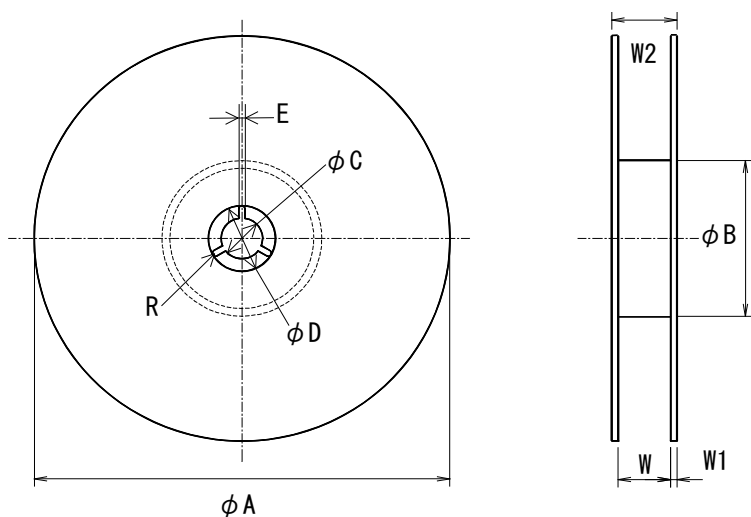

φA	φB	φC	φD	E	W	W1	W2	R
φ330±2	φ100±1	φ13.0±0.5	φ21.0±0.8	2.0±0.5	16.4+2.0/-0	(2.0)	22.4max	(1.0)

11-3. Taping figure

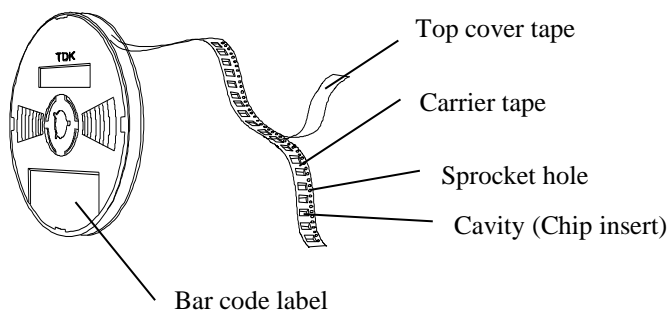



11-4. Taping dimensions

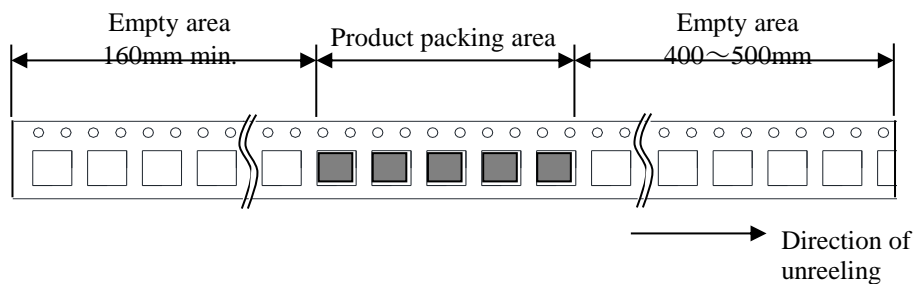

11-5. Polar direction

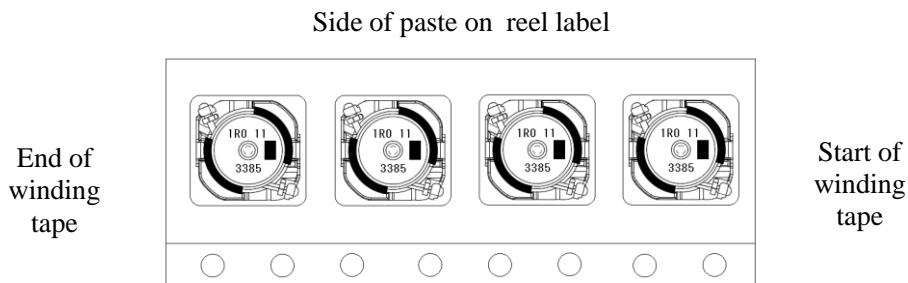

11-6. Taping quantity

1000pcs/reel

11-7. Cover tape peel strength

The force for tearing off cover tape is 0.1~1.3(N) in the arrow direction at the following conditions.

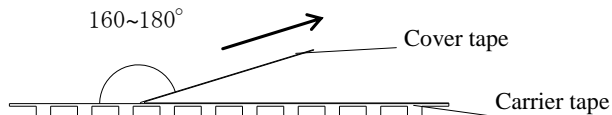

12. Dimensions of carton

