

承認書

SPECIFICATION

客戶：
(Customer) 立創

品名：
(Product Name) 鋁電解電容器

規格：
(Specifications) VZL 25V3300UF D18*16.5MM

日期：
(Date) 2021年11月17日

供應商簽署欄Supplier confirmation		
PREPARED BY	CHECKED BY	APPROVED BY
 <p>技术中心 骆英芳</p>	 <p>技术中心 刘平</p>	 <p>技术中心 吉泽锋</p>

客戶確認簽署欄Customer confirmation

VZL 电容规格承认书目录

Leaguer product specification content

1、 Standard Rating 基本参数.....	P.2
2、 Scope 概述.....	P.3
3、 Applicable Specifications 参考标准.....	P.3
4、 Operating Temperature Range 工作温度范围.....	P.3
5、 Condition of Test 测试环境.....	P.3
6、 Electrical Requirements 电性能要求.....	P.4~7
7、 Marking 标示.....	P.8
8、 Part No System 物料编码.....	P.9
9、 Taping shapes & Dimensions 编带尺寸.....	P.10
10、 Details of Carrier Tape 编带补充说明.....	P.11
11、 Adhesion Test 编带粘接力测试.....	P.12
12、 Dimensions of Outer Carton Box 外包装箱尺寸.....	P.12
13、 Packing Quantity 包装数量.....	P.12
14、 Fixing 安装.....	P.13
15、 Other Remarks 其它说明.....	P.14~15

1、 Standard Rating 基本参数

单位 Unit : mm

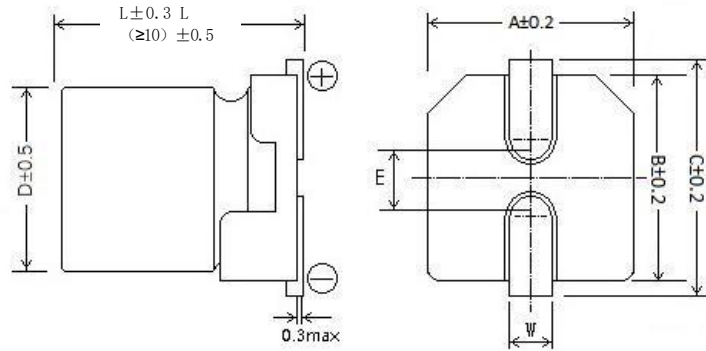

No.	Customer Part No.	LEAGUER Part No.	Capacitance (uF)	Tolerance on Rated Capacitance (%)	Rated Voltage (Vdc)	Surge Voltage (Vdc)	Operating Temp. Range (°C)	tanδ (120Hz) (Max)	Leakage Current (uA)(2min.)	Max Ripple Current (mA) at 105°C 100kHz	Impedance (Ω) Max at 20°C, 100kHz	Endurance at 105°C (Hours)	Dimensions (mm)						
													φD	L	A	B	C	E	W
1		VZL1E332M1816V1	3300	±20	25	28.8	-55~+105	0.18	825	2060	0.033	5000	18	16.5	19.0	19.0	20	6.5	1.1~1.4

2、 SCOPE 概述

本承认书规定了 VZL 系列纵型贴片型铝电解电容器的技术规范，本技术规范条文解释权归本公司所有。

This specification covers "VZL series" longitudinal SMD aluminum electrolytic capacitor , Leaguer reserves the right of final interpretation for this technical specification.

3、 APPLICABLE SPECIFICATION 参考标准

本承认书参考 JIS-C-5101-1 和 JIS-C-5101-4 制定。

This approval sheet consulted the institute of JIS-C-5101-1 and JIS-C-5101-4.

4、 OPERATING TEMPERATURE RANGE 工作温度范围

工作温度范围是电容器在施加额定工作电压条件下，可以长期可靠工作的环境温度范围。

-55℃~+105℃（6.3V.DC~100V.DC）

Operating temperature range is the range of ambient temperature at which the capacitor can be operated continuously at rated voltage.

-55℃~+105℃（6.3V.DC~100V.DC）

5、 CONDITION OF TEST 测试环境

如果没有其他规定，标准的测试、检验环境条件如下所示：

环境温度：15℃~35℃

相对湿度：45%~75%

大气压力：86kpa~106kpa

如果对测试结果有异议，可以在以下条件测试：

环境温度：20±1℃

相对湿度：60%~67%

大气压力：86kpa~106kpa

Unless otherwise specified, the standard range of atmospheric conditions for making measurements and tests are as follows

Ambient temperature : 15℃ to 35℃

Relative humidity : 45% to 75%

Air pressure : 86kpa to 106kpa

If there may be doubt on the results, measurements shall be made within the following limits

Ambient temperature : 20±1℃

Relative humidity : 60% to 67%

Air pressure : 86kpa to 106kpa

6、 Electrical Requirements 电性能要求

Name	VZL	Version	01	Page	3
------	-----	---------	----	------	---

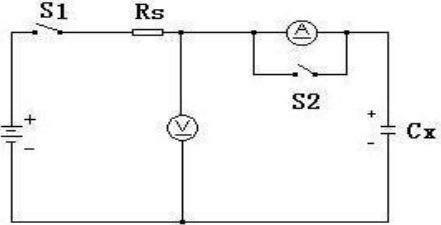
序号 No.	项目 Item	测试方法 Test method	性能 Performance																														
6.1	额定工作电压 Rated voltage		6.3V.DC~100V.DC																														
6.2	电容量 Capacitance	测试频率: 120Hz(±20%) 测试电路: 串联等效 测试电压: 0.5Vrms 以下 Measuring frequency: 120Hz ± 20% Measuring circuit : Series equivalent circuit Measuring voltage : 0.5Vrms	容量范围: 10 μ F ~2200 μ F 容量偏差: -20%~+20% Range of Capacitance: 10 μ F ~2200 μ F Capacitance tolerance: -20%~+20%																														
6.3	损失角正切值 Dissipation factor	测试条件与 6.2 电容量测试相同 Testing conditions are the same as 6.2 for capacitance																															
		W.V	6.3	10	16	25	35	50	63	80	100																						
		Tg δ	0.28	0.24	0.20	0.16	0.13	0.10	0.08	0.08	0.08																						
6.4	漏电流 Leakage current	<p>在电容器两端施加额定工作电压，并串联 1000 ± 100 Ω 电阻，在施加规定时间电压后，测量漏电流。</p> <p>测试电路如下图:</p> <p>The rated voltage shall be applied across the capacitor and its protective resistor shall be 1000 ± 100 Ω . The leakage current shall then be measured after an electrification period of schedule time.</p> <p>Measurement circuit</p>  <p>Rs: Protective resistor(1000 ± 100 Ω) DC ammeter DC voltmeter S1: Switch S2: Protective switch for an ammeter</p>	<p>6.3V~100V: I ≤ 0.01CV 或 3 μ A, 取较大值 (2 分钟后)</p> <p>6.3V~100V: I ≤ 0.01CV or 3 μ A Whichever is greater (after 2 min)</p> <p>I: 漏电流 (μ A) C: 容量 (μ F) V: 额定工作电压 (V) I: Leakage current(μ A) C: Capacitance(μ F) V: Rated voltage (V)</p>																														
6.5	低温特性 Low Temperature Characteristics (at 120Hz)	<table border="1"> <thead> <tr> <th>WV</th> <th>6.3</th> <th>10</th> <th>16</th> <th>25</th> <th>35</th> <th>50</th> <th>63</th> <th>80</th> <th>100</th> </tr> </thead> <tbody> <tr> <td>Z_{-25℃}/ Z_{+20℃}</td> <td>2</td> <td>2</td> <td>2</td> <td>2</td> <td>2</td> <td>2</td> <td>2</td> <td>2</td> <td>2</td> </tr> <tr> <td>Z_{-40℃}/ Z_{+20℃}</td> <td>3</td> <td>3</td> <td>3</td> <td>3</td> <td>3</td> <td>3</td> <td>3</td> <td>3</td> <td>3</td> </tr> </tbody> </table>	WV	6.3	10	16	25	35	50	63	80	100	Z _{-25℃} / Z _{+20℃}	2	2	2	2	2	2	2	2	2	Z _{-40℃} / Z _{+20℃}	3	3	3	3	3	3	3	3	3	
WV	6.3	10	16	25	35	50	63	80	100																								
Z _{-25℃} / Z _{+20℃}	2	2	2	2	2	2	2	2	2																								
Z _{-40℃} / Z _{+20℃}	3	3	3	3	3	3	3	3	3																								
序号 No.	项目 Item	测试方法 Test method	性能 Performance																														

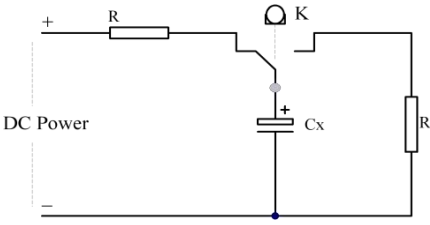
6.6	Characteristics at High and Low Temperature 高低温特性	<table border="1"> <thead> <tr> <th>Step</th> <th>Test Temperature</th> <th>Time</th> </tr> </thead> <tbody> <tr> <td>1</td> <td>20±2°C</td> <td>-</td> </tr> <tr> <td>2</td> <td>-40±3°C</td> <td>2 hours</td> </tr> <tr> <td>3</td> <td>20±2°C</td> <td>15min</td> </tr> <tr> <td>4</td> <td>105±2°C</td> <td>2 hours</td> </tr> </tbody> </table>	Step	Test Temperature	Time	1	20±2°C	-	2	-40±3°C	2 hours	3	20±2°C	15min	4	105±2°C	2 hours	阶段 2 阻抗比: 相对于阶段 1 比值小于 6.5 中的值 Step2 Impedance ratio: relative to Step2, the ratio is less than the value in 6.5 阶段 4 漏电流: 小于或等于规定值的 8 倍 Step4 Leakage Current : Less than 800% of the specified value
		Step	Test Temperature	Time														
1	20±2°C	-																
2	-40±3°C	2 hours																
3	20±2°C	15min																
4	105±2°C	2 hours																
阶段 1: 测量容量和阻抗 (z 20°C 120Hz±20%) 阶段 2: 电容器恒温贮存 2 小时, 在热平衡状态测阻抗 (z -40°C 120Hz±20%) 阶段 4: 电容器恒温贮存 2 小时, 在热平衡状态测漏电流 Step 1:Capacitance and impedance shall be measured. (z 20°C 120Hz±20%) Step 2:After the capacitor being stored for 2 hours, impedance shall be measured at thermal stability. (z -40°C 120Hz±20%) Step 4:After the capacitor being stored for 105°C 2 hours,leakage current shall be measured. The measurement shall be made at thermal stability																		
6.7	耐浪涌电压 Surge Test	对电容器施加浪涌电压, 每充电 30s, 放电 5min30sec, 连续循环 1000 次后测量。 测试温度: 15~35°C。 After surge voltage(the value of page 2) applied at a cycling rate of 30 seconds charge and 5.5 minutes discharge 1000 successive test cycle. Test temperature:15~35°C.	漏电流: ≤第 2 页规定值 Leakage Current : Less than the specified value of page 2 容量变化: 与初始测量值比变化率 ±15%范围内 Capacitance Change : Within ±15% of the initial measured value 损耗角正切值: 规定值的 150%。 Tangent of Loss Angle : Less than 150% of specified value															
		Test circuit  <p>Note: This requirement is applicable only to instantaneous over voltage which may be applied to terminals of capacitor, therefore, not applicable to such over voltages as often applied.</p>																

序号 No.	项目 Item	测试方法 Test method	性能 Performance
-----------	------------	---------------------	-------------------

6.8	可焊性 Solderability	温度: 235±2℃ 浸入时间: 3±0.5sec 浸入深度: 浸入引线约 0.5~1mm 助焊剂: 约 25%的松香溶于酒精 Temperature : 235±2℃ Immersing Time: 3±0.5sec Immersing Depth : Dip the terminal for Approx. 0.5~1mm thick Flux: Approx. 25% rosin in Ethanol	引线端子表面 95%以上的面积附着新焊料。 More than 95% of the terminal surface shall be covered with new solder.
6.9	振动 Vibration	频率: 10 到 55 Hz, 每分钟互换 振幅: 0.75mm 在互相垂直的3个方向上, 每个方向振动2小时, 共 6 小时。 Frequency: 10~55Hz reciprocation for 1 min Total amplitudes: 0.75mm Direction and during of vibration: 3 orthogonal directions, Mutually each for 2hrs total 6hrs	外观: 无可见损伤 容量变化: 容量变化率在±10%范围内 Appearance: No significant change can be observe Capacitance change : Within ±10% of initial measured value
6.10	耐焊接热 Solder Heat-Resistance Test	将电容器通过回流焊后, 在室温恢复 1~2 小时。 After reflow soldering the capacitor shall be restored to 20℃ within two hours or over an hour.	外观: 无可见损伤 容量变化: 容量变化率在±10%范围内 Appearance: No significant change can be observe Capacitance change : Within ±10% of initial measured value
6.11	标示耐溶剂性 Solvent Resistance of the Marking	试剂: 纯水 温度: 55℃ 浸入时间: 5 分钟 Class of Reagent:Water Test Temperature: 55℃ Immersing Time: 5 minutes	标示应清晰可辨 There shall be no damage end legibly marked. Marking can be deciphered easily.
6.12	稳态湿热 Resistance to damp heat (steady state)	电容器放置在温度 60℃、湿度 90~95%的环境下 500±6 小时, 然后放置在标准环境中恢复 1-2 小时 Capacitors shall be exposed for 500±6hrs in an atmosphere of 90~95% R.H. at 60℃. And then the capacitor shall be subjected to standard atmospheric conditions for 1-2 hours, after which measurements shall be made.	容量变化: 与初始测量值比变化率在 ±20%范围内。 损耗角正切值: ≤规定值的 1.5 倍 漏电流: ≤规定值 外观: 无可见损伤 Capacitance Change: Within ±20% of the initial measured value Tangent of Loss Angle : Less than 150% of the specified value Leakage Current : Less than the specified value Appearance : No significant change can be observed.

序号 No.	项目 Item	测试方法 Test method	性能 Performance
-----------	------------	---------------------	-------------------

6.13	<p>高温负荷寿命 High Temperature Unload Life Test</p>	<p>温度: 105±2℃ 试验持续时间: 5000 小时。 施加电压: 额定电压 试验完成后, 电容器在测量前应在室温中恢复 16 小时。 Test Duration: 5000hours。 Applied Voltage: RatedVoltage After subjected to the test, the capacitors shall be left at the room temperature for 16 hours prior to the measurement.</p>	<p>容量变化:与初始测量值比变化率在 ±30%范围内。 损耗角正切值 :≤规定值的 3 倍 漏电流 :≤规定值 外观:无可见损伤 Capacitance Change: Within ±30% of the initial measured value Tangent of Loss Angle : Less than 300% of the specified value Leakage Current : Less than the specified value Appearance: No significant change can be observed.</p>
6.14	<p>高温储存 High Temperature Unload Life Test</p>	<p>温度: 105±2℃ 试验持续时间: 1000 小时 试验完成后, 电容器在测量前应在室温中恢复 16 小时。 Test Temperature: 105±2℃ Test Duration: 1000 hours After subjected to the test, the capacitors shall be left at the room temperature for 16 hours prior to the measurement.</p>	<p>容量变化:与初始测量值比变化率在 ±20%范围内。 损耗角正切值 :≤规定值的 2 倍 漏电流 :≤规定值的 2 倍 外观:无可见损伤 Capacitance Change: Within ±20% of the initial measured value Tangent of Loss Angle : Less than 200% of the specified value Leakage Current : Less than 200% of the specified value Appearance: No significant change can be observed.</p>

■ 额定纹波电流频率系数 Coefficient of Frequency for Rated Ripple Current

Frequency Capacitance	120Hz	1KHz	10KHz	100KHz
1.0~180μF	0.40	0.75	0.90	1.00
220~560μF	0.50	0.85	0.94	1.00
680μF~	0.60	0.87	0.95	1.00

7、Marking 标示

a) Following items shall be marked on the body of capacitor. The marking color is black. 电容器的本体上印刷以下内容，颜色为黑色。

- | | | | |
|------|-------------------|------------|------------------------------|
| i. | Rated Voltage | 额定电压 | |
| ii. | Capacitance | 额定容量 | |
| iii. | Negative Polarity | 负极标示 | ($\phi 6.3 \sim \phi 10$) |
| iv. | Series | (VZL) 系列代码 | |
| v. | Cycle code | 周期代码 | ($\phi 12.5 \sim \phi 18$) |

b) Marking content as below.

电容器标签印刷以下内容。

- | | | |
|-------|------------------------------------|--------------|
| i. | Series | 系列代码 |
| ii. | Capacitance tolerance | 电容量误差 |
| iii. | Lot Number | 制造批号 |
| iv. | Customer's Part Number(if request) | 客户料号（客户有要求时） |
| v. | Date | 日期 |
| vi. | Rated Voltage and Capacitance | 额定电压&容量 |
| vii. | Packing quantity | 编带数量 |
| viii. | Size | 尺寸 |

8、PART NO SYSTEM 物料编码

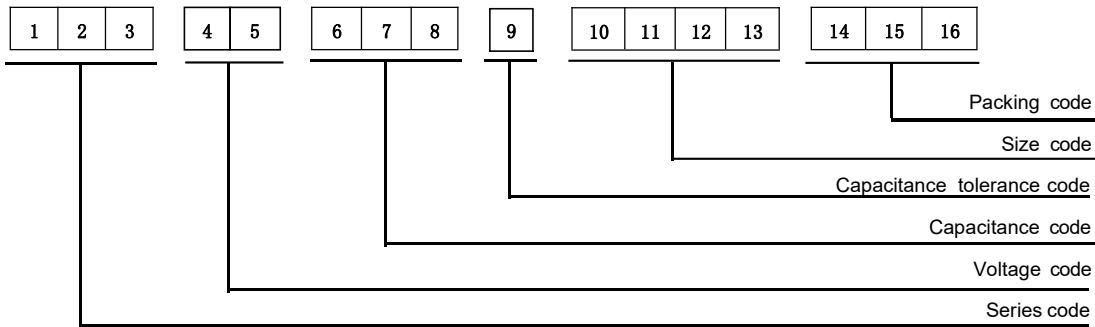

1 2 3	4 5	6 7 8	9	10 11 12 13	14 15 16					
Series code	Voltage (V)	Code	Capacitance (μF)	Code	Capacitance tolerance	Code	Size	Code	Packing	Code
VZL	2.5	0E	0.1	0R1	±5%	J	4×5.4	0405	Paper reel	V1
VT1	4	0G	0.22	R22	±10%	K	5×5.4	0505		
VTD	6.3	0J	0.33	R33	±15%	Y	6.3×5.4	0605	Plastic reel	V2
VLD	10	1A	0.47	R47	±20%	M	6.3×7.7	0607		
VZ2	16	1C	0.68	R68	-10~-30%	Q	8×6.2	0806	Vacuum packaging	V3
VZS	25	1E	1.0	010	Others	T	8×8	0808		
VTG	35	1V	2.2	2R2			8×10.2	0810	Automotive Grade	V1C
VLG	50	1H	3.3	3R3			10×10.2	1010		
VKG	63	1J	4.7	4R7			10×12.5	1012	Anti-vibration	V1G
VTK	80	1K	6.8	6R8			12.5×13.5	1213		
VKZ	100	2A	10	100			12.5×16	1216	Automotive Grade	V2C
VTL	160	2C	22	220			16×16.5	1616		
VLL	180	2J	33	330			16×21.5	1621	Anti-vibration	V2G
	200	2D	47	470			18×16.5	1816		
	220	2P	68	680			18×21.5	1821		
	250	2E	100	101						
	315	2F	220	221						
	330	2U	330	331						
	350	2V	470	471						
	400	2G	680	681						
	420	2M	1000	102						
	450	2W	2200	222						
500	2H	3300	332							
550	2J	4700	472							
600	2K	6800	682							
			10000	103						
			22000	223						
			33000	333						
			68000	683						

9、Taping shapes & Dimensions 编带尺寸 (单位: mm)

● Carrier tape 编带

$\phi D \times L$	$W \pm 0.3$	$A \pm 0.2$	$B \pm 0.2$	$F \pm 0.1$	$P_1 \pm 0.1$	$t_2 \pm 0.2$
$\phi 4 \times 5.4$	12.0	4.7	4.7	5.5	8.0	5.8
$\phi 5 \times 5.4$	12.0	6.0	6.0	5.5	12.0	5.8
$\phi 6.3 \times 5.4$	16.0	7.0	7.0	7.5	12.0	5.8
$\phi 6.3 \times 7.7$	16.0	7.0	7.0	7.5	12.0	8.0
$\phi 8 \times 6.2$	16.0	8.7	8.7	7.5	12.0	6.8
$\phi 8 \times 10.2$	24.0	8.7	8.7	11.5	16.0	11.0
$\phi 10 \times 10.2$	24.0	10.7	10.7	11.5	16.0	11.0
$\phi 10 \times 12.5$	24.0	10.7	10.7	11.5	16.0	13.0
$\phi 12.5 \times 13.5$	32.0	13.4	13.4	14.2	24	14.5
$\phi 12.5 \times 16$	32.0	13.4	13.4	14.2	24	17.0
$\phi 16 \times 16.5$	44.0	17.5	17.5	20.2	28	17.0
$\phi 16 \times 21.5$	44.0	17.5	17.5	20.2	28	22.4
$\phi 18 \times 16.5$	44.0	19.5	19.5	20.2	32	17.0
$\phi 18 \times 21.5$	44.0	19.5	19.5	20.2	32	22.4

● Reel 编带包装盘

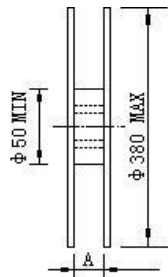
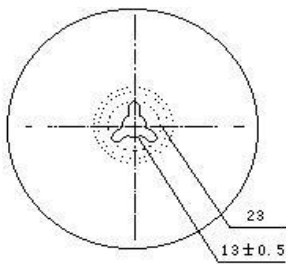

ϕD	4	5	6.3	8	10	12.5	16	18
A	14	14	18	26	26	34	46	46

10、Details of Carrier Tape 编带补充说明

Name	VZL	Version	01	Page	10
------	-----	---------	----	------	----

(1) 收料卷动开始时 Reeling begin:

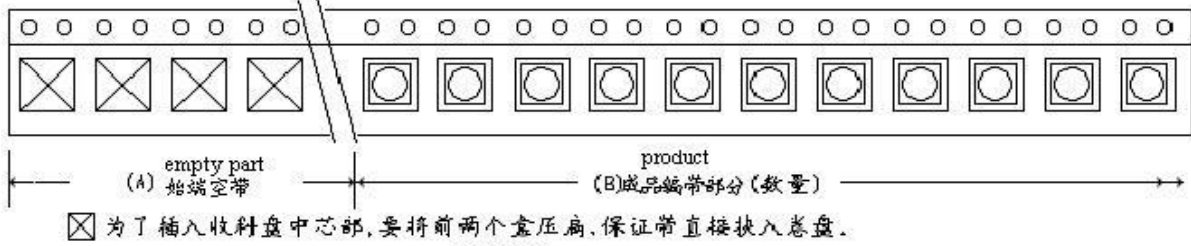

(2) 收料卷动结束时 Reeling over:

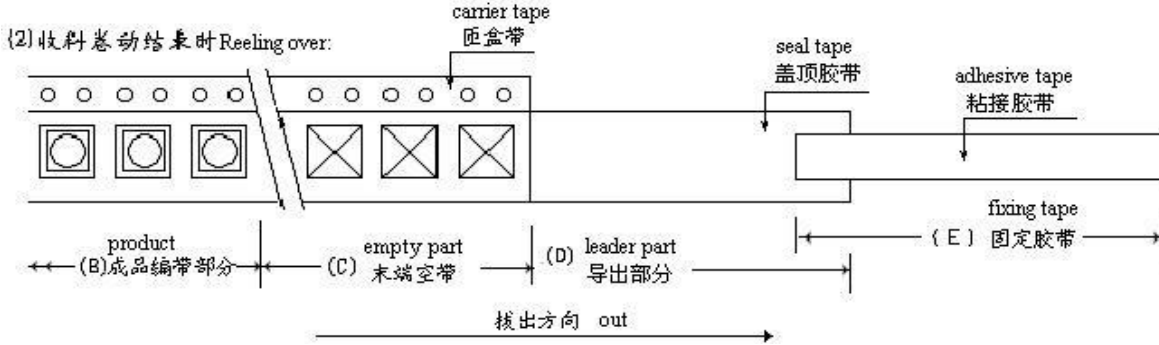

Last reeling empty part of carrier tape shall be more than 10cm.

每盘编带产品的末端空带不少于 10cm。

Leader part of seal tape shall be more than 20cm.

结尾处盖顶胶带的导出部分不少于 20cm。

Adhesive tape fixing the end of the leader part shall be approx. 10cm.

粘接盖顶胶带的固定胶带长约 10cm。

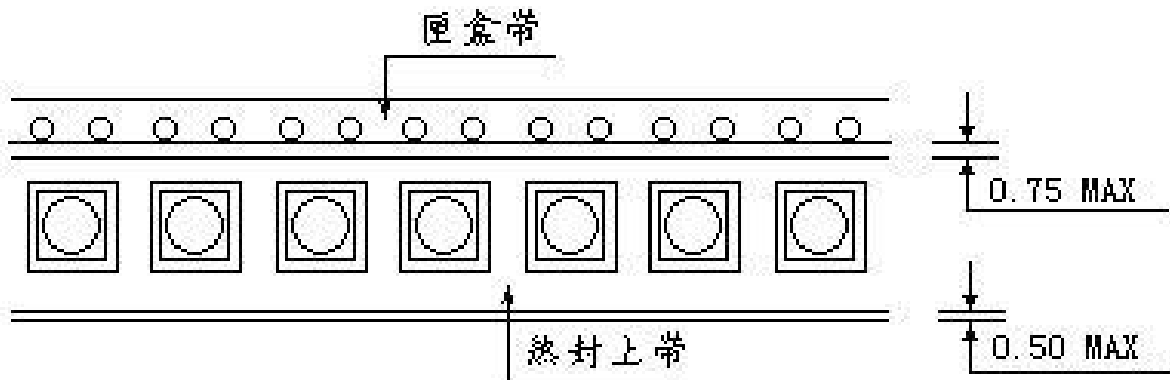

Deviation between carrier tape and seal tape shall be less than 0.5mm

盖顶胶带的偏移不超过 0.5mm.

Seal tape shall not cover on the feeling hoers .

盖顶胶带不可覆盖导带孔的部分.

11、Adhesion Test 编带粘接力测试

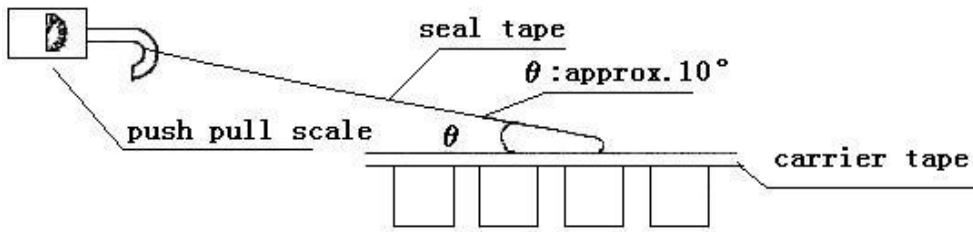

Reasonable pulling strength: 0.092~0.882N; Pulling speed: 200~300mm/min.
 适当的粘接力强度: 0.092~0.882N; 测试速度: 200~300mm/min。

12、Dimensions of Outer Carton Box 外包装箱尺寸

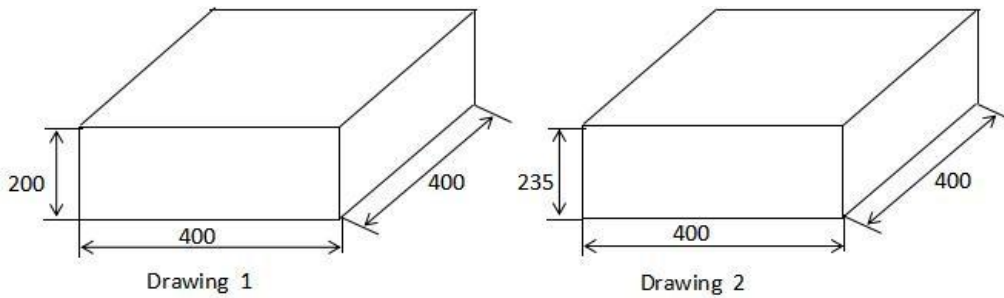

13、Packing Quantity 包装数量

Size	Quantity/one reel (pcs)	Quantity/one box (pcs)	Outer box size
φ 4×5.4	2000	20000	Drawing 1
φ 5×5.4	1000	10000	Drawing 1
φ 6.3×5.4	1000	10000	Drawing 2
φ 6.3×7.7	1000	10000	Drawing 2
φ 8×10.2	500	3000	Drawing 1
φ 10×10.2	500	3000	Drawing 1
φ 10×12.5	400	2400	Drawing 1
φ 12.5×13.5	250	1250	Drawing 1
φ 12.5×16	200	1000	Drawing 1
φ 16×16.5	200	800	Drawing 2
φ 16×21.5	125	500	Drawing 2
φ 18×16.5	150	600	Drawing 2
φ 18×21.5	125	500	Drawing 2

14、Fixing 安装

Recommend land size 建议安装尺寸

Name		Page	12
------	--	------	----

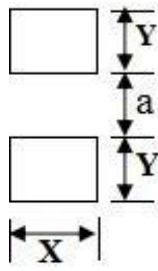

尺寸 side	X	Y	a
Φ4	1.6	2.6	1.0
Φ5	1.6	3.0	1.4
Φ6.3	1.6	3.5	2.1
Φ8	2.2	3.9	3.0
Φ10	2.5	4.5	4.0
Φ12	3.0	5.5	5.0
Φ16	3.0	6.5	7.0
Φ18	3.0	7.5	7.0

■ 回流焊温度与时间曲线 Temperature/ Time profile

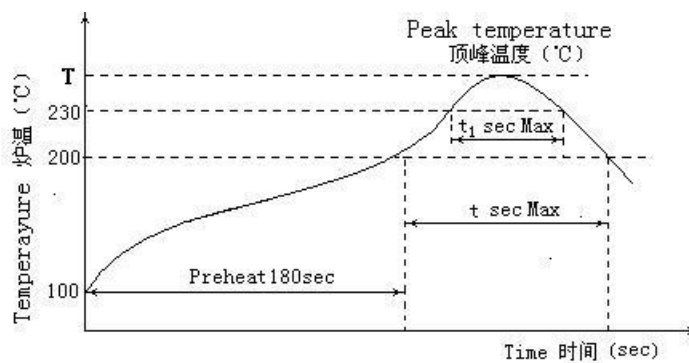

■ 不同壳号的焊接温度及时间 Allowable Range of Peak Temperature

Size	T(°C)	t (second)	t ₁ (second)
Φ4~Φ6.3	255	100	50
Φ8~10	245	100	40
Φ12.5~18	245	100	40

- Preheat shall be done at 100°C~200°C and for maximum 180 seconds.
100~200°C的预热时间不超过 180 秒。
- If capacitors are subject to the conditions other than the allowable range of reflow , please contact to us.

如果电容器承受的条件与回流焊的允许范围不同，请与我们联系。

15、OTHER REMARKS 其它说明

15.1 铝电解电容器使用注意事项 IMPORTANT INFORMATION ON THE APPLICATION OF ALUMINUM ELECTROLYTIC CAPACITORS

- (1)直流铝电解电容器应按正确的极性使用 DC aluminum electrolytic capacitors are normally polarized
当直流铝电解电容器按反极性接入电路时，电容器会导致电子线路短路，由此产生的电流会引致电容器

损坏。若电路中有可能在负引线施加正电压，请选无极性产品。

When reverse voltage is applied on DC aluminum electrolytic capacitor ,the circuit will be short out and the capacitor will be damaged due to abnormal current flows through the capacitor. Please use non- polar types of capacitors when the positive voltage is applied on the cathode terminal.

(2) 在额定工作电压以下使用 Use capacitor within rated voltage

当电容器上所施加电压高于额定工作电压时，电容器的漏电流将上升，其电气特性将在短时期内劣化直至损坏。请注意电压峰值勿超出额定工作电压。

When capacitor is used at higher voltage than the rated voltage, leakage current may increase and characteristics may be drastically deteriorated and damaged in a short period. Please take extra caution that the peak voltage should not exceed the rated voltage.

(3) 作快速充放电使用 Sudden charge and discharge

当常规电容器被用作快速充电用途,其使用寿命可能会因为容量下降,温度急剧上升等而缩减。

When aluminum electrolytic capacitors for general purpose-use are employed in rapid charge and discharge application, its life expectancy may be shortened resulted from capacitance decrease, heat rise, etc.

(4) 电容器贮存 Storage of the capacitor

当铝电解电容器作了长期贮存后，其漏电流通常升高，贮存温度愈高，漏电流上升愈快。因此应注意贮存环境，在电容器上施加电压后，漏电流值将不断下降，如铝电解电容器的漏电流值上升对电路有不良影响，请在使用前充电处理。

Leakage current tends to increase when aluminum electrolytic capacitors have been stored for long period of time. The higher the storage temperature, the higher the leakage current increase. Please take caution when selecting the storage location. The leakage current will decrease gradually as voltage is applied to the capacitor. The capacitor is subjected to aging before using where increased leakage current may cause problems in the circuit.

(5) 施加纹波电流应小于额定值 Use capacitor within rated ripple current

施加纹波电流超过额定值后，会导致电容器体过热，容量下降，寿命缩短。所施加纹波电压的峰值应小于额定工作电压。

If excessive ripple current is applied on the capacitor, which will result in generating excessive heat inside, reducing capacitance and shortening life of capacitor. Therefore the peak value of the ripple voltage should be less than the rated value.

(6) 使用环境温度 Ambient temperature

铝电解电容器的使用寿命会受到环境温度的影响。据科学统计，使用环境温度下降 10℃其使用寿命增加 1 倍。

Life of aluminum electrolytic capacitor is affected by the ambient temperature. It is generally known that the life doubles for each 10℃ decrease in temperature.

(7) 引出线强度 Tensile strength of lead wire

当拉力施加到电容器引出线，该拉力将作用于电容器内部，这可能导致电容器内部短路，开路或漏电流上升。在电容器焊装到电路板，请勿强烈摇动电容器。

When a strong force is applied to the lead wires or terminals, stress is put on the internal connections, which may result in short circuit, open circuit or leakage current increase. Therefore it is not advisable to bend or handle a capacitor after it has been soldered to the PC board.

(8) 焊接过程耐热性 Heat resistance at the soldering process

铝电解电容器装至电路板进行浸焊或波峰焊时，其塑料套管可能因焊接时间过长、温度过高而发生破裂或二次收缩。

During soldering process, secondary shrinkage or sleeve crack may occur when soldering temperature is too high or soldering time is too long.

(9) 电路板的安装孔孔距及安装位置 Hole pitch and position of PC board

电路板安装孔的设计应与产品说明书的引线脚距相一致，如果将电容器强行插入孔距不配套的电路板，那么会有应力作用于引出线，这可能导致短路或漏电流上升。



When designing a PC board, its hole pitch should be designed to coincide with the lead pitch (lead spacing) of the capacitor specified in the catalog or specifications. When a capacitor is forcibly inserted into an unmatched hole pitch, a force will be put on the leads and which could result in a short circuit or increased leakage current.

(10) 关于焊接以后的清洗 Cleaning after soldering

① 电容器不能用卤化有机物系列的清洗剂进行清洗。如果必须进行清洗，请使用能够保证电容器质量的清洗剂。

The aluminum electrolytic capacitors should be free of halogenated solvents during board cleaning after soldering. Use solvent proof capacitors when halogenated solvents are used.

② 对于能够保证电容器质量的清洗剂，清洗后请不要在清洗溶液或者密封容器中保管。清洗后的电容器请和电路板一起在热风下干燥 10 分钟以上，热风的温度不可高于电容器规定上限温度。

After cleaned with the solvent which can guarantee the quality of capacitors, the capacitors should not be kept in solvent environments of non-ventilated places. Let the capacitors after cleaning dry with hot blast fully above 10mins and the temperature of hot blast should not be over than specified upper limit of that of capacitors.

(11) 关于固定剂以及镀层（涂层剂）Adhesives、fixative and coating materials(coating agent)

① 请不要使用含有卤化有机物系列的固定剂及镀层（涂层剂）。

Do not use halogenated adhesives and coating materials to fix aluminum electrolytic capacitors.

② 请不要让固定剂及镀层（涂层剂）将电容器封口部位（端子一侧）全部封住。

Do not cover up all the sealing area of capacitors with adhesives、fixative or coating materials (coating agent), make coverage only partial.

15.2 符合 RoHS RoHS compliance

符合欧盟 RoHS 的最新标准，若客户有特殊要求，按照双方签订的相关协议为准。

Completely in accordance with the latest standard of RoHS or relevant agreements reached by both parts if customer has special requirements.

