

NOTES:

- ELECTRICAL SPECIFICATIONS:
CURRENT RATING: 0.5A.
VOLTAGE RATING: 5V.
CONTACT RESISTANCE: 50 MILL.OHM MAX.
INSULATION RESISTANCE: 1000 MEG.OHM MIN.
- MECHANICAL SPECIFICATIONS:
DURABILITY: 5000 CYCLES MIN.

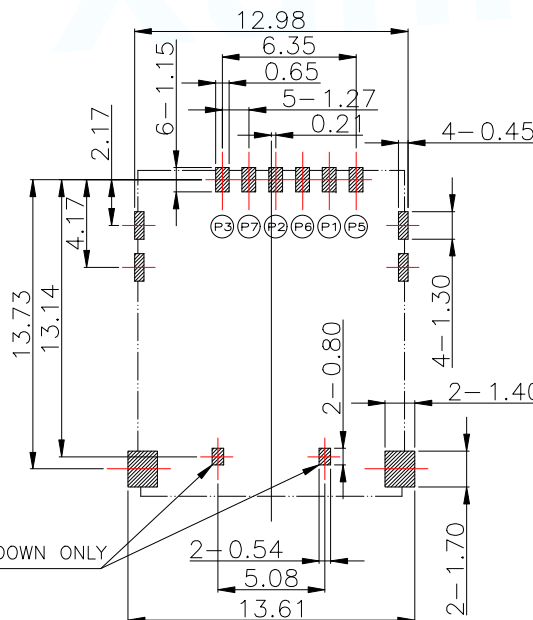
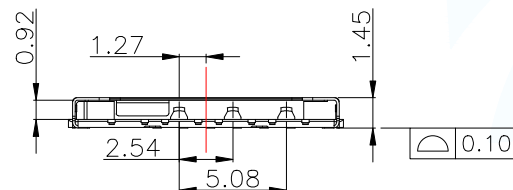

NOT GND
FOR HOLD-DOWN ONLY

RECOMMENDED PCB LAYOUT
GENERAL TOLERANCE ±0.05

MICRO SIM CARD	
Pin No.	NAME
P1	VCC OF SIM
P2	RST OF SIM
P3	CLK OF SIM
P5	GND OF SIM
P6	VPP OF SIM
P7	I/O OF SIM
P4/P8	N/A

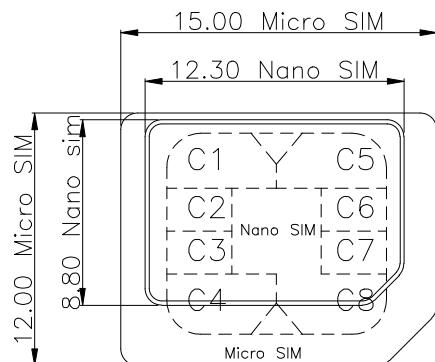

MANUFACTURE DWG		东莞市讯普电子科技有限公司 DongGuan XunPu Electronics Co.,Ltd	TITLE: MICRO SIM CARD CONNECTOR H1.45	
UNLESS OTHERWISE SPECIFIED TOLERANCES			PAR	SMC-204-ARP6
DECIMALS:	ANGLES:	DWN		
X.:±0.45	X'.:±5°	CHKD		
X.X:±0.35	X.X':±2°	APVD		
X.XX:±0.25		SCALE1:1	UNIT:MM	
CUSTOMER COPY		SIZE:A4	SHEET:1F1	
			REV:A	

<图一>

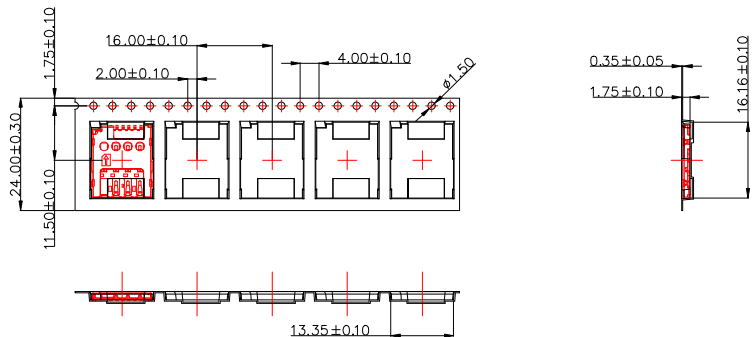

DETAIL A

放料方向

<图二>

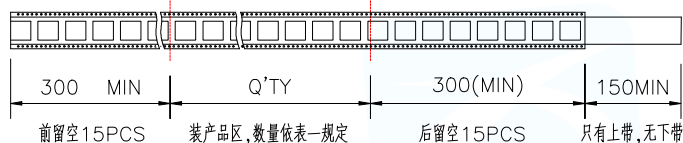

<表一>

包装数量		
PCS/卷	卷/箱	PCS/箱
1500	11	16500

<图三>

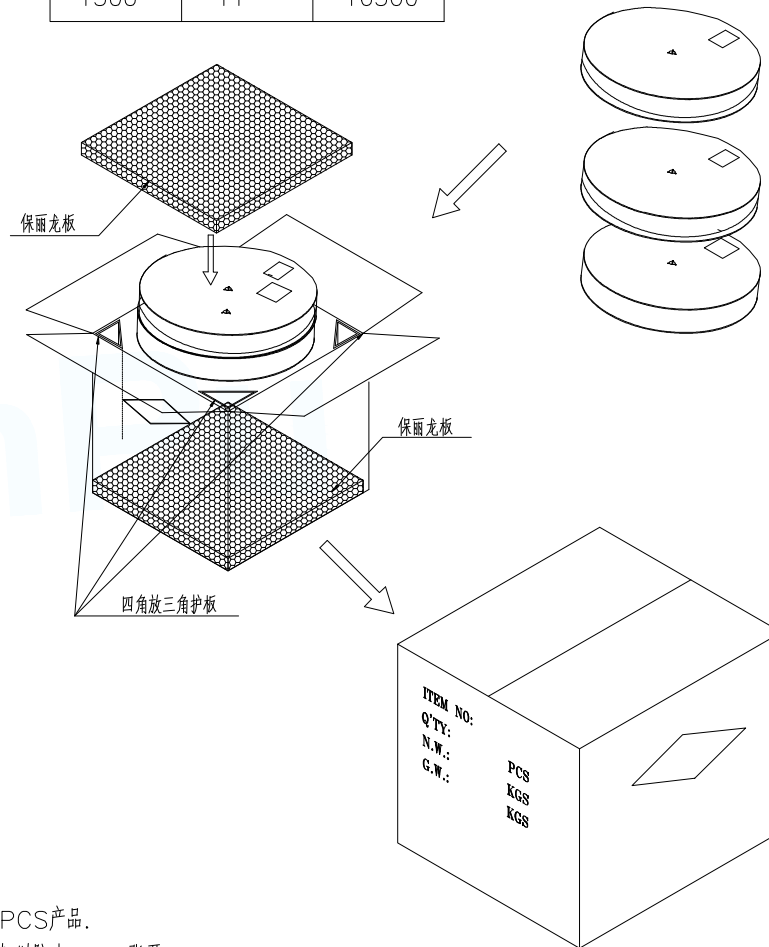

28.4 REF.

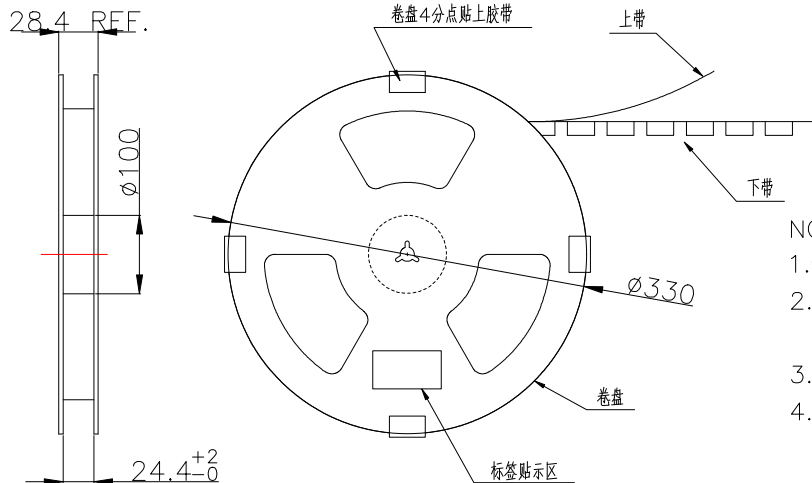

NOTE:

- 依<图一>示放置产品于下载中,每穴放置1PCS产品.
- 包装机包好后,在REEL的个等分点贴上胶带,以防止REEL张开,每REEL贴1PCS标签,如<图二>示
- 包装数量见如<表一>示
- 包装成箱见如<图三>示
箱底放保丽龙板,再依次将指定数量的卷装产品放入箱内,四角分别放入四个三角护板,最上层再放上保丽龙板.
- 封箱,在封好的纸箱上按客户要求写上料号,数量等
- 适用成品料号见如下<表二>

MANUFACTURE DWG		东莞市讯普电子科技有限公司 DongGuan XunPu Electronics Co.,Ltd	
UNLESS OTHERWISE SPECIFIED TOLERANCES			TITLE: MICRO SIM CARD CONNECTOR H1.45
DECIMALS:	ANGLES:		PAR SMC-204-ARP6
X.:±0.45	X'.':±5°		DWN
X.X:±0.35	X.X':±2°		CHKD APVD
X.XX:±0.25		CUSTOMER COPY	SCALE1:1 UNIT:MM
			SIZE:A4 SHEET:1F1 REV:A