

20 W + 20 W dual BTL class-D audio amplifier

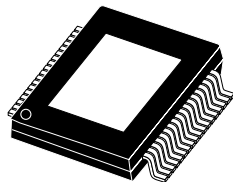

PowerSSO-36
exposed pad up

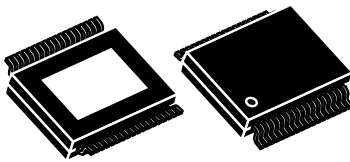

PowerSSO-36 with
exposed pad down

Features

- 20 W + 20 W continuous output power:
 - $R_L = 8 \Omega$, THD = 10% at $V_{CC} = 18 \text{ V}$
- Wide-range single-supply operation (5 - 18 V)
- High efficiency ($\eta = 90\%$)
- Four selectable, fixed gain settings of nominally 20 dB, 26 dB, 30 dB and 32 dB
- Differential input minimize common-mode noise
- No 'pop' at turn-on/off
- Standby and mute features
- Short-circuit protection
- Thermal overload protection
- External synchronisation

Description

The **TDA7491HV** is a dual BTL class-D audio amplifier with single power supply designed for LCD TVs and monitors.

Thanks to the high efficiency and exposed-pad-up (EPU) and down (EPD) packages, no separate heatsink is required.

The **TDA7491HV** is pin-to-pin compatible with the TDA7491P and TDA7491LP.

Product status link

[TDA7491HV](#)

Product summary

Order code	TDA7491HV13TR
Package	PowerSSO-36 EPD
Order code	TDA7491HVU13TR
Package	PowerSSO-36 EPU
Packing	Tape and reel
Temperature range	-40 to 85 °C

1 Device block diagram

Figure 1. Internal block diagram (showing one channel only) shows the block diagram of one of the two identical channels of the TDA7491HV.

Figure 1. Internal block diagram (showing one channel only)

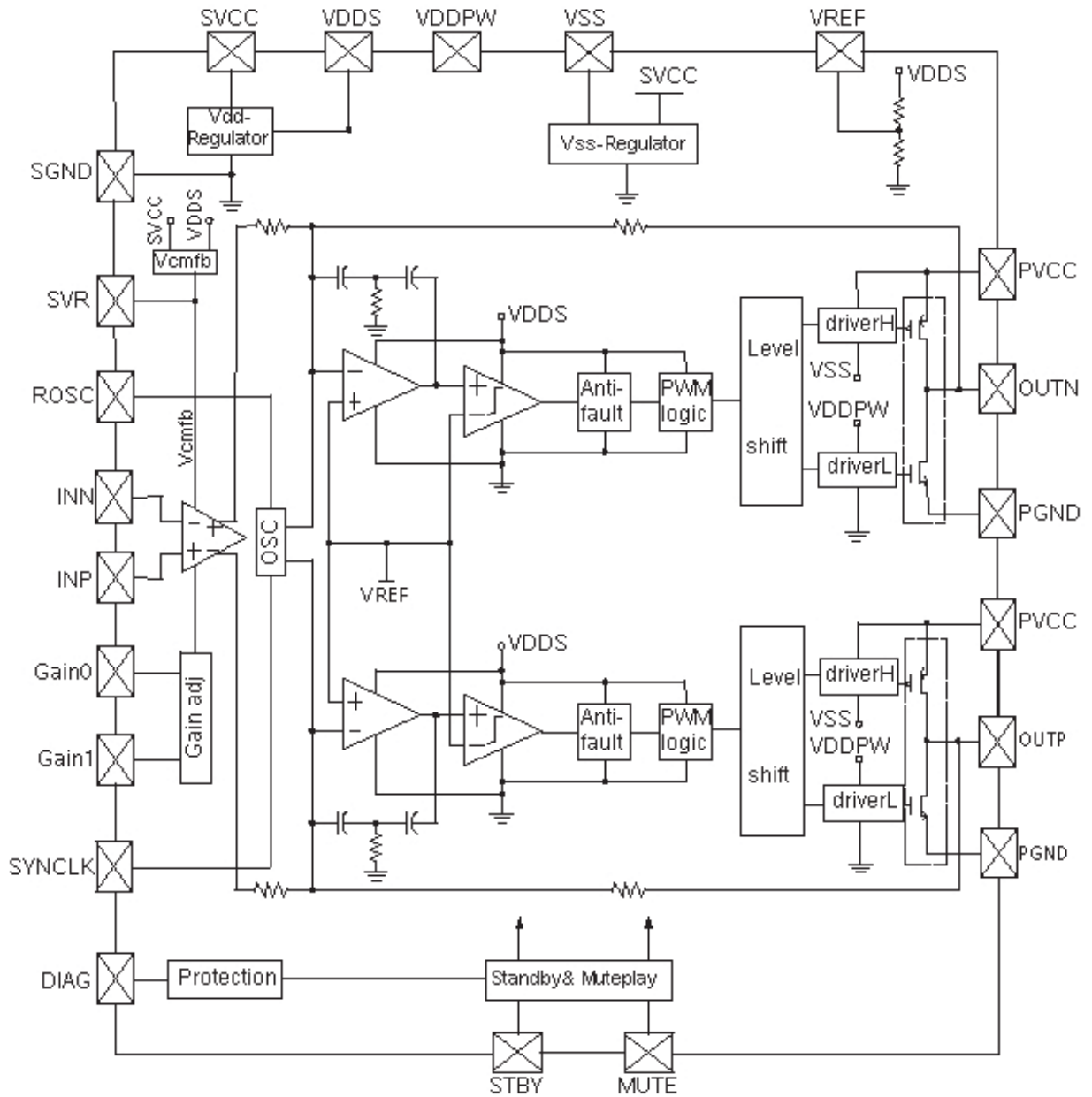

2 Pin description

2.1 Pinout (EPD)

Figure 2. Pin connections (top view)

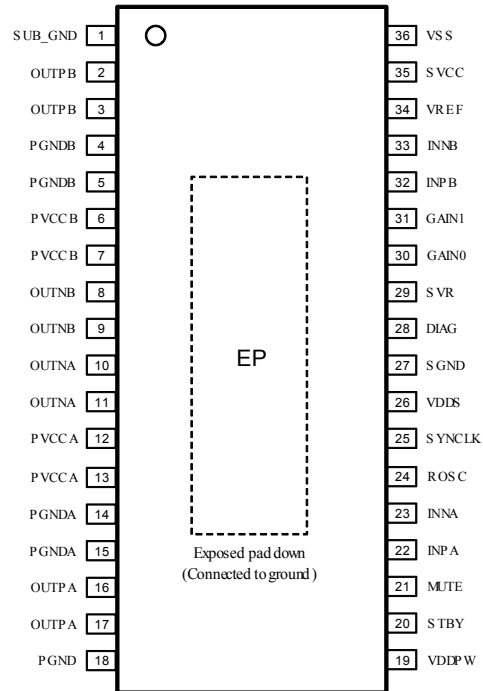

2.2 Pin list (EPD)

Table 1. Pin description list

Number	Name	Type	Description
1	SUB_GND	PWR	Connect to the frame
2,3	OUTPB	O	Positive PWM for right channel
4,5	PGNDB	PWR	Power stage ground for right channel
6,7	PVCCB	PWR	Power supply for right channel
8,9	OUTNB	O	Negative PWM output for right channel
10,11	OUTNA	O	Negative PWM output for left channel
12,13	PVCCA	PWR	Power supply for left channel
14,15	PGNDA	PWR	Power stage ground for left channel
16,17	OUTPA	O	Positive PWM output for left channel
18	PGND	PWR	Power stage ground
19	VDDPW	O	3.3-V (nominal) regulator output referred to ground for power stage
20	STBY	I	Standby mode control
21	MUTE	I	Mute mode control
22	INPA	I	Positive differential input of left channel
23	INNA	I	Negative differential input of left channel
24	ROSC	O	Master oscillator frequency-setting pin
25	SYNCLK	I/O	Clock in/out for external oscillator
26	VDDS	O	3.3-V (nominal) regulator output referred to ground for signal blocks
27	SGND	PWR	Signal ground
28	DIAG	O	Open-drain diagnostic output
29	SVR	O	Supply voltage rejection
30	GAIN0	I	Gain setting input 1
31	GAIN1	I	Gain setting input 2
32	INPB	I	Positive differential input of right channel
33	INNB	I	Negative differential input of right channel
34	VREF	O	Half VDDS (nominal) referred to ground
35	SVCC	PWR	Signal power supply
36	VSS	O	3.3-V (nominal) regulator output referred to power supply
-	EP	-	Exposed pad for heatsink, to be connected to GND

2.3 Pinout (EPU)

Figure 3. Pin connections (top view)

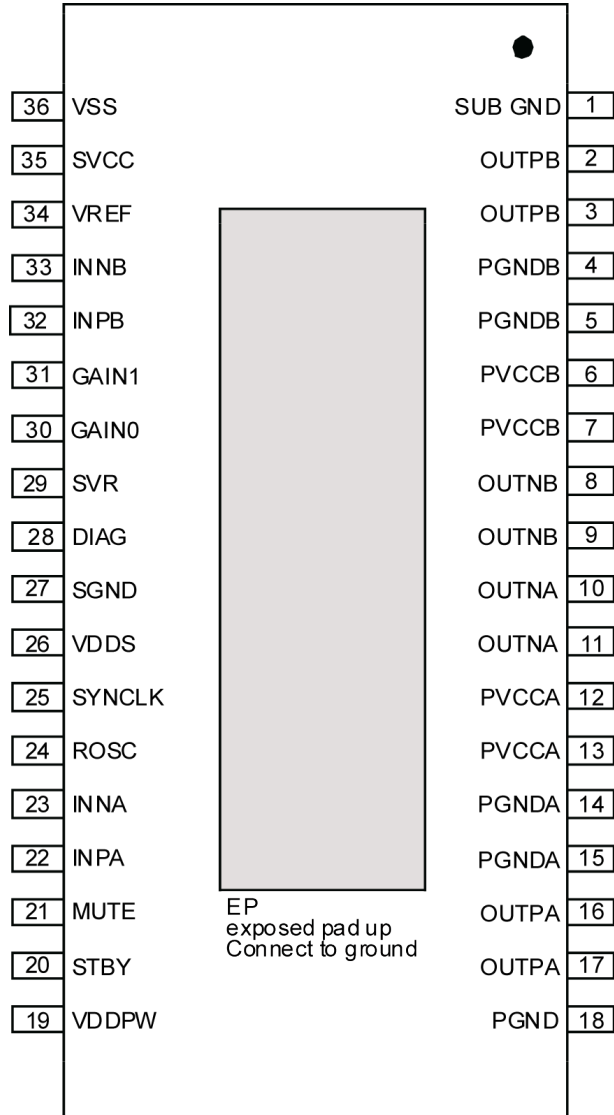

2.4 Pin list (EPU)

Table 2. Pin description list

Number	Name	Type	Description
1	SUB_GND	PWR	Connect to the frame
2, 3	OUTPB	O	Positive PWM for right channel
4, 5	PGNDB	PWR	Power stage ground for right channel
6, 7	PVCCB	PWR	Power supply for right channel
8, 9	OUTNB	O	Negative PWM output for right channel
10, 11	OUTNA	O	Negative PWM output for left channel
12, 13	PVCCA	PWR	Power supply for left channel
14, 15	PGNDA	PWR	Power stage ground for left channel
16, 17	OUTPA	O	Positive PWM output for left channel
18	PGND	PWR	Power stage ground
19	VDDPW	O	3.3 V (nominal) regulator output referred to ground for power stage
20	STBY	I	Standby mode control
21	MUTE	I	Mute mode control
22	INPA	I	Positive differential input of left channel
23	INNA	I	Negative differential input of left channel
24	ROSC	O	Master oscillator frequency-setting pin
25	SYNCLK	I/O	Clock in/out for external oscillator
26	VDDS	O	3.3 V (nominal) regulator output referred to ground for signal blocks
27	SGND	PWR	Signal ground
28	DIAG	O	Open-drain diagnostic output
29	SVR	O	Supply voltage rejection
30	GAIN0	I	Gain setting input 1
31	GAIN1	I	Gain setting input 2
32	INPB	I	Positive differential input of right channel
33	INNB	I	Negative differential input of right channel
34	VREF	O	Half VDDS (nominal) referred to ground
35	SVCC	PWR	Signal power supply
36	VSS	O	3.3 V (nominal) regulator output referred to power supply
-	EP	-	Exposed pad for heatsink, to be connected to GND

3 Absolute maximum ratings

Table 3. Absolute maximum ratings

Symbol	Parameter	Value	Unit
V _{CC}	DC supply voltage for pins PVCCA, PVCCB	23	V
V _I	Voltage limits for input pins STBY, MUTE, INNA, INPA, INNB, INPB, GAIN0, GAIN1	-0.3 - 3.6	V
T _{op}	Operating temperature	-40 to 85	°C
T _j	Junction temperature	-40 to 150	°C
T _{stg}	Storage temperature	-40 to 150	°C

Table 4. Thermal data

Symbol	Parameter	Min.	Typ.	Max.	Unit
R _{th j-case}	Thermal resistance, junction-to-case		2	3	°C/W
R _{th j-amb}	Thermal resistance, junction-to-ambient (mounted on a recommended PCB) ⁽¹⁾ .		24		

1. FR4 with vias to copper area of 9 cm²

4 Electrical specifications

Unless otherwise stated, the results in Table 1 below are given for the conditions: $V_{CC} = 18\text{ V}$, R_L (load) = $8\ \Omega$, $R_{OSC} = R_3 = 39\text{ k}\Omega$, $C_8 = 100\text{ nF}$, $f = 1\text{ kHz}$, $G_V = 20\text{ dB}$ and $T_{amb} = 25\text{ }^\circ\text{C}$.

Table 5. Electrical specifications

Symbol	Parameter	Test conditions	Min.	Typ.	Max.	Unit
V_{CC}	Supply voltage		5	-	18	V
I_q	Total quiescent current		-	26	35	mA
I_{qSTBY}	Quiescent current in standby			2.5	5.0	μA
V_{OS}	Output offset voltage	Play mode	-100		+100	mV
		Mute mode	-60		+60	
I_{OCP}	Overcurrent protection threshold	$R_L = 0\ \Omega$	3	5	-	A
T_j	Junction temperature at thermal shutdown			150		$^\circ\text{C}$
R_i	Input resistance	Differential input	54	60		k Ω
V_{UVP}	Undervoltage protection threshold	-			4.5	V
$R_{DS(on)}$	Power transistor on resistance	High-side		0.2		Ω
		Low-side		0.2		
P_o	Output power	THD = 10%		20		W
		THD = 1%		16		
P_o	Output power	$R_L = 8\ \Omega$, THD = 10%, $V_{CC} = 12\text{ V}$		7.2		W
		$R_L = 6\ \Omega$, THD = 1% $V_{CC} = 25\text{ V}$		4.0		
P_D	Dissipated power	$P_o = 20\text{W} + 20\text{ W}$, THD = 10%		4.0		W
η	Efficiency	$P_o = 20\text{ W} + 20\text{ W}$	80	90		%
THD	Total harmonic distortion	$P_o = 1\text{ W}$		0.1		%
G_V	Closed-loop gain	GAIN0 = L, GAIN1 = L	18	20	22	dB
		GAIN0 = L, GAIN1 = H	24	26	28	
		GAIN0 = H, GAIN1 = L	28	30	32	
		GAIN0 = H, GAIN1 = H	30	32	34	
ΔG_V	Gain matching		-1		+1	dB
CT	Cross-talk	$f = 1\text{ kHz}$, $P_o = 1\text{ W}$		70		dB
eN	Total input noise	A curve, $G_V = 20\text{ dB}$		20		μV
		$f = 22\text{ Hz to } 22\text{ kHz}$	-	25	35	
SVRR	Supply voltage rejection ratio	$f_r = 100\text{ Hz}$, $V_r = 1\text{ V}_{pp}$, $C_{SVR} = 10\ \mu\text{F}$		50		dB
T_r, T_f	Rise and fall times			40		ns
f_{sw}	Switching frequency	Internal oscillator, master mode	290	320	350	kHz

Symbol	Parameter	Test conditions	Min.	Typ.	Max.	Unit
f_{SWR}	Switching frequency range	(1)	250	-	400	kHz
V_{inH}	Digital input high (H)	-	2.3			V
V_{inL}	Digital input low (L)				0.8	
A_{MUTE}	Mute attenuation	$V_{\text{MUTE}} = \text{low}$, $V_{\text{STBY}} = \text{high}$		80		dB
Function mode	Standby mode	$V_{\text{STBY}} < 0.5 \text{ V}$ $V_{\text{MUTE}} = \text{X}$				
	Mute mode	$V_{\text{STBY}} > 2.9 \text{ V}$ $V_{\text{MUTE}} < 0.8 \text{ V}$				
	Play mode	$V_{\text{STBY}} > 2.9 \text{ V}$ $V_{\text{MUTE}} > 2.9 \text{ V}$				

1. Refer to Section 8.4 Internal and external clocks.

5 Characterization curves

The following characterization curves have been produced by using the TDA7491HV evaluation board.

The LC filter for 4 Ω load uses components of 15 μH and 470 nF, whilst that for 6 Ω load uses 22 μH and 220 nF and that for 8 Ω load uses 33 μH and 220 nF.

5.1 4 Ω loads at V_{CC} = 14 V

Figure 4. Output power vs. supply voltage

<p>Test Condition :</p> <p>V_{CC} = 5~14V,</p> <p>R_L = 4 ohm,</p> <p>R_{osc} = 39kΩ, C_{osc} = 100nF,</p> <p>f = 1kHz,</p> <p>G_v = 30dB,</p> <p>T_{amb} = 25°C</p> <p>Specification Limit:</p> <p>Typical:</p> <p>V_s = 14V, R_L = 4 ohm</p> <p>P_o = 20W @THD = 10%</p> <p>P_o = 16W @THD = 1%</p>

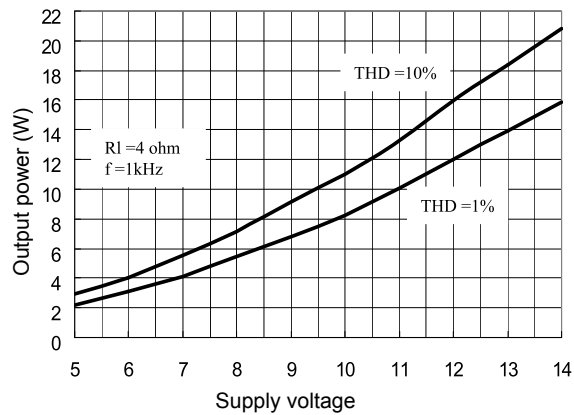

Figure 5. THD vs. output power (1 kHz)

<p>Test Condition:</p> <p>V_{CC} = 14V,</p> <p>R_L = 4 ohm,</p> <p>R_{osc} = 39kΩ, C_{osc} = 100nF,</p> <p>f = 1kHz,</p> <p>G_v = 30dB,</p> <p>T_{amb} = 25°C</p> <p>Specification Limit:</p> <p>Typical:</p> <p>P_o = 20W @ THD = 10%</p>
--

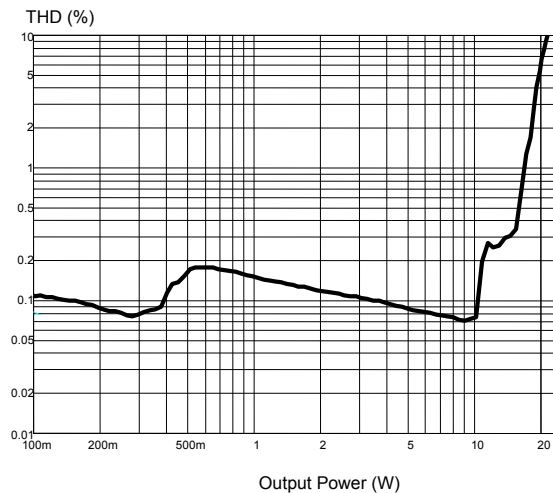

Figure 6. THD vs. output power (100 Hz)

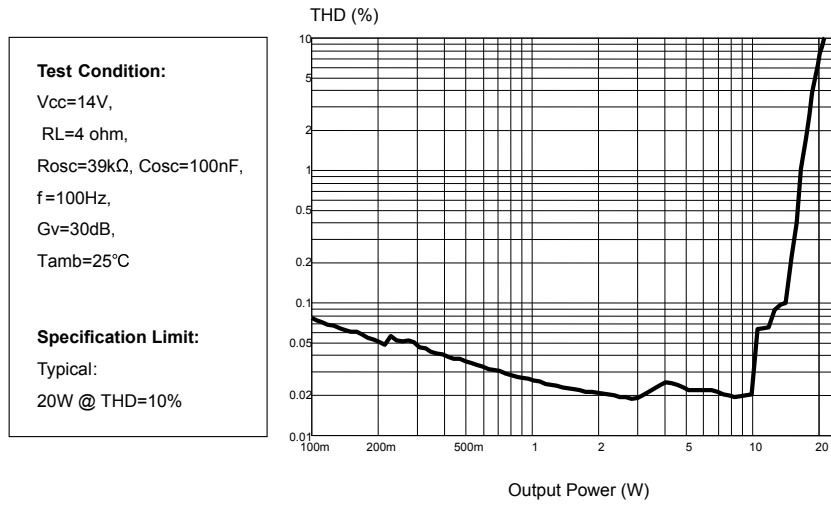

Figure 7. THD vs. frequency

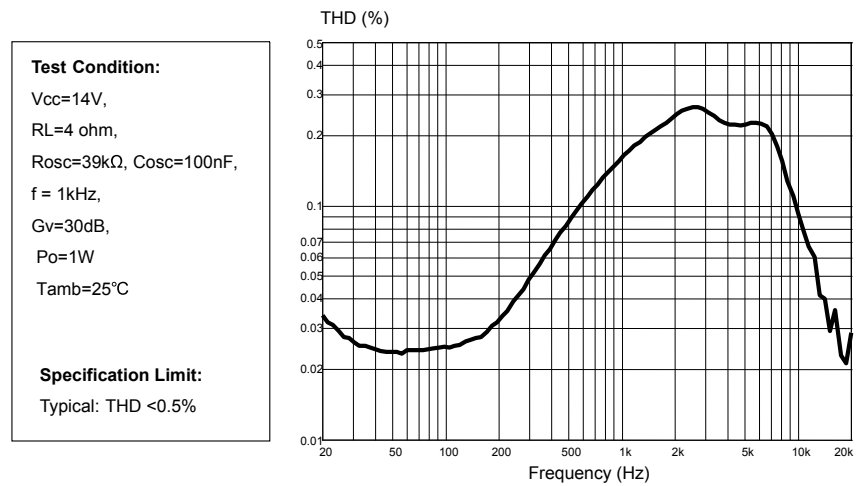

Figure 8. Frequency response

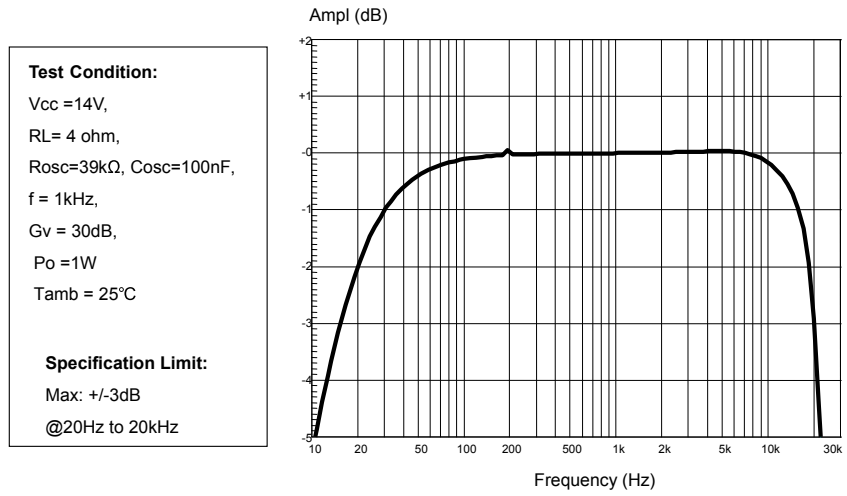

Figure 9. Crosstalk vs. frequency

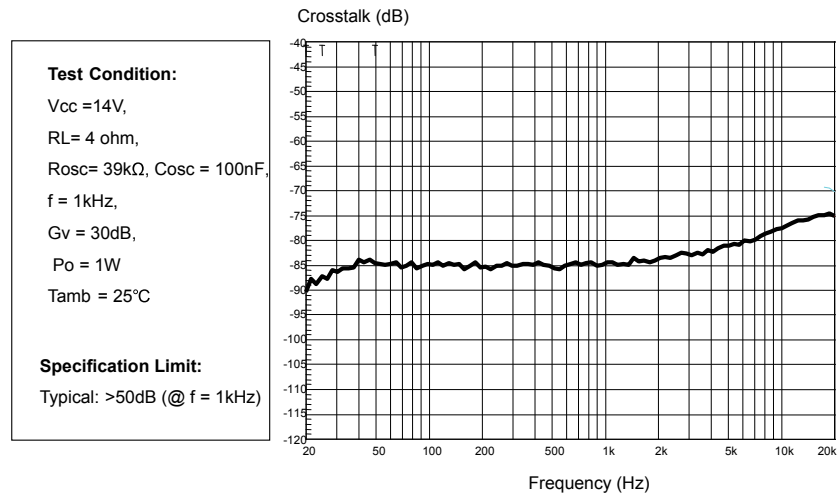

Figure 10. FFT performance (0 dB)

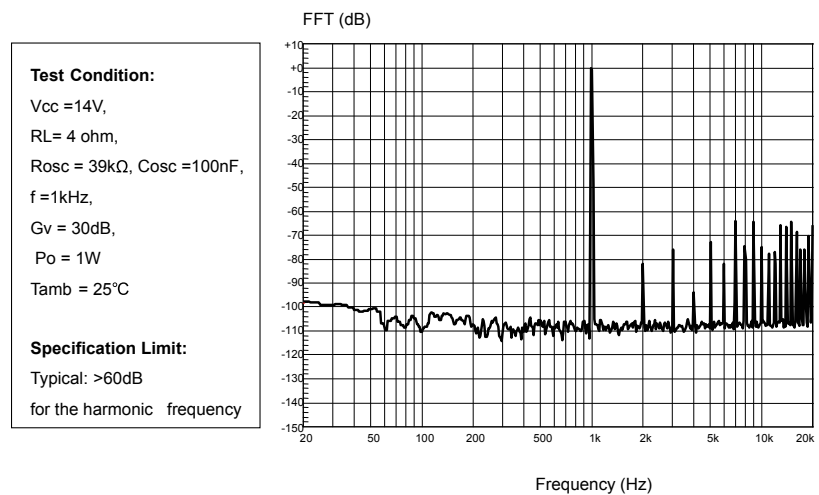

Figure 11. FFT performance (-60 dB)

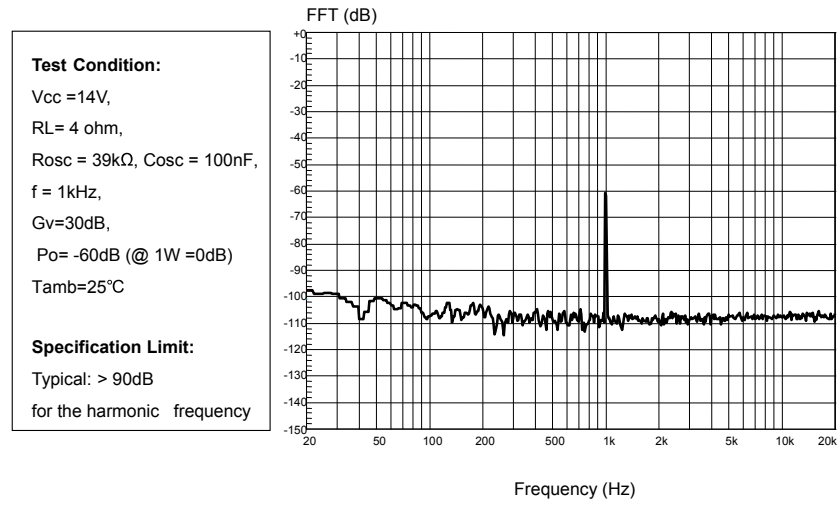

Figure 12. Power supply rejection ratio vs. frequency

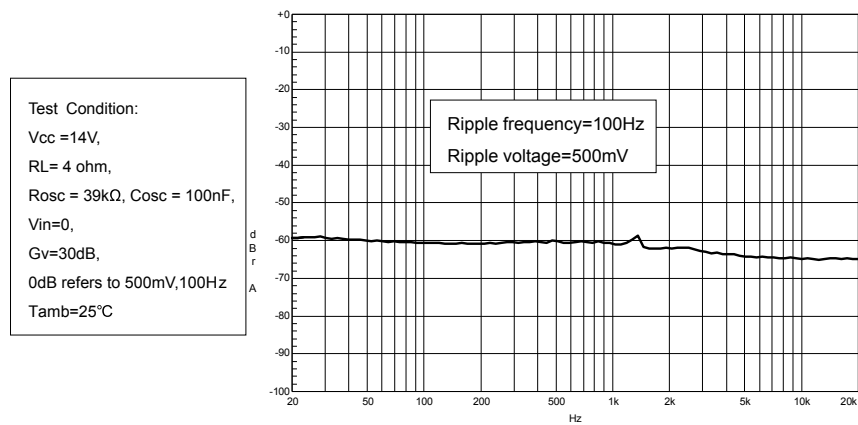

Figure 13. Power dissipation and efficiency vs. output power

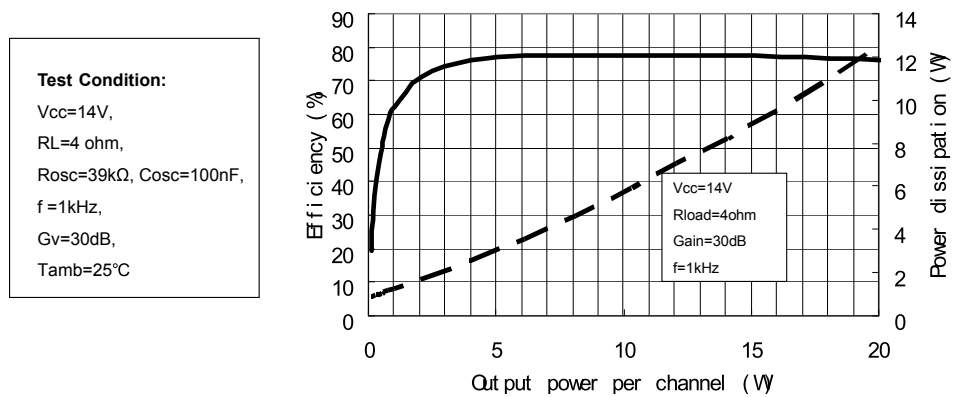

Figure 14. Closed-loop gain vs. frequency

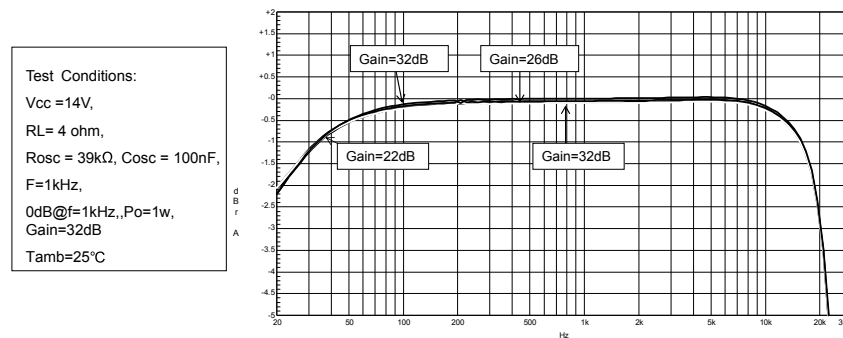

Figure 15. Current consumption vs. voltage on pin MUTE

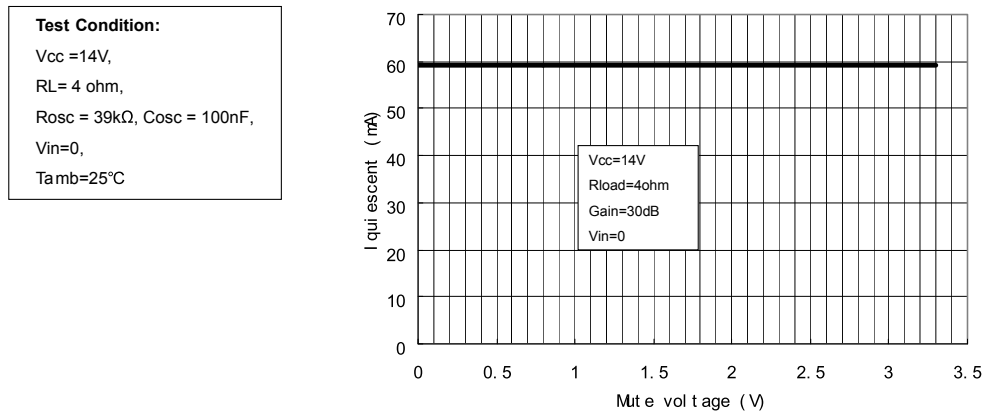

Figure 16. Attenuation vs. voltage on pin MUTE

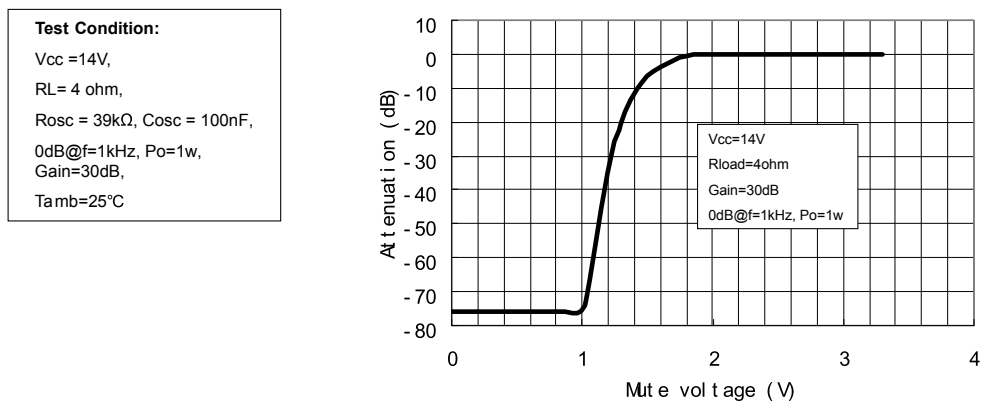

Figure 17. Current consumption vs. voltage on pin STBY

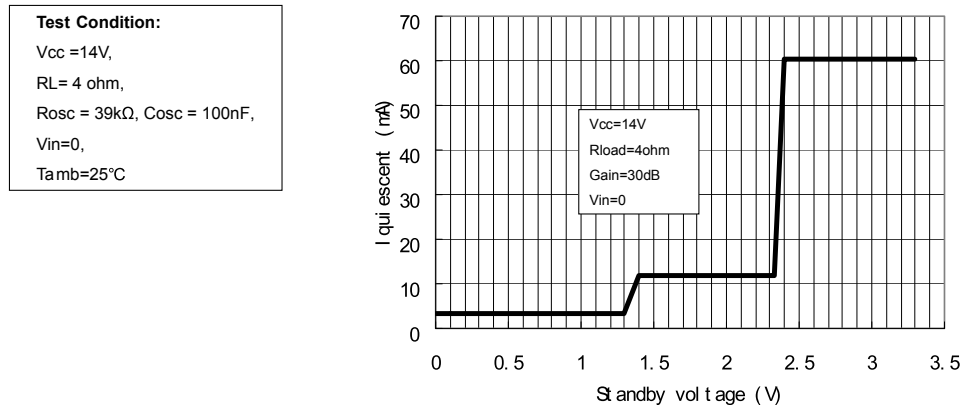
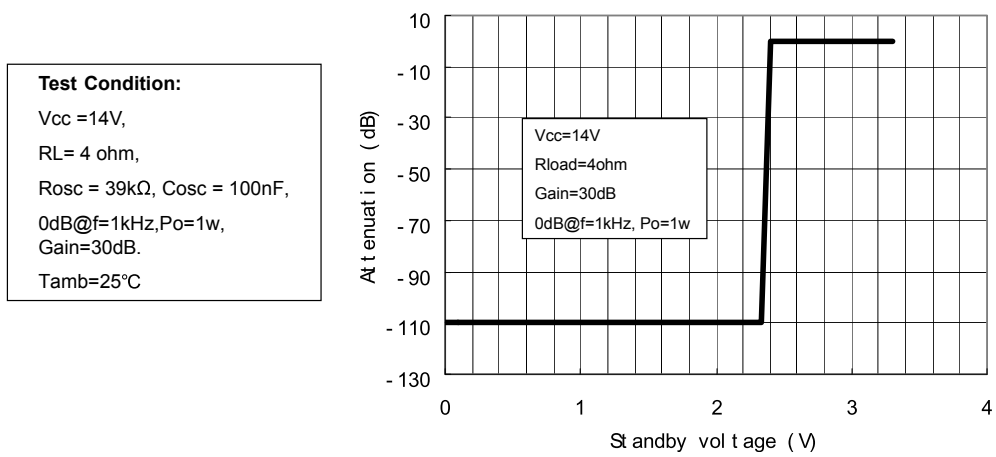

Figure 18. Attenuation vs. voltage on pin STBY



5.2 6 Ω loads at V_{CC} = 16 V

Figure 19. Output power vs. supply voltage

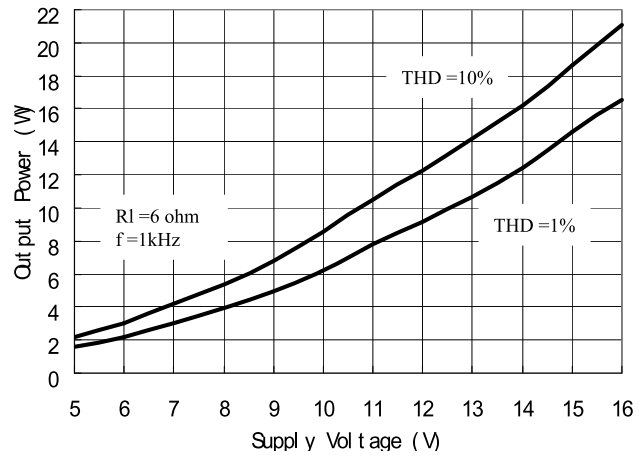
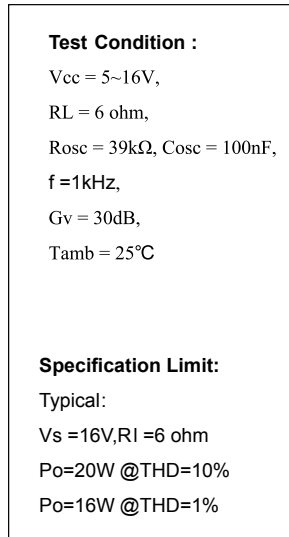

Figure 20. THD vs. output power (1 kHz)

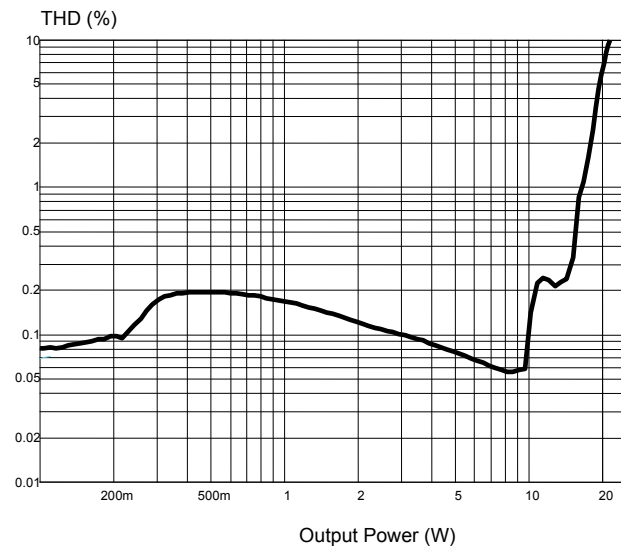
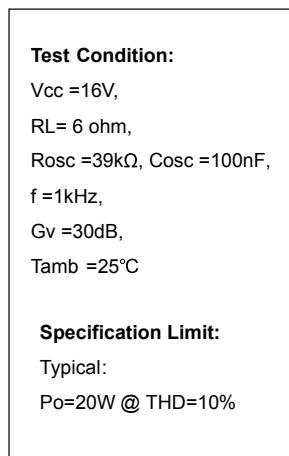

Figure 21. THD vs. output power (100 Hz)

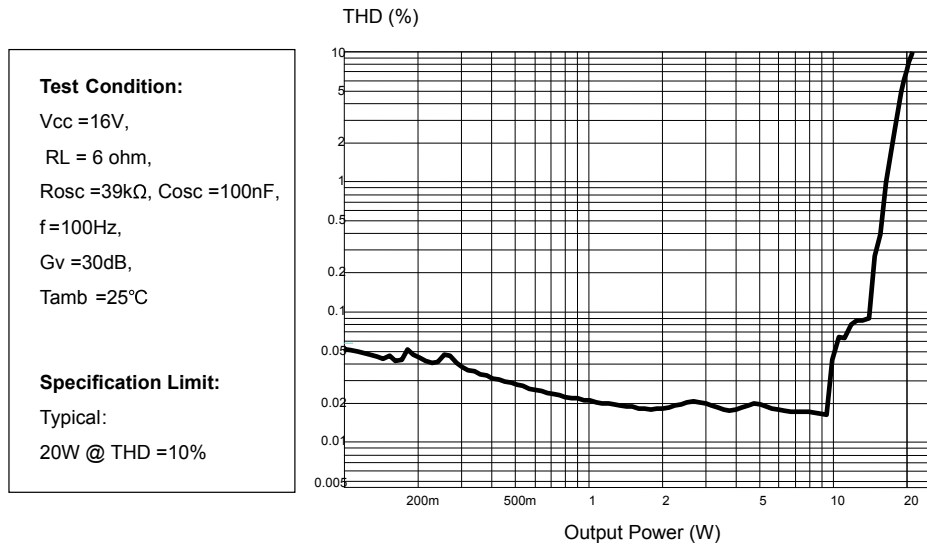

Figure 22. THD vs. frequency

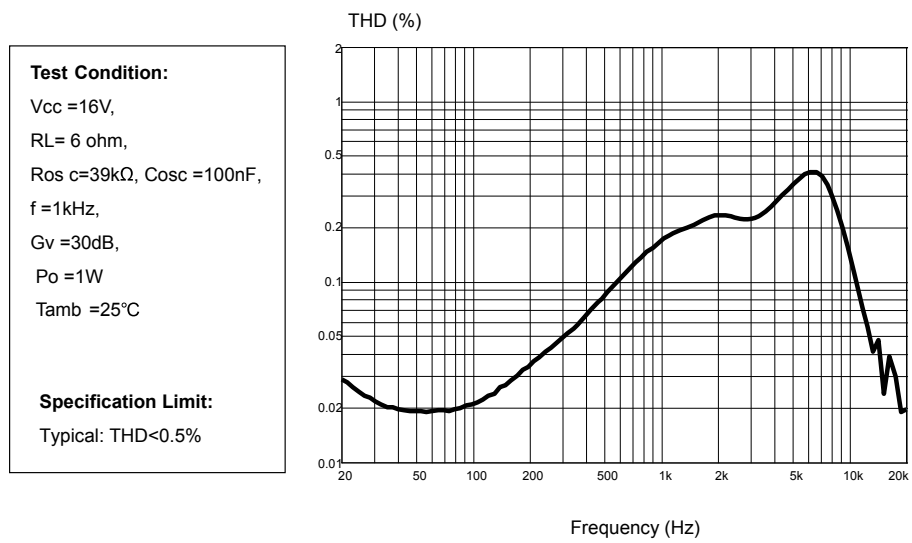

Figure 23. Frequency response

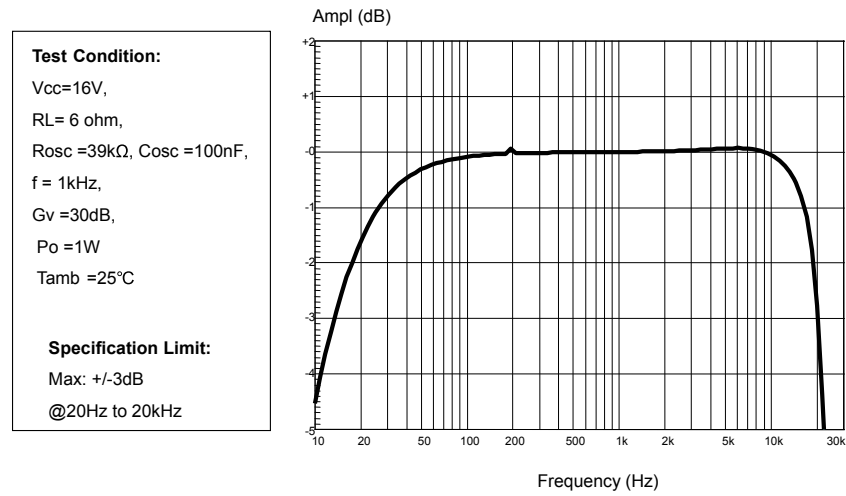

Figure 24. Crosstalk vs. frequency

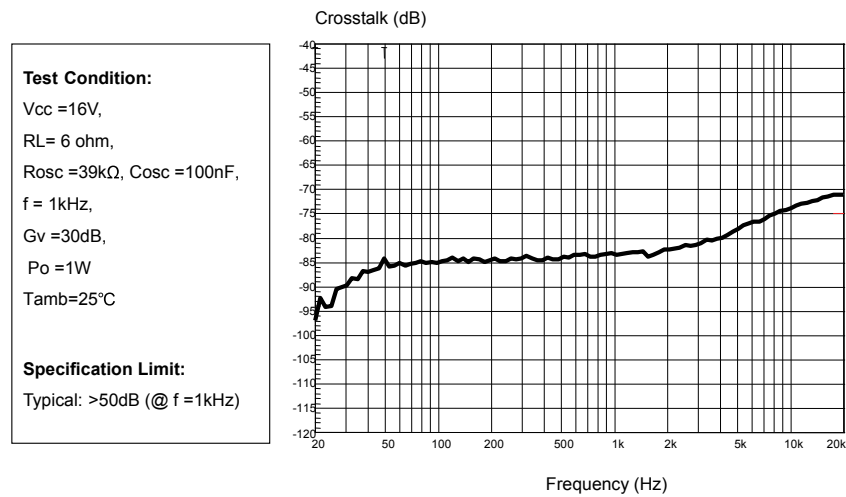

Figure 25. FFT performance (0 dB)

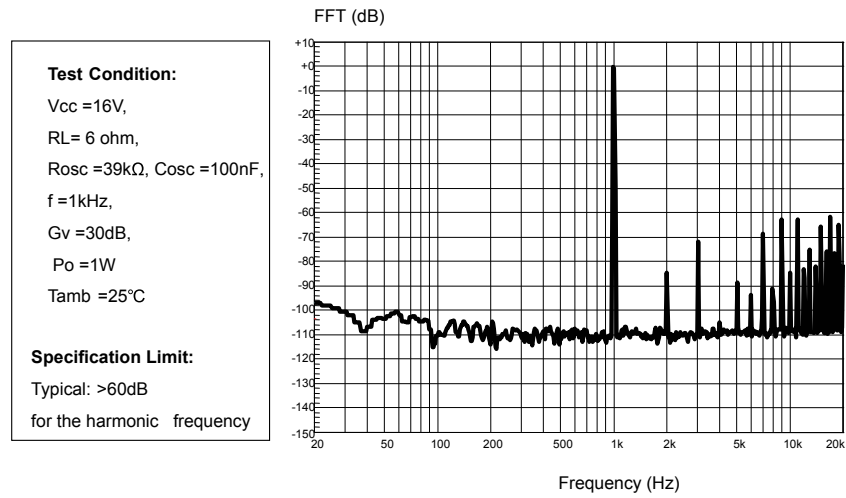

Figure 26. FFT performance (-60 dB)

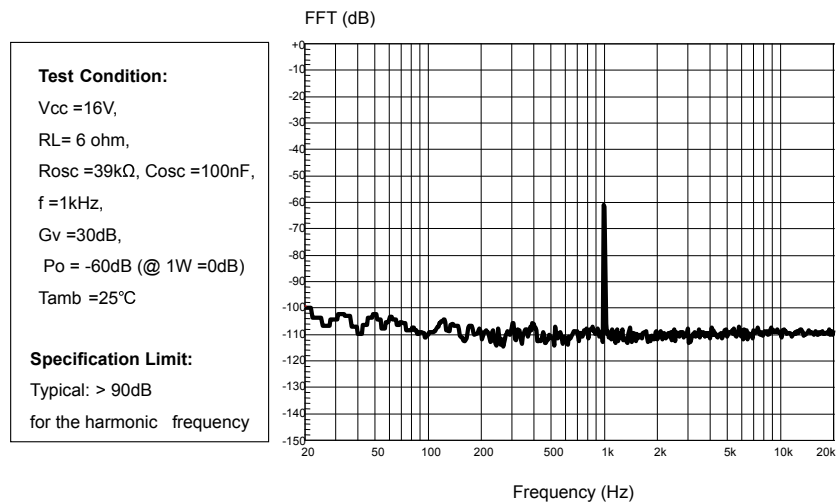

Figure 27. Power supply rejection ratio vs. frequency

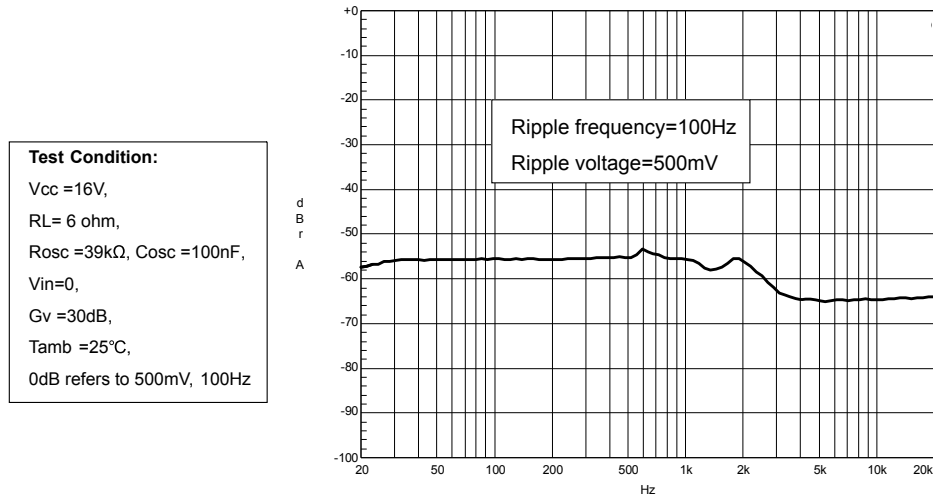

Figure 28. Power dissipation and efficiency vs. output power

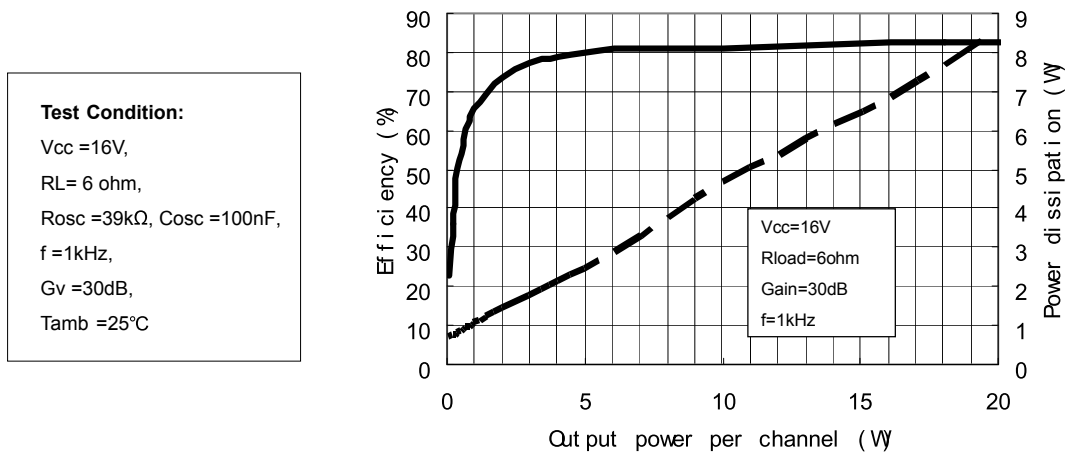

Figure 29. Closed-loop gain vs. frequency

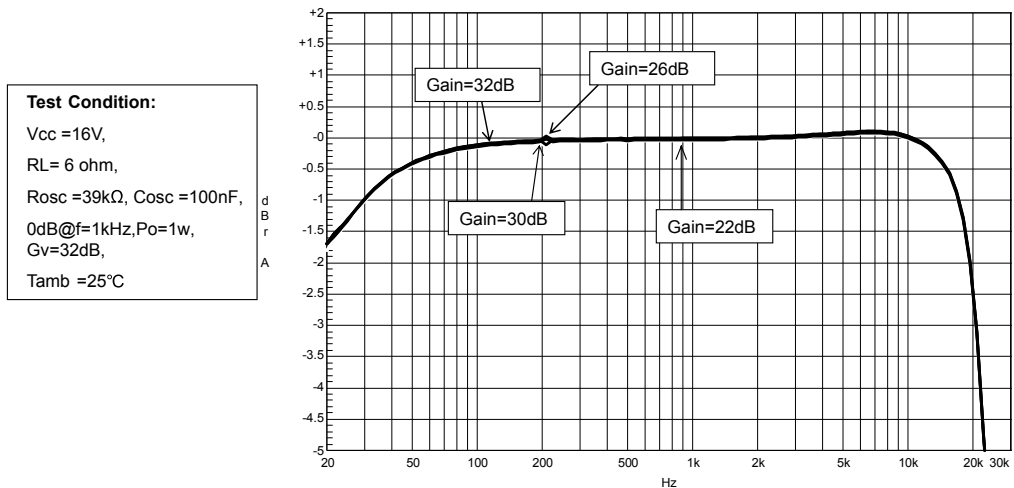

Figure 30. Current consumption vs. voltage on pin MUTE

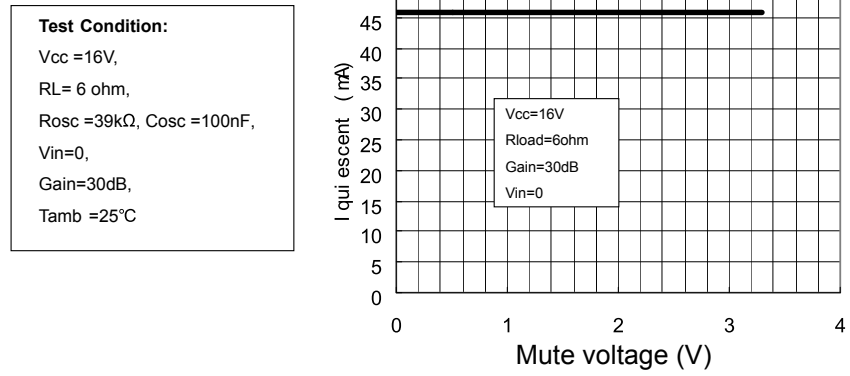

Figure 31. Attenuation vs. voltage on pin MUTE

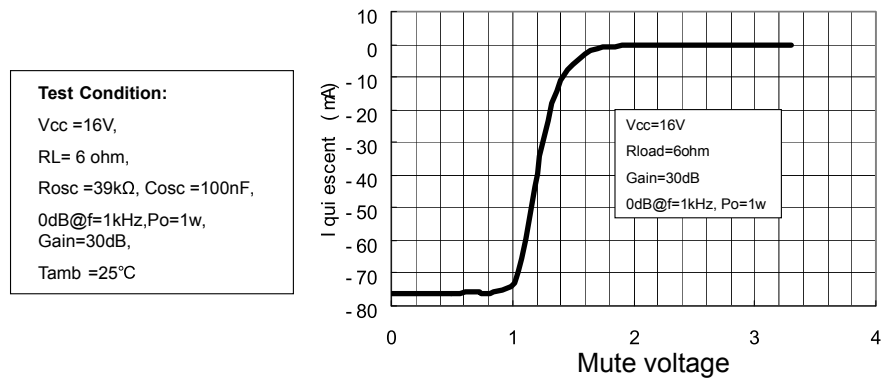

Figure 32. Current consumption vs. voltage on pin STBY

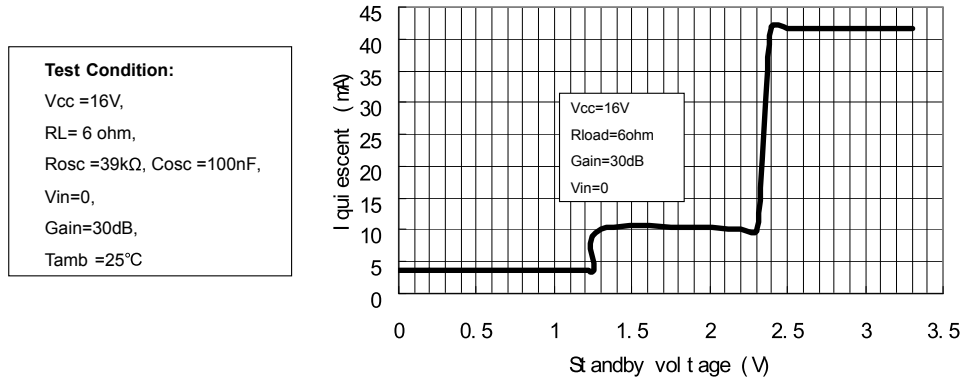
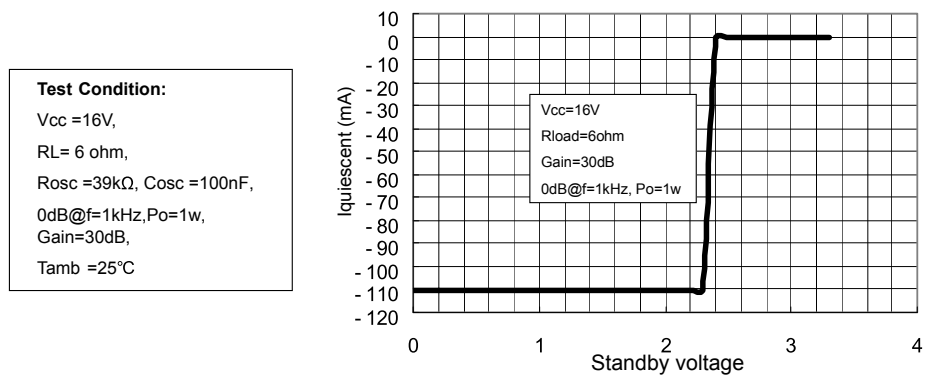

Figure 33. Attenuation vs. voltage on pin STBY



5.3 8 Ω loads at V_{CC} = 18 V

Figure 34. Output power vs. supply voltage

Test conditions :

V_{CC} = 5~18V,
R_L = 8 ohm,
R_{osc} =39kΩ, C_{osc} =100nF
f =1kHz,
G_v =30dB,
T_{amb} =25°C

Specification limit:

Typical:
V_s =18V, R_L = 8 ohm
P_o =20W @THD =10%
P_o =16W @THD =1%

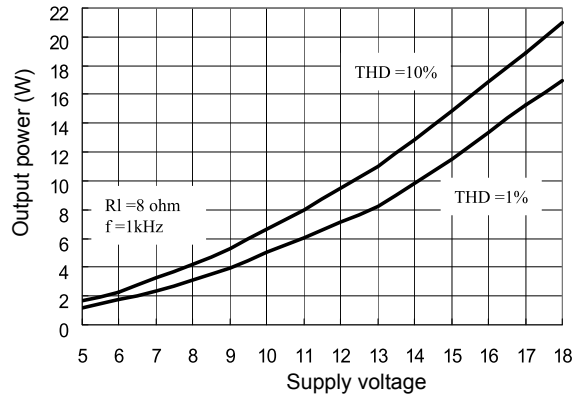

Figure 35. THD vs. output power (1 kHz)

Test Condition:

V_{CC} =18V,
R_L = 8 ohm,
R_{osc} =39kΩ, C_{osc} =100nF,
f =1kHz,
G_v =30dB,
T_{amb} =25°C

Specification Limit:

Typical:
P_o =20W @ THD =10%

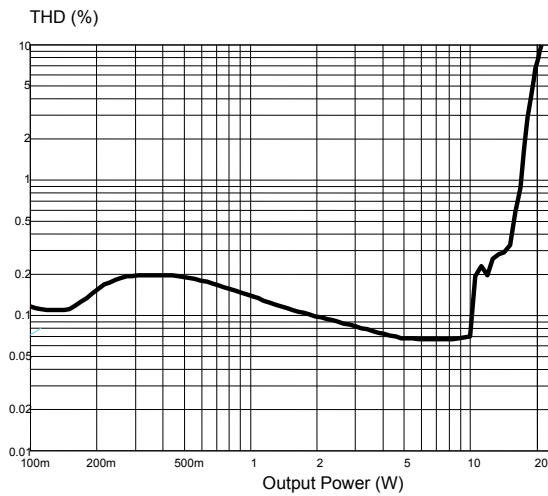

Figure 36. THD vs. output power (100 Hz)

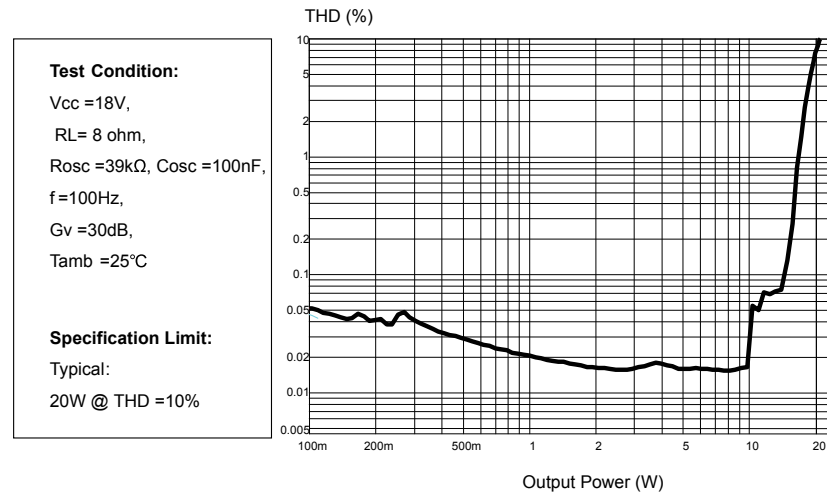

Figure 37. THD vs. frequency

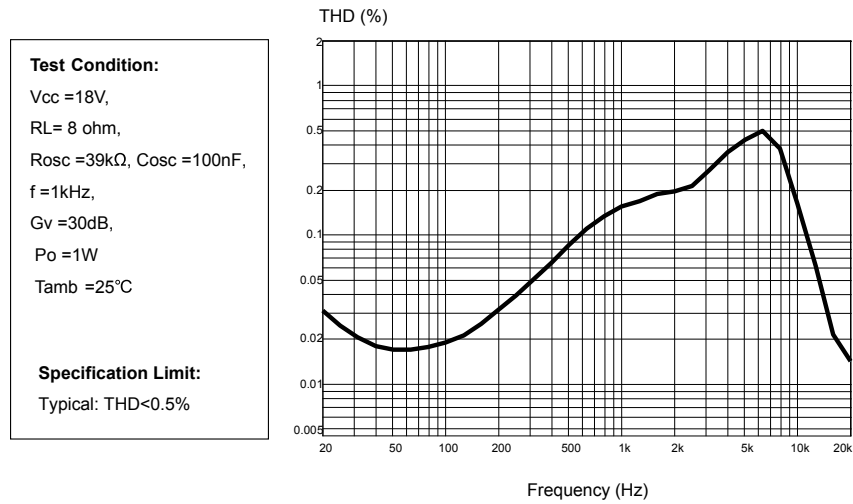

Figure 38. Frequency response

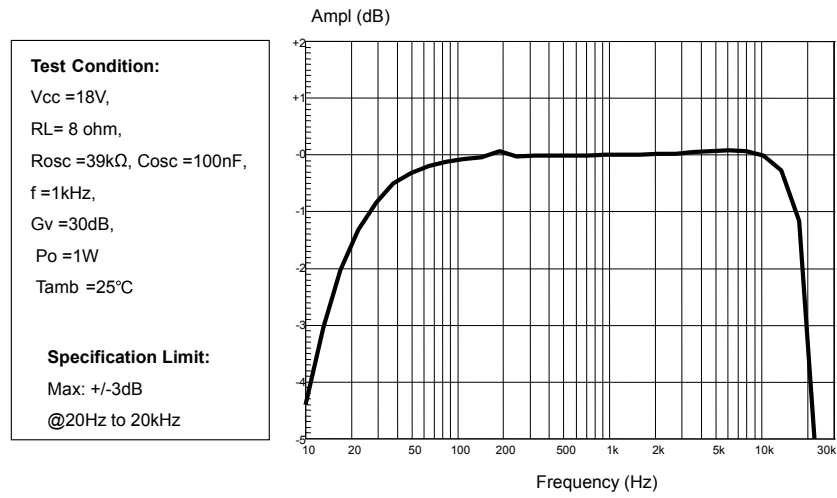

Figure 39. Crosstalk vs. frequency

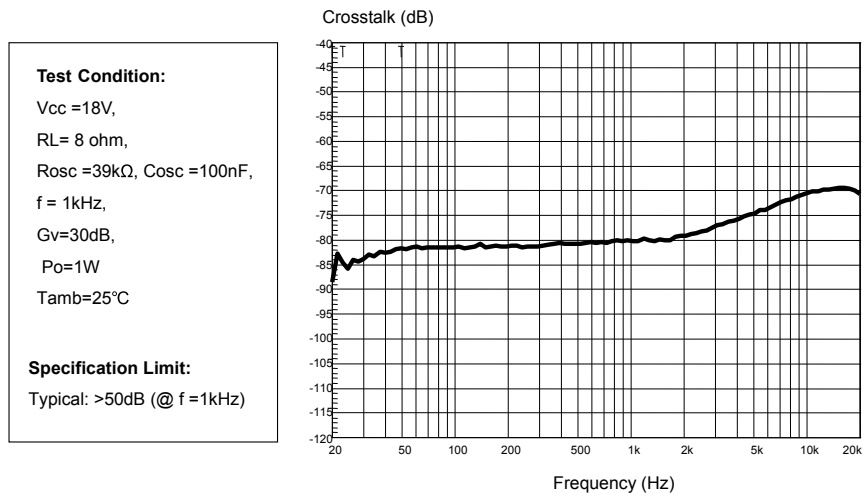

Figure 40. FFT performance (0 dB)

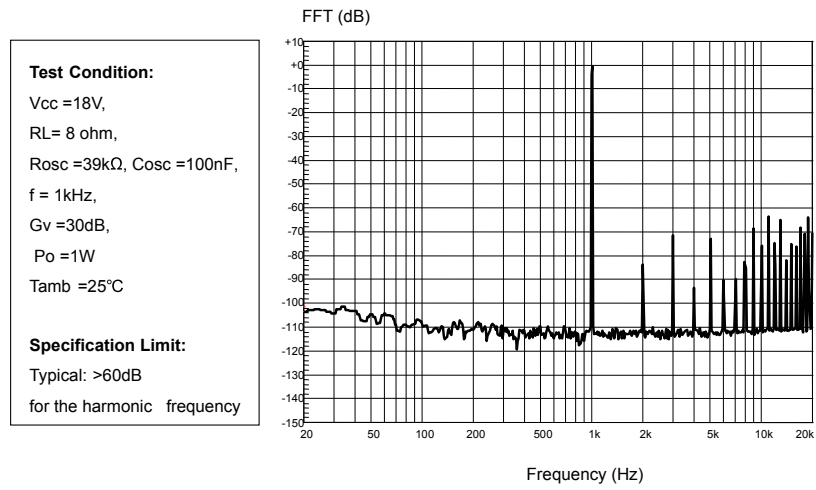

Figure 41. FFT performance (-60 dB)

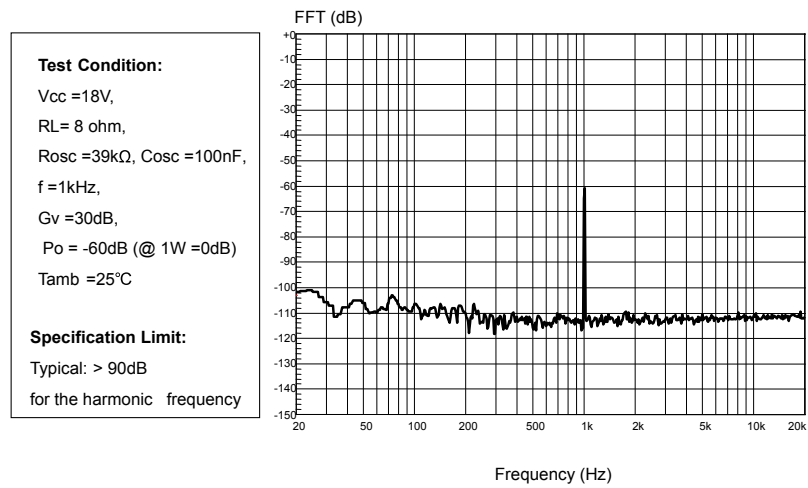

Figure 42. Power supply rejection ratio vs. frequency

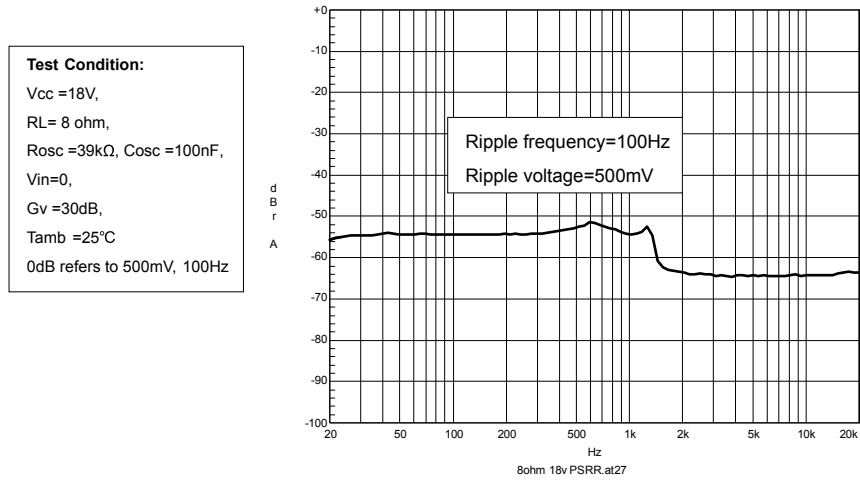

Figure 43. Power dissipation and efficiency vs. output power

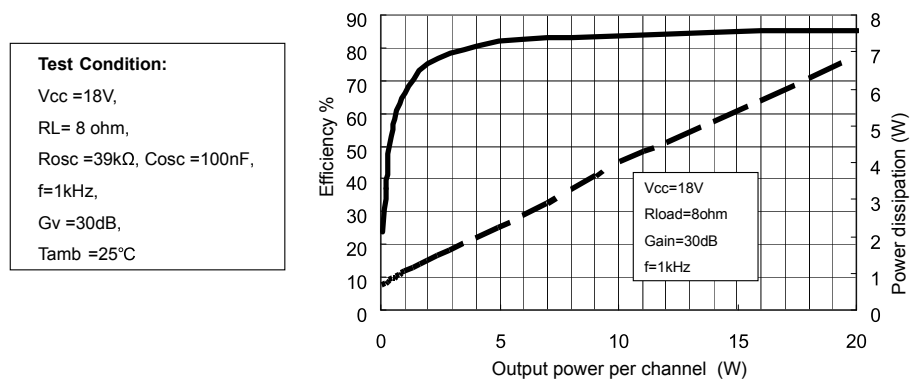

Figure 44. Closed-loop gain vs. frequency

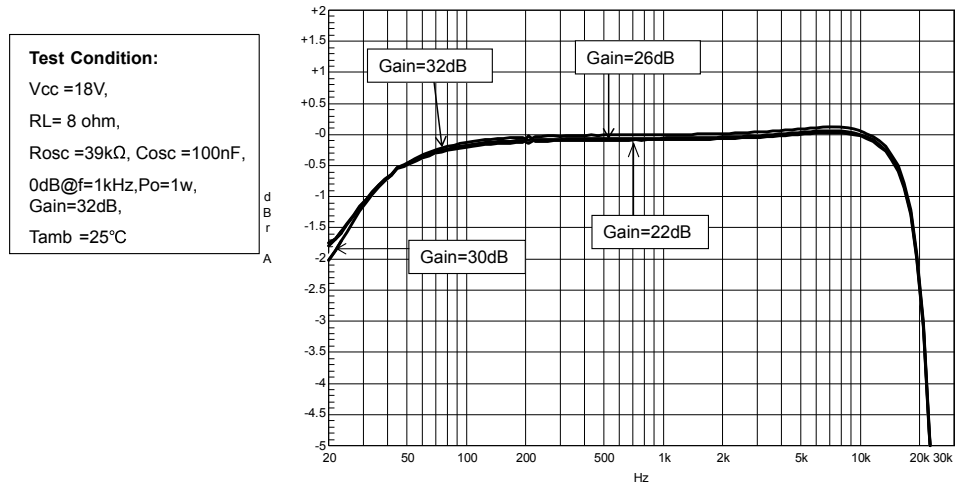

Figure 45. Current consumption vs. voltage on pin MUTE

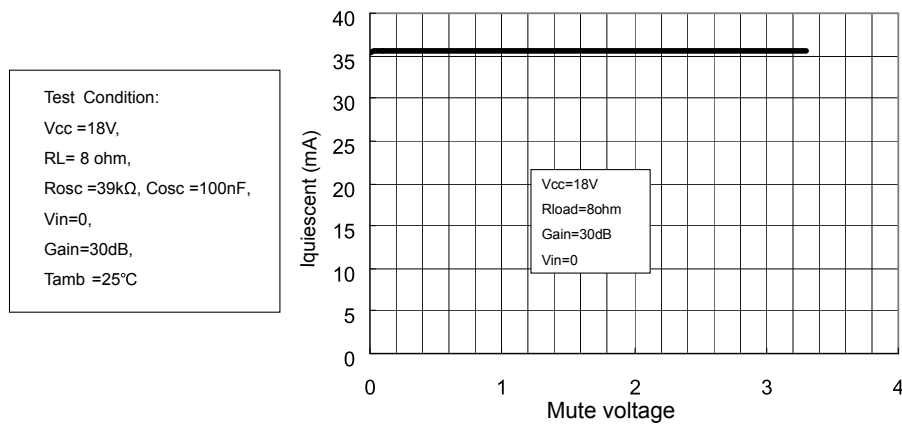

Figure 46. Attenuation vs. voltage on pin MUTE

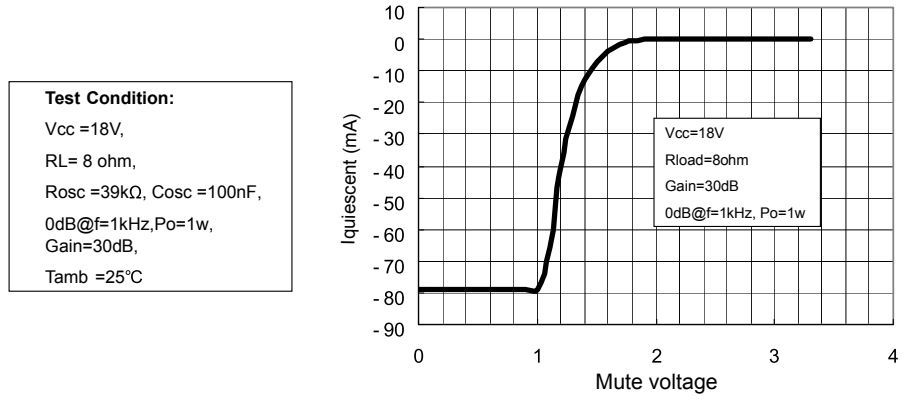

Figure 47. Current consumption vs. voltage on pin STBY

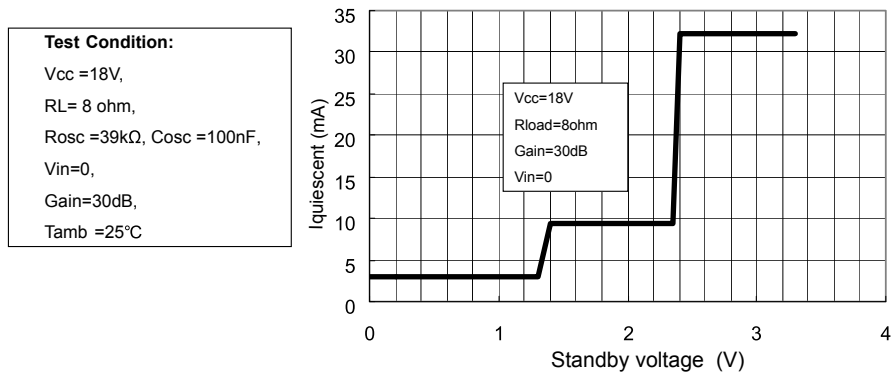
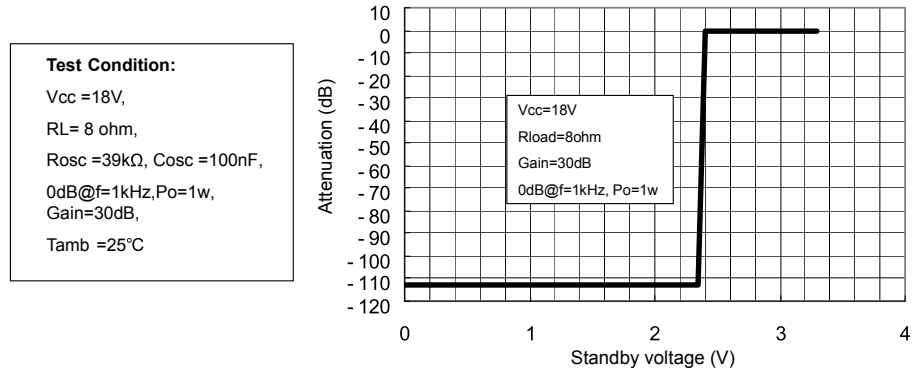
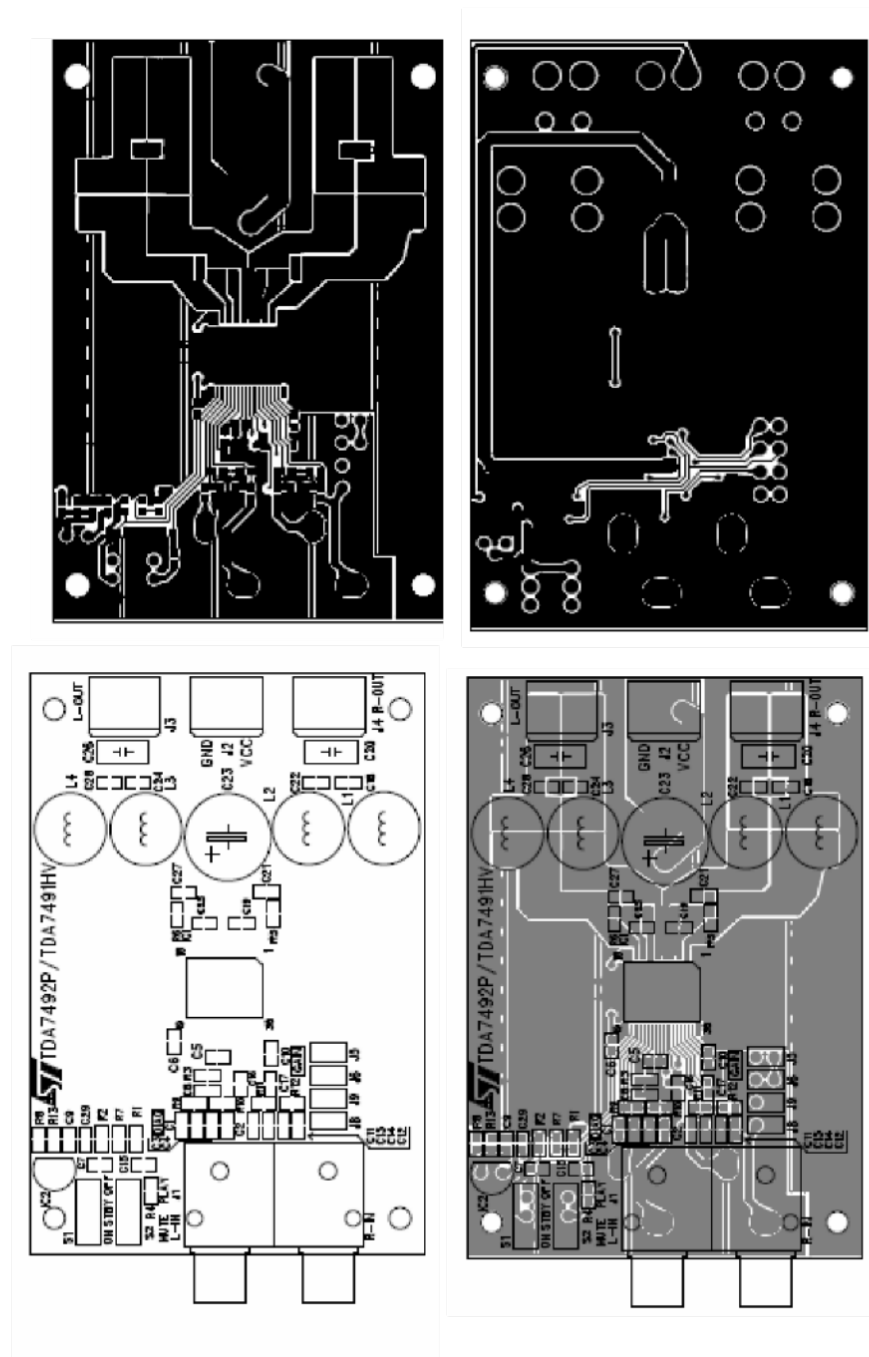

Figure 48. Attenuation vs. voltage on pin STBY



6 Test board

Figure 49. Test board (TDA7491HV) layout



7 Application circuit

Figure 50. Application circuit for class-D amplifier

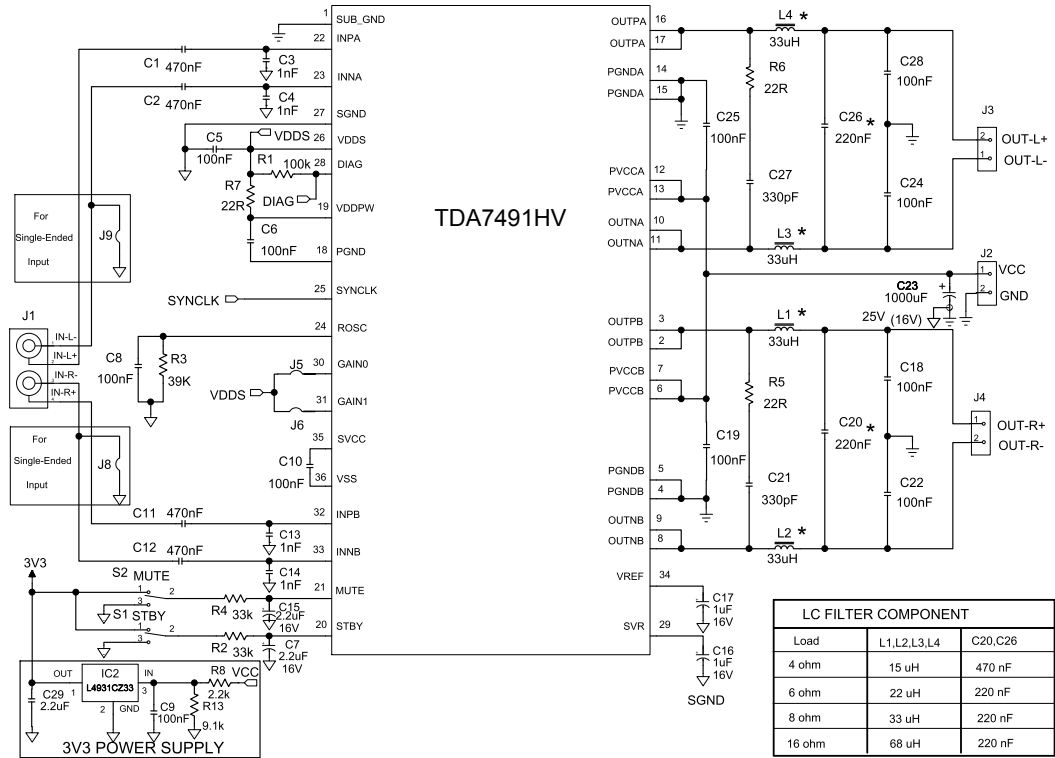

8 Application information

8.1 Mode selection

The three operating modes of the TDA7491HV are set by the two inputs, STBY (pin 20) and MUTE (pin 21).

- Standby mode: all circuits are turned off, very low current consumption.
- Mute mode: inputs are connected to ground and the positive and negative PWM outputs are at 50% duty cycle.
- Play mode: the amplifiers are active.

The protection functions of the TDA7491HV are enabled by pulling down the voltages of the STBY and MUTE inputs shown in figure below. The input current of the corresponding pins must be limited to 200 μ A.

Table 6. Mode settings

Mode	STBY	MUTE
Standby	L ⁽¹⁾	X (do not care)
Mute	H ⁽¹⁾	L
Play	H	H

1. Refer to V_{STBY} and V_{MUTE} in Section 4 Electrical specifications

Figure 51. Standby and mute circuits

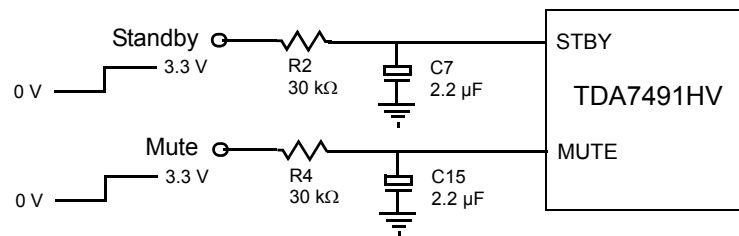
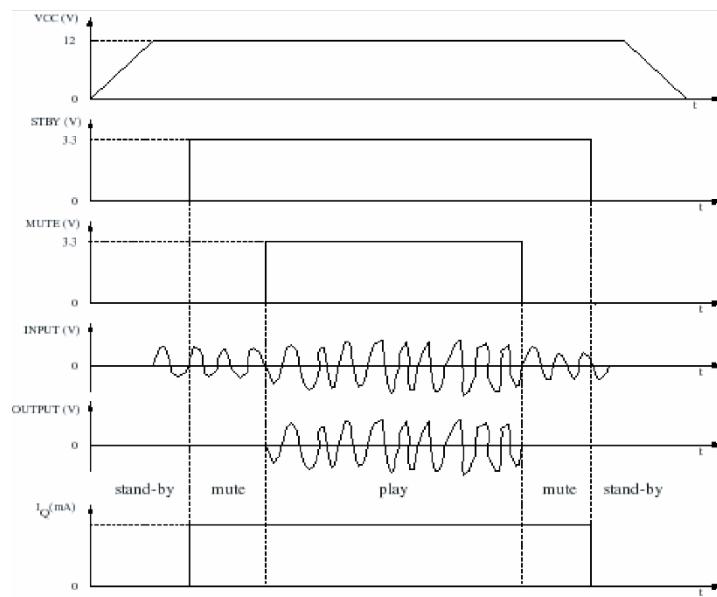

Figure 52. Turn-on/off sequence for minimizing speaker “pop”



8.2 Gain setting

The gain of the TDA7491HV is set by the two inputs, GAIN0 (pin 30) and GAIN1 (pin31). Internally, the gain is set by changing the feedback resistors of the amplifier.

Table 7. Gain settings

GAIN0	GAIN1	Nominal gain, G _v (dB)
L ⁽¹⁾	H ⁽¹⁾	20
L	H	26
H	L	30
H	H	32

1. Refer to Section 4 Electrical specifications for L and H drive levels.

8.3 Input resistance and capacitance

The input impedance is set by an internal resistor $R_i = 68 \text{ k}\Omega$ (typical). An input capacitor (C_i) is required to couple the AC input signal.

The equivalent circuit and frequency response of the input components are shown in figure below. For $C_i = 220 \text{ nF}$, the high-pass filter cut-off frequency is below 20 Hz:

$$f_c = 1 / (2 * \pi * R_i * C_i)$$

Figure 53. Device input circuit and frequency response

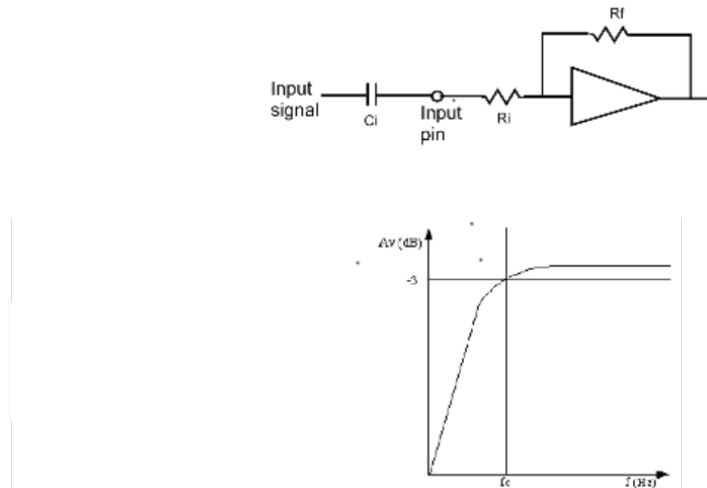

8.4 Internal and external clocks

The clock of the class-D amplifier can be generated internally or can be driven by an external source.

If two or more class-D amplifiers are used in the same system, it is recommended that all the devices operate at the same clock frequency. This can be implemented by using one TDA7491HV as master clock, while the other devices are in slave mode, that is, externally clocked. The clock interconnect is via pin SYNCLK of each device. As explained below, SYNCLK is an output in master mode and an output in master mode and an input in slave mode.

8.4.1 Master mode (internal clock)

Using the internal oscillator, the output switching frequency, f_{SW} , is controlled by the resistor, R_{OSC} , connected to pin ROSC:

$$f_{SW} = 10^6 / ((16 * R_{OSC} + 182) * 4) \text{ kHz}$$

where R_{OSC} is in $\text{k}\Omega$.

In master mode, pin SYNCLK is used as a clock output pin whose frequency is:

$$f_{SYNCLK} = 2 * f_{SW}$$

For master mode to operate correctly, then resistor R_{OSC} must be less than 60 $\text{k}\Omega$ as given below in Table 8. How to set up SYNCLK.

8.4.2 Slave mode (external clock)

In order to accept an external clock input the pin ROSC must be left open, that is, floating. This forces pin SYNCLK to be internally configured as an input as given in table below.

The output switching frequency of the slave devices is:

$$f_{SW} = f_{SYNCLK} / 2$$

Table 8. How to set up SYNCLK

Mode	ROSC	SYNCLK
Master	$R_{OSC} < 60 \text{ k}\Omega$	Output
Slave	Floating (not connected)	Input

Figure 54. Master and slave connection

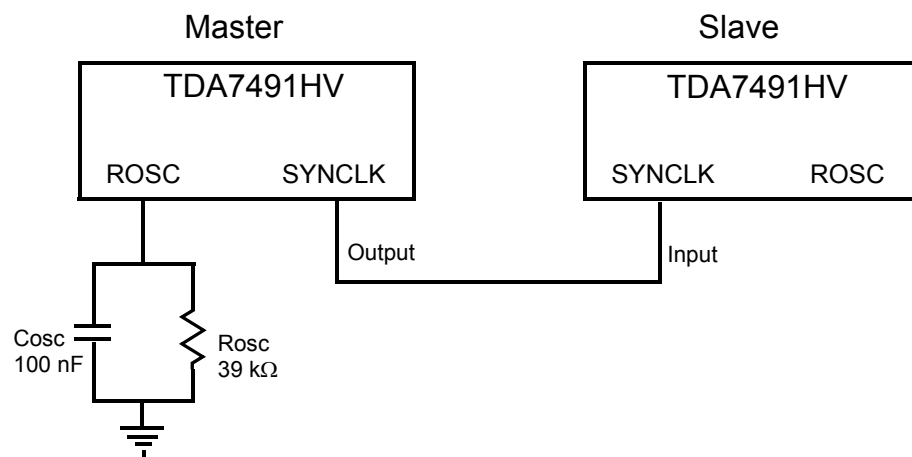

8.5 Modulation

The output modulation scheme of the BTL is called unipolar pulse width modulation (PWM).

The differential output voltages change between 0 V and $+V_{CC}$ and between 0 V and $-V_{CC}$.

This is in contrast to the traditional bipolar PWM outputs which change between $+V_{CC}$

and $-V_{CC}$. An advantage of this scheme is that it effectively doubles the switching frequency of the differential output waveform on the load then reducing the current ripple accordingly. The OUP and OUTN are in the same phase almost overlapped when the input is zero under this condition, then the switching current is low and the related losses in the load are low.

In practice, a short delay is introduced between these two outputs in order to avoid the BTL output switching simultaneously when the input is zero.

Figure below shows the resulting differential output voltage and current when a positive, zero and negative input signal is applied. The resulting differential voltage on the load has a double frequency with respect to outputs OUP and OUTN, resulting in reduced current ripple.

Figure 55. Unipolar PWM output

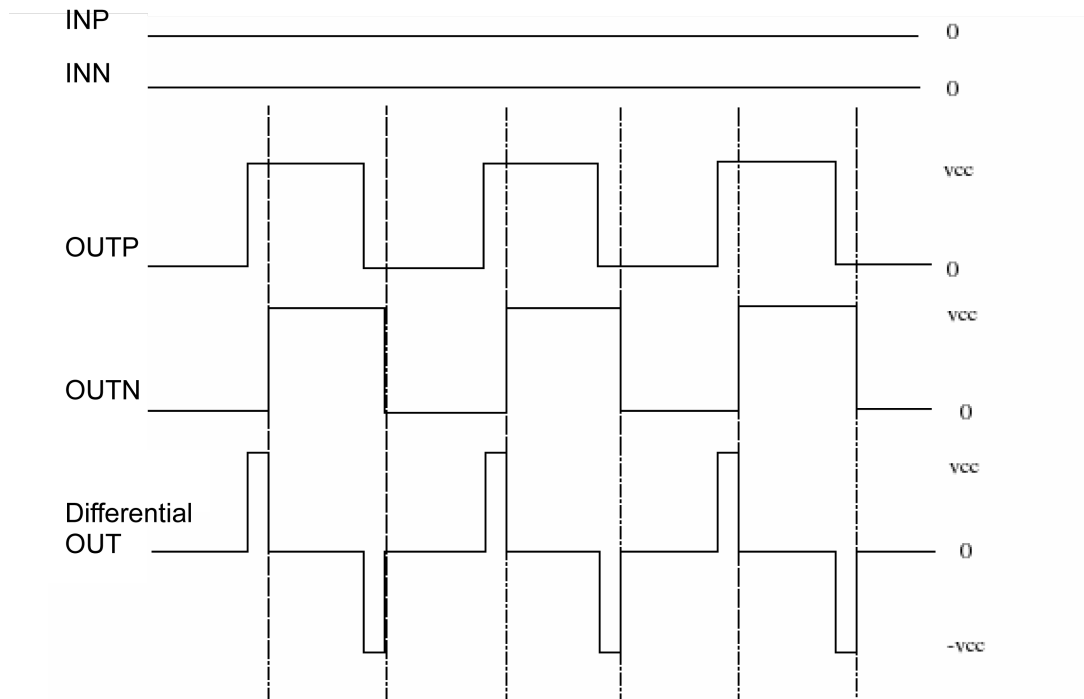

8.6 Reconstruction low-pass filter

Standard applications use a low-pass filter before the speaker. The cut-off frequency should be higher than 22 kHz and much lower than the output switching frequency. It is necessary to choose the L-C component values depending on the loud speaker impedance. Some typical values, which give a cut-off frequency of 27 kHz, are shown in figures below.

Figure 56. Typical LC filter for an 8 Ω speaker

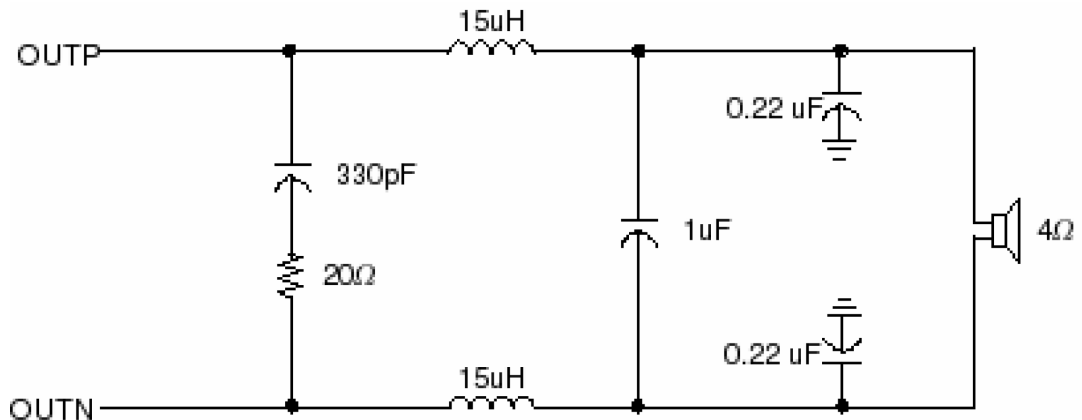
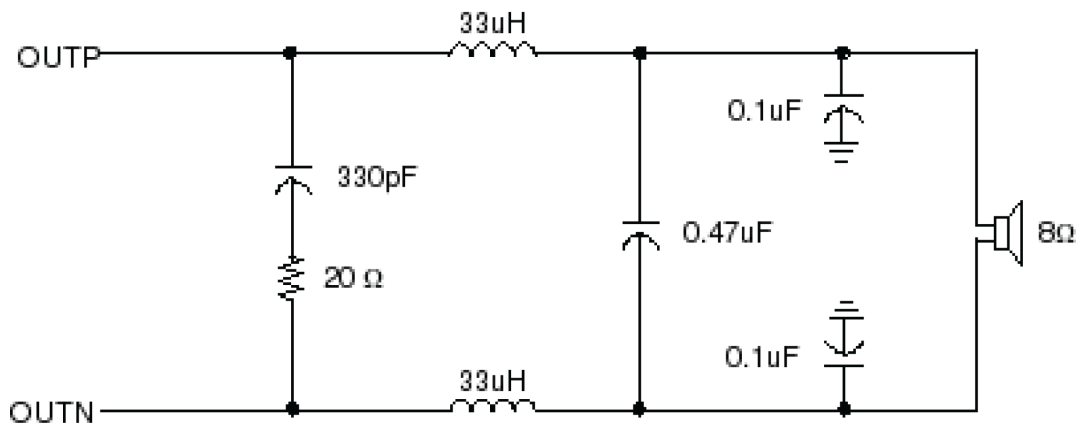

Figure 57. Typical LC filter for an 4 Ω speaker



8.7 Protection functions

The TDA7491HV is fully protected against undervoltage, overcurrent and thermal overloads as explained here.

Undervoltage protection (UVP)

If the supply voltage drops below the value of V_{UVP} given in Section 4 Electrical specifications the undervoltage protection is active and forces the outputs to the high-impedance state. When the supply voltage recovers, the device restarts.

Overcurrent protection (OCP)

If the output current exceeds the value for I_{OCP} given in Section 4 Electrical specifications, the overcurrent protection is active and forces the outputs to the high-impedance state. Periodically, the device tries to restart. If the overcurrent condition is still present then the OCP remains active. The restart time, T_{OC} , is determined by the R-C components connected to pin STBY.

Thermal protection (OTP)

If the junction temperature, T_j , reaches 145 °C (nominal), the device goes to mute mode and the positive and negative PWM outputs are forced to 50% duty cycle. If the junction temperature reaches the value for T_j , given in Section 4 Electrical specifications, the device shuts down and the output is forced to the high-impedance state. When the device cools sufficiently the device restarts.

8.8 Diagnostic output

The output pin DIAG is an open-drain transistor. When the protection is activated it is in the high-impedance state. The pin can be connected to a power supply (<18 V) by a pull-up resistor whose value is limited by the maximum sinking current (200 μA) of the pin.

Figure 58. Behavior of pin DIAG for various protection conditions

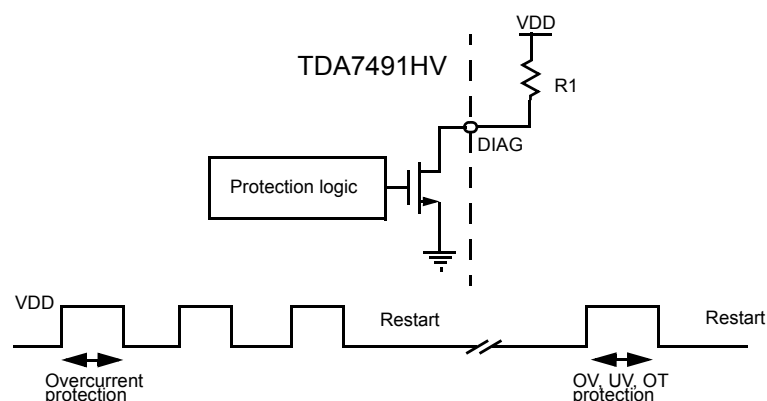

8.9 Heatsink requirements

Due to the high efficiency of the class-D amplifier a 2-layer PCB can easily provide the heatsinking capability for low to medium power outputs. Using such a PCB with a copper ground layer of 3x3 cm² and 16 vias connecting it to the contact area for the exposed pad, a thermal resistance, junction-to-ambient (in natural air convection), of 24 °C/W can be achieved.

The dissipated power within the device depends primarily on the supply voltage, load impedance and output modulation level. With the TDA7491HV driving 2 x 8 Ω with a supply of 18 V then the device dissipation is approximately 4 W that gives with the above mentioned PCB a junction temperature rise of about 90 °C.

With a musical program, the dissipated power is about 40% less than the above maximum value. This leads to a junction temperature increase of around 60 °C. So even at the maximum recommended ambient temperature there is a margin of safety before the maximum junction temperature is reached.

Figure below shows the derating curves for copper areas of 4 cm² and 9 cm².

Figure 59. Power derating curves for PCB used as heatsink

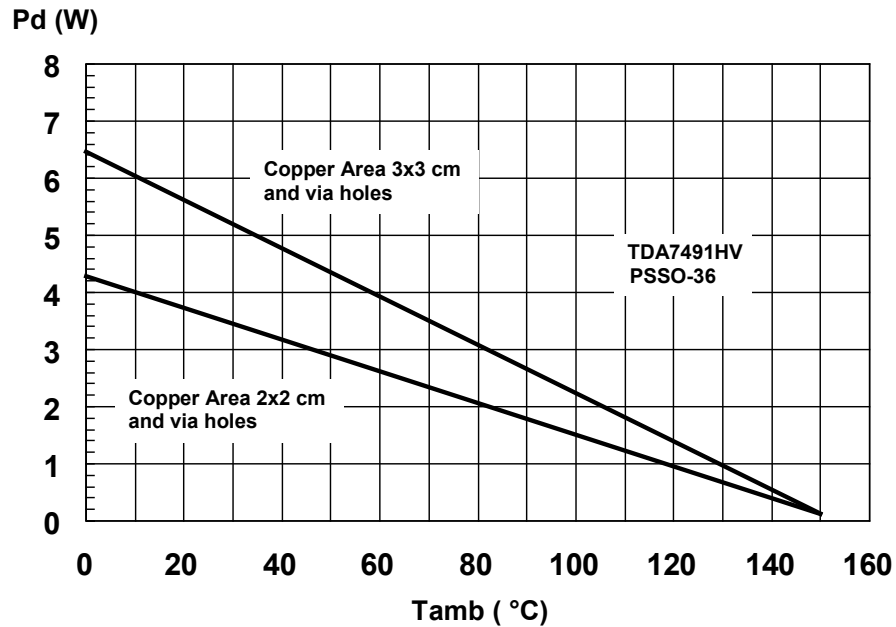

9 Package information

In order to meet environmental requirements, ST offers these devices in different grades of **ECOPACK** packages, depending on their level of environmental compliance. ECOPACK specifications, grade definitions and product status are available at: www.st.com. ECOPACK is an ST trademark.

9.1 PowerSSO-36 EPD

Figure 60. PowerSSO-36 EPD package outline

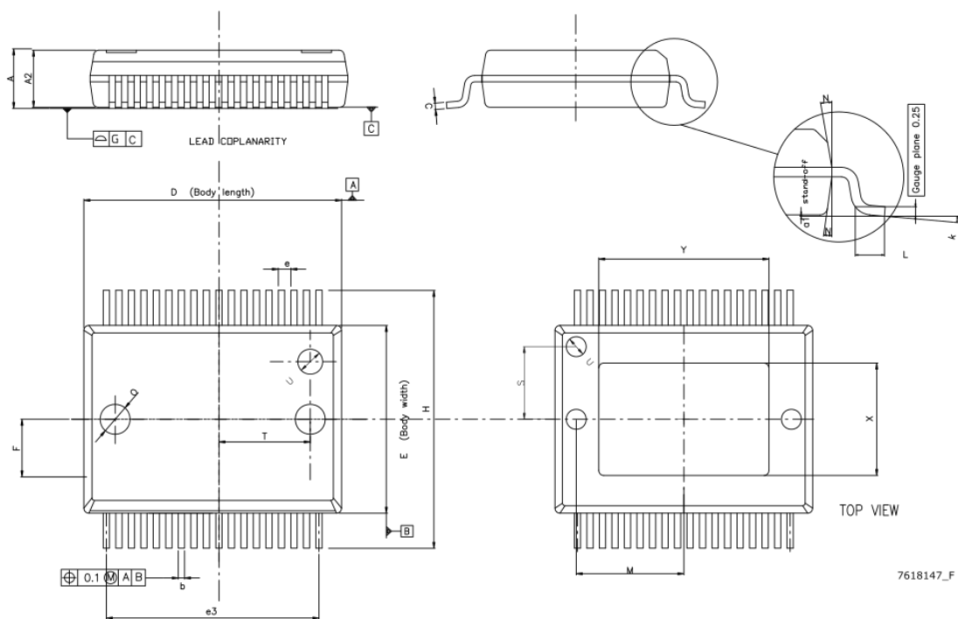

Table 9. PowerSSO-36 EPD package dimensions

Symbol	mm			Inches		
	Min.	Typ.	Max.	Min.	Typ.	Max.
A	2.15		2.47	0.085		0.097

Symbol	mm			Inches		
	Min.	Typ.	Max.	Min.	Typ.	
A2	2.15		2.40	0.085		0.094
a1	0.00		0.10	0.000		0.004
b	0.18		0.36	0.007		0.014
c	0.23		0.32	0.009		0.013
D	10.10		10.50	0.398		0.413
E	7.40		7.60	0.291		0.299
e		0.5			0.020	
e3		8.5			0.335	
F		2.3			0.091	
G			0.10			0.004
H	10.10		10.50	0.398		0.413
h			0.40			0.016
k	0		8 degrees	0		8 degrees
L	0.60		1.00	0.024		0.039
M		4.30			0.169	
N			10 degrees			10 degrees
O		1.20			0.047	
Q		0.80			0.031	
S		2.90			0.114	
T		3.65			0.144	
U		1.00			0.039	
X	4.10		4.70	0.161		0.185
Y	4.90		7.10	0.193		0.280

9.2 PowerSSO-36 with exposed pad up

Figure 61. PowerSSO-36 EPU package outline

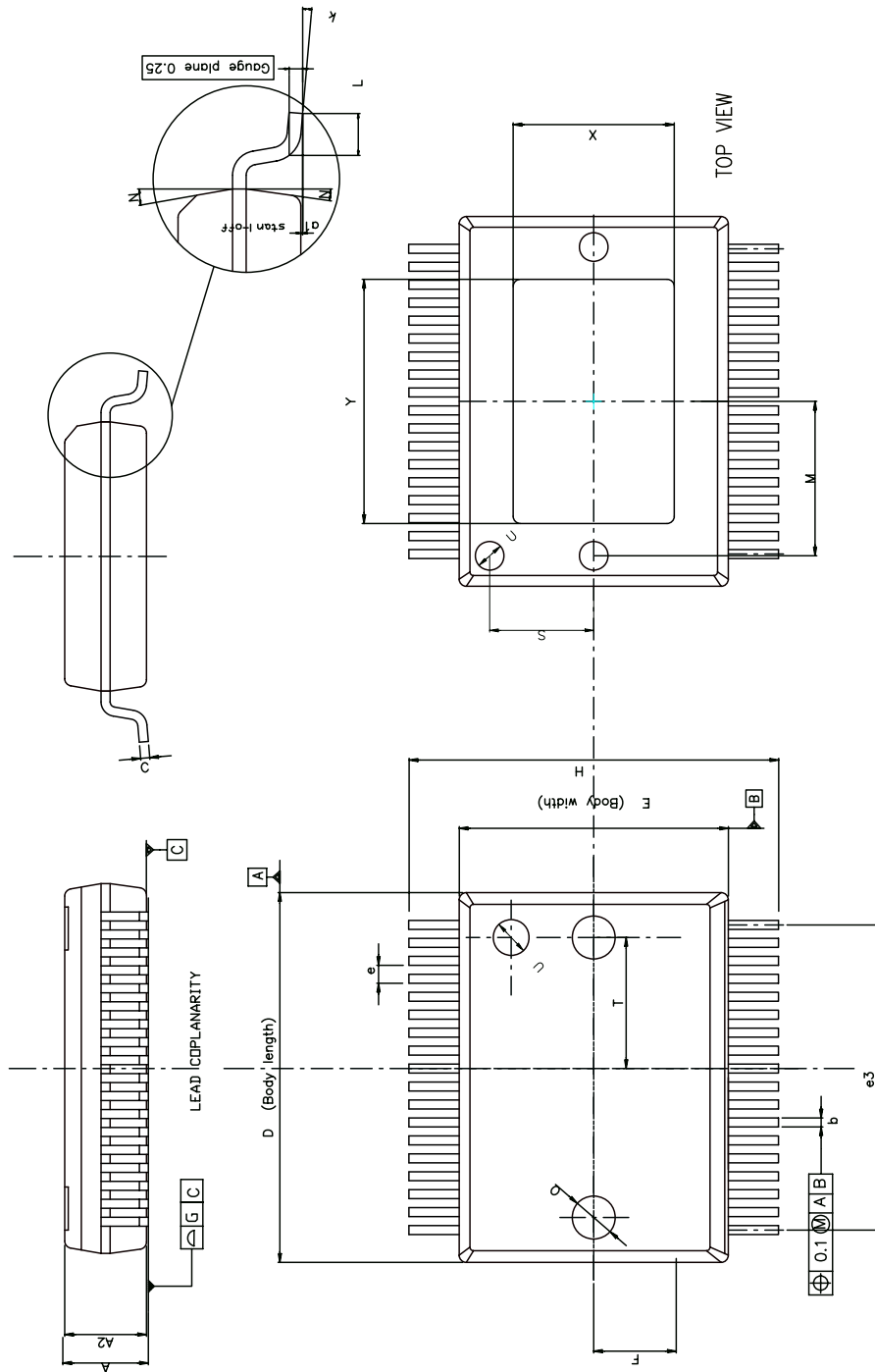

7618147_6

Table 10. PowerSSO-36 EPU package mechanical data

Symbol	mm			Inches		
	Min.	Typ.	Max.	Min.	Typ.	Max.
A	2.15	-	2.45	0.085	-	0.096
A2	2.15	-	2.35	0.085	-	0.093
a1	0	-	0.10	0	-	0.004
b	0.18	-	0.36	0.007	-	0.014
c	0.23	-	0.32	0.009	-	0.013
D	10.10	-	10.50	0.398	-	0.413
E	7.40	-	7.60	0.291	-	0.299
e	-	0.5	-	-	0.020	-
e3	-	8.5	-	-	0.335	-
F	-	2.3	-	-	0.091	-
G	-	-	0.10	-	-	0.004
H	10.10	-	10.50	0.398	-	0.413
h	-	-	0.40	-	-	0.016
k	0	-	8 degrees	-	-	8 degrees
L	0.60	-	1.00	0.024	-	0.039
M	-	4.30	-	-	0.169	-
N	-	-	10 degrees	-	-	10 degrees
O	-	1.20	-	-	0.047	-
Q	-	0.80	-	-	0.031	-
S	-	2.90	-	-	0.114	-
T	-	3.65	-	-	0.144	-
U	-	1.00	-	-	0.039	-
X	4.10	-	4.70	0.161	-	0.185
Y	6.50	-	7.10	0.256	-	0.280

Revision history

Table 11. Document revision history

Date	Revision	Changes
02-Jul-2008	1	Initial release.
03-Oct-2008	2	Updated AMR table Updated Chapter 4: Characterization curves on page 12 Added Figure 48: Test board (TDA7491HV) layout on page 29 Updated Figure 49: PowerSSO-36 EPD outline drawing on page 30 and Table 6: PowerSSO-36 EPD dimensions on page 31 Updated Figure 50: Applications circuit for class-D amplifier on page 32
29-Jun-2009	3	Updated text concerning oscillator R and C in Section 3.3: Electrical specifications on page 10 Updated VOVP minimum value, added VUVP maximum value, updated STBY and MUTE voltages in Table 5: Electrical specifications on page 10 Updated equation for fSW Table 5 on page 10 Updated Figure 50: Applications circuit for class-D amplifier on page 32
03-Sep-2009	4	Added text for exposed pad in Figure 2 on page 8 Added text for exposed pad in Table 2 on page 9 Updated exposed pad Y (Min) dimension in Table 6 on page 31 Updated supply voltage for pin DIAG pull-up resistor in Section 7.8 on page 40.
24-Mar-2011	5	Updated Features Updated Section 3: Electrical specifications Removed filter less operation Extended the temperature range to -40 to +85°C.
12Sep-2011	6	Updated OUTNA in Table 2: Pin description list
20-Feb-2014	7	Updated order code Table 1 on page 1
04-Jul-2018	8	Added PowerSSO-36 EPU silhouette in cover page, Section 2.3 Pinout (EPU), Section 2.4 Pin list (EPU) and Section 9.2 PowerSSO-36 with exposed pad up.
05-Oct-2018	9	Updated product summary table in cover page.
23-Feb-2021	10	Updated Figure 2. Pin connections (top view) , Section 2.3 Pinout (EPU) , Table 2. Pin description list .

Contents

1	Device block diagram	2
2	Pin description	3
2.1	Pinout (EPD)	3
2.2	Pin list (EPD)	4
2.3	Pinout (EPU)	5
2.4	Pin list (EPU)	6
3	Absolute maximum ratings	7
4	Electrical specifications	8
5	Characterization curves	10
5.1	4 Ω load at VCC = 14 V	10
5.2	6 Ω load at VCC = 16 V	16
5.3	8 Ω load at VCC = 18 V	23
6	Test board	31
7	Application circuit	32
8	Application information	33
8.1	Mode selection	33
8.2	Gain setting	34
8.3	Input resistance and capacitance	35
8.4	Internal and external clocks	35
8.4.1	Master mode (internal clock)	35
8.4.2	Slave mode (external clock)	36
8.5	Modulation	36
8.6	Reconstruction low-pass filter	37
8.7	Protection functions	38
8.8	Diagnostic output	38
8.9	Heatsink requirements	39
9	Package information	40
9.1	PowerSSO-36 exposed pad down	40
9.2	PowerSSO36 EPU package information	42



Revision history44

List of tables

Table 1.	Pin description list	4
Table 2.	Pin description list	6
Table 3.	Absolute maximum ratings	7
Table 4.	Thermal data	7
Table 5.	Electrical specifications	8
Table 6.	Mode settings	33
Table 7.	Gain settings	34
Table 8.	How to set up SYNCLK	36
Table 9.	PowerSSO-36 EPD package dimensions	40
Table 10.	PowerSSO-36 EPU package mechanical data	43
Table 11.	Document revision history	44

List of figures

Figure 1.	Internal block diagram (showing one channel only)	2
Figure 2.	Pin connections (top view)	3
Figure 3.	Pin connections (top view)	5
Figure 4.	Output power vs. supply voltage	10
Figure 5.	THD vs. output power (1 kHz)	10
Figure 6.	THD vs. output power (100 Hz)	11
Figure 7.	THD vs. frequency	11
Figure 8.	Frequency response	12
Figure 9.	Crosstalk vs. frequency	12
Figure 10.	FFT performance (0 dB)	12
Figure 11.	FFT performance (-60 dB)	13
Figure 12.	Power supply rejection ratio vs. frequency	13
Figure 13.	Power dissipation and efficiency vs. output power	13
Figure 14.	Closed-loop gain vs. frequency	14
Figure 15.	Current consumption vs. voltage on pin MUTE	14
Figure 16.	Attenuation vs. voltage on pin MUTE	14
Figure 17.	Current consumption vs. voltage on pin STBY	15
Figure 18.	Attenuation vs. voltage on pin STBY	15
Figure 19.	Output power vs. supply voltage	16
Figure 20.	THD vs. output power (1 kHz)	16
Figure 21.	THD vs. output power (100 Hz)	17
Figure 22.	THD vs. frequency	17
Figure 23.	Frequency response	18
Figure 24.	Crosstalk vs. frequency	18
Figure 25.	FFT performance (0 dB)	19
Figure 26.	FFT performance (-60 dB)	19
Figure 27.	Power supply rejection ratio vs. frequency	20
Figure 28.	Power dissipation and efficiency vs. output power	20
Figure 29.	Closed-loop gain vs. frequency	20
Figure 30.	Current consumption vs. voltage on pin MUTE	21
Figure 31.	Attenuation vs. voltage on pin MUTE	21
Figure 32.	Current consumption vs. voltage on pin STBY	22
Figure 33.	Attenuation vs. voltage on pin STBY	22
Figure 34.	Output power vs. supply voltage	23
Figure 35.	THD vs. output power (1 kHz)	23
Figure 36.	THD vs. output power (100 Hz)	24
Figure 37.	THD vs. frequency	24
Figure 38.	Frequency response	25
Figure 39.	Crosstalk vs. frequency	25
Figure 40.	FFT performance (0 dB)	26
Figure 41.	FFT performance (-60 dB)	26
Figure 42.	Power supply rejection ratio vs. frequency	27
Figure 43.	Power dissipation and efficiency vs. output power	27
Figure 44.	Closed-loop gain vs. frequency	28
Figure 45.	Current consumption vs. voltage on pin MUTE	28
Figure 46.	Attenuation vs. voltage on pin MUTE	29
Figure 47.	Current consumption vs. voltage on pin STBY	29
Figure 48.	Attenuation vs. voltage on pin STBY	30
Figure 49.	Test board (TDA7491HV) layout	31
Figure 50.	Application circuit for class-D amplifier	32
Figure 51.	Standby and mute circuits	33
Figure 52.	Turn-on/off sequence for minimizing speaker “pop”	34

Figure 53.	Device input circuit and frequency response	35
Figure 54.	Master and slave connection	36
Figure 55.	Unipolar PWM output	37
Figure 56.	Typical LC filter for an 8 Ω speaker	37
Figure 57.	Typical LC filter for an 4 Ω speaker	38
Figure 58.	Behavior of pin DIAG for various protection conditions	38
Figure 59.	Power derating curves for PCB used as heatsink	39
Figure 60.	PowerSSO-36 EPD package outline	40
Figure 61.	PowerSSO-36 EPU package outline	42

IMPORTANT NOTICE – PLEASE READ CAREFULLY

STMicroelectronics NV and its subsidiaries (“ST”) reserve the right to make changes, corrections, enhancements, modifications, and improvements to ST products and/or to this document at any time without notice. Purchasers should obtain the latest relevant information on ST products before placing orders. ST products are sold pursuant to ST’s terms and conditions of sale in place at the time of order acknowledgement.

Purchasers are solely responsible for the choice, selection, and use of ST products and ST assumes no liability for application assistance or the design of Purchasers’ products.

No license, express or implied, to any intellectual property right is granted by ST herein.

Resale of ST products with provisions different from the information set forth herein shall void any warranty granted by ST for such product.

ST and the ST logo are trademarks of ST. For additional information about ST trademarks, please refer to www.st.com/trademarks. All other product or service names are the property of their respective owners.

Information in this document supersedes and replaces information previously supplied in any prior versions of this document.

© 2021 STMicroelectronics – All rights reserved